



INSTRUMENTS
Gas Detection for Life!

T9-0112

OPERATING INSTRUCTION MANUAL FOR RIKEN INDOOR OXYGEN MONITOR MODEL OX-500

Operational Precautions

- Read and understand this instruction manual carefully before operating instrument.
- Follow the instruction manual when operate instrument.
- It may cause a trouble once instrument was operated without following the instruction manual.
- The safety and quality of the instrument is not guaranteed when the instrument gets trouble caused by not using properly or the user modifies instrument or the instrument was either repaired not by Riken Keiki Co., Ltd. nor service agents whose are not designated by Riken Keiki. Also, Riken Keiki Co., Ltd assumes not responsible for accidents that may occur as a result of the above reasons.

Introduction

Thank you for your order of Riken Oxygen Monoxide (OX) monitor, Model OX-500. The instrument is to notify the concentration of oxygen inability by alarm lamp or buzzer to prevent oxygen deficiency accident by any chance. To operate the instrument correctly, make sure to understand the manual before operating.

To assure safe and effective operation, the following outlines are used in this manual:

 **Danger**

This mark means that it may occur serious damage on the human's life or instruments if the instrument is used in improper way.

 **Warning**

If the instrument is not operated following the manual, it causes a serious damage on the human bodies or objects.

 **Caution**

If the instrument is not operated following the manual, it causes some damage on the human bodies or objects.

*** Note**

Advice on usage

Important Instruction for the Safety

Danger

- Gas sensitivity adjustment should be done periodically. Please contact our sales office or service agent for gas sensitivity adjustment.
- Make sure to install the instrument in the air. Otherwise, it cannot be measured correctly and there is a possibility to lead CO poisoning.

Danger

- The CO-500 should not be wired parallel to the wires which include power source, high hertz , high voltage and any other instruments' wires.
- The intersect wiring should be done when the CO-500 is to intersect with high hertz, high voltage and wires.
- During wiring work, do not put any stresses such as to pull, tighten or twist on cable.
- Installation is necessary in the place where has much noise.
- The instrument should not be modified.

Caution

- Do not poke the opening of sensor or buzzer with a sharply pointed thing, which may cause failure or breakage of the instrument. Also it may not be able to measure correctly.
- Do not pour water on the instrument, which may cause failure.
- Do not shock or vibrate strongly since it is the precision instrument.

Caution

- Install the instrument in the place where it doesn't get wet since the instrument is not water-proof nor for water use.
- Do not touch parts if you open it.
- Install the instrument without placing excessive power or power/signal cable.
- Do not close airway of the sensor.

Caution

- The instrument should be used in the room.
- The instrument should be used in a range of temperature and humidity (0-40°C RH90% below). Otherwise, it will not get a correct detection rate.

Table of Contents

	Page
1. Name of Each Part and Function	5
2. Place to Install	6
3. How to Install	8
3-1 How to Install	8
3-1-1 When Using Attached Mounting Panel.....	8
3-1-2 When Not Using Attached Mounting Panel	10
3-2 Take in Power Supply Directly	12
3-2-1 How to Connect AC Cable	12
3-2-2 Cable Using	15
4. How to Use	16
4-1 Operational Flow after Power Source is on	16
4-1-1 Self Diagnosis	16
4-1-2 Initial Clear	16
4-1-3 Air Adjustment Sign	16
4-2 Basic Function	16
4-2-1 Indication for Concentration	17
4-2-2 Gas Alarms	17
4-2-3 Scale Over	17
4-2-4 Indication when Trouble Occurs.....	18
5. User's Maintenance Mode	19
5-1 Air Adjustment	20
5-2 Alarm Point Confirmation	21
5-3 Alarm Summary Confirmation	22
5-4 Date & Time Confirmation* Set-up	24
5-5 Alarm Test	28

6. Connect Wiring	29
7. External Output Operation	29
7-1 External Output	29
7-2 4-20mA Output Chart	30
7-3 LED, Contact Point Output Chart	30
8. When Instrument is Not in a Good Condition	31
9. Specifications	32
10. Accessories	33
11. Warranty	34

1. Name of Each Part and Function

【 Front Side】

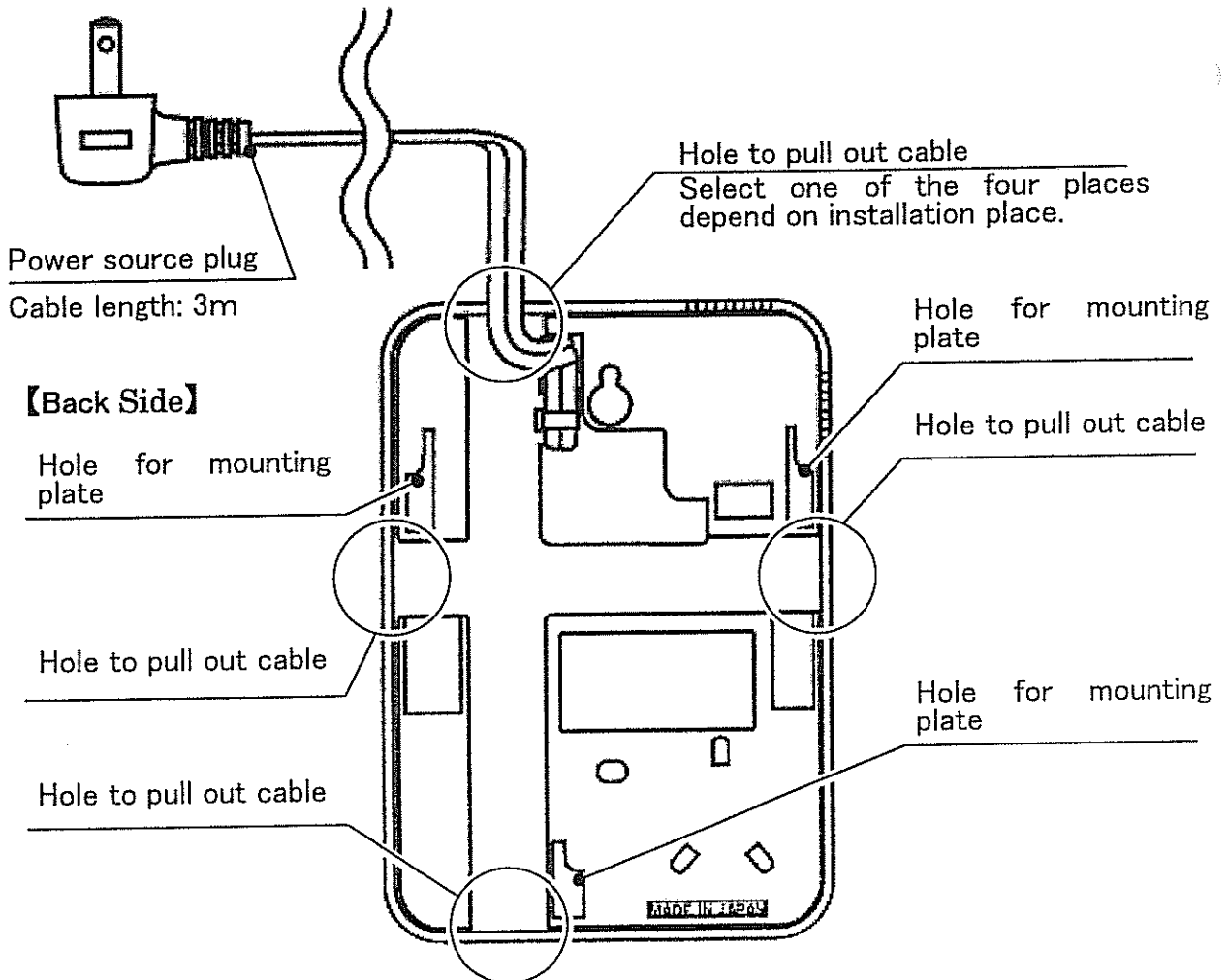
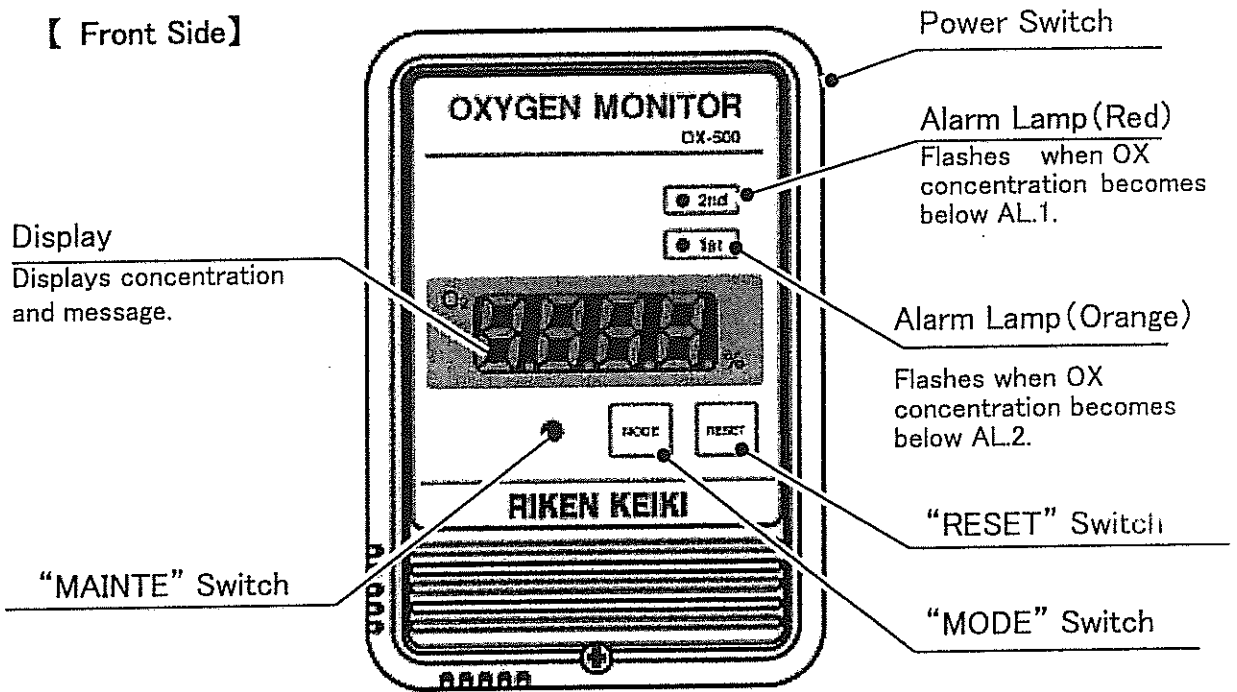

2. Place to Install

Install the instrument on the wall where 50~80cm away from the floor. (Make sure not to install the instrument where air blasting get directly from the air conditioning.)

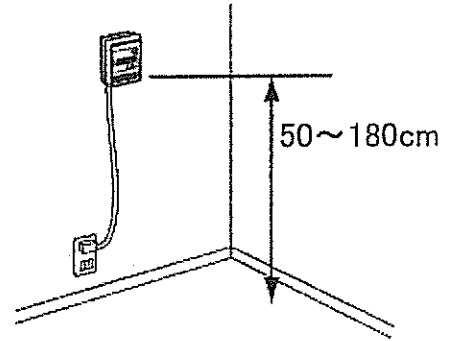

Please do not install the instrument in the following places.

1. Get direct sunlight or at outside

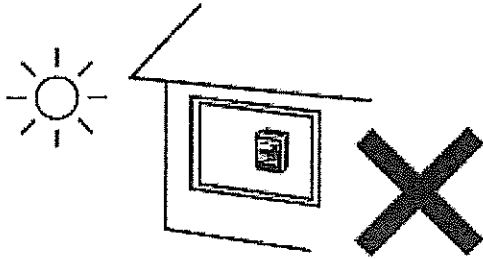

2. Easy to get wet

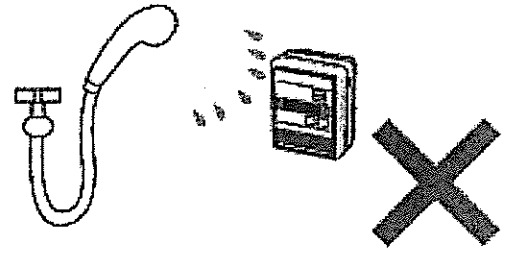

3. Get oily smoke, smoke or steam.

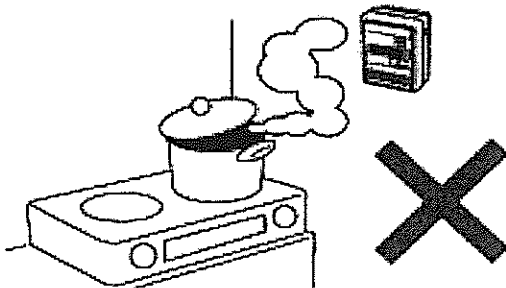

4. Below 0 °C , over 40 °C or temperature changes suddenly.

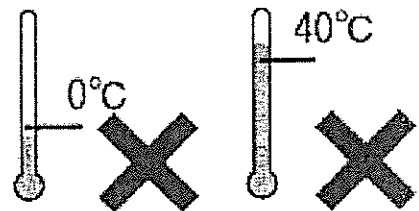

5. Have a lot of moisture, e.g. bathroom

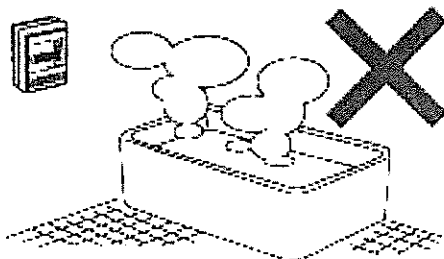

6. Back of curtain, concealed place or not to have a good ventilation

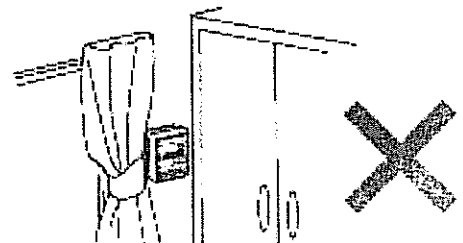

Cautions for Usage

1. Open the window and ventilate the air in the room.

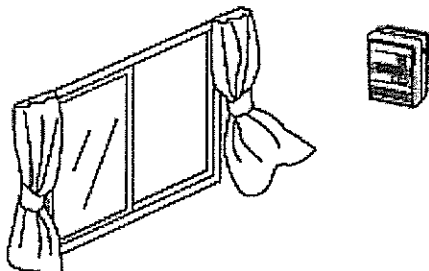

2. Plug in the power plug into the outlet and turn on the power source.

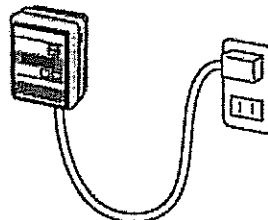

The display starts flashing 25 seconds later after all lamps are on.

3. The air adjustment should be done. Since it is not guaranteed whether the instrument reading is appropriate against the oxygen concentration when recovery from the power failure or after power switch is ON, make sure to execute the air adjustment. Please refer to the “Chapter 5 5-1 Air Adjustment”.

4. The air adjustment is important to keep accuracy of the instrument and should be done once every six months after air ventilation is completed well.

- ★ When the OX concentration decreases from the air concentration of 20.9% and it becomes below 19.0% [standard], the alarm lamp (orange) will start to flash and buzzer will start beeping



- ★ When OX concentration decreases again and becomes below 18.0% [standard], the alarm lamp (orange, red) will start to flash and the continuous buzzer sound will start beeping.



Caution

Since it is dangerous once alarm start beeping, make sure to open the window immediately for air ventilation.

3. How to Install

3-1 How to Install

Caution

Installation should be done before AC power source is connected. Otherwise, you will get an electrical shock.

3-1-1 When Using Attached Mounting Panel

- ① Fix attached panel to wall surface with attached screws (pan head screw or screw spike). Make sure the panel is not inclined. Basically it should be fixed at two places. Other two screw holes can be used if it is necessary.

* Note

When you install, an arrow mark, ↑ should be upper direction.

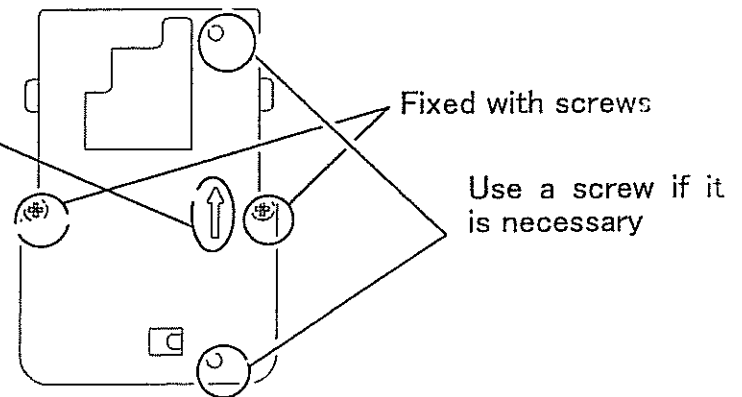

Caution

Fix the panel to the wall, which is strong enough and doesn't vibrate.

- ② Press the body of the instrument so that the projections (3 places) of the attached panel can get into the hole to plug attached panel of the back side of bottom case and slide body of the instrument to a lower direction with the attached panel close to the bottom case.

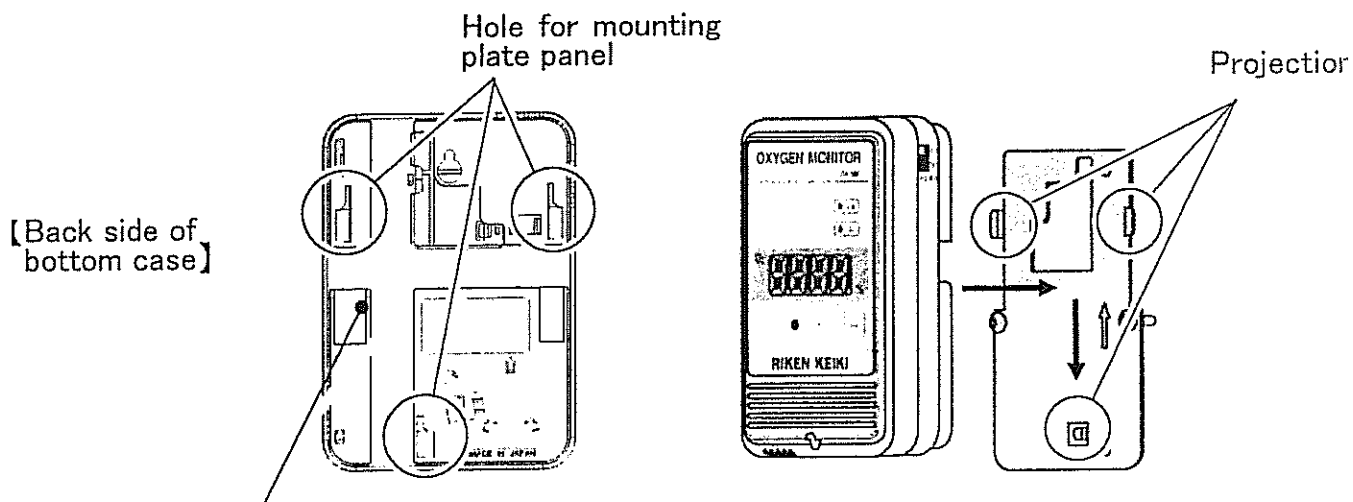

Depending on the installation place, the power supply plug should be pulled out along with a hole to pull out cable (trench).

- ③ Confirm whether the back of the lower part of the case is attached closely to the attached panel.

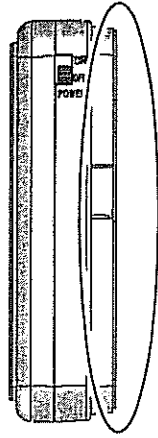

◎ Good example

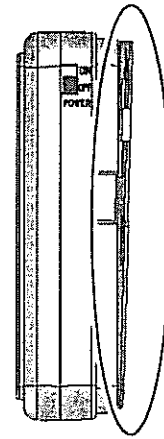

× Bad example

⚠ Caution

When you install, be careful not to pinch the cable between the body of the instrument and the attached panel.

- ④ The air adjustment will be done when the instrument becomes measurement mode after plugging in the AC code into the outlet and turn on the power source.

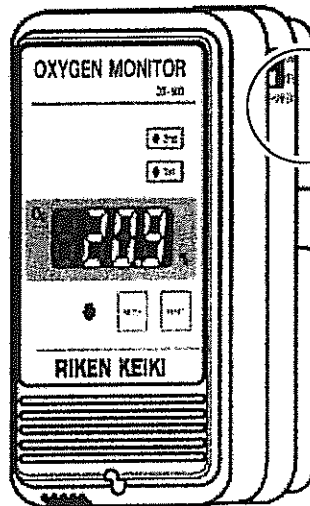

ON

OFF

Power source switch

⚠ Caution

The concentration display flashes until the air adjustment is completed. Make sure to take the air adjustment procedure each time when you turn on the power source switch or power failure of the instrument.

3-1-2 When Not Using Attached Mounting Panel

- ① Loosen the screw of the lower part of the front body of the instrument and open the upper case

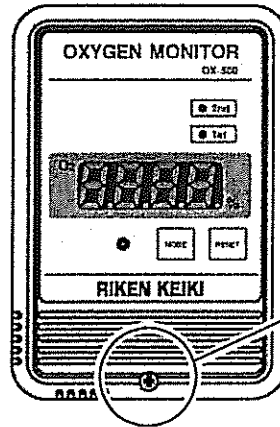

Loosen the screw

- ② Open the upper part case and take off the connector which is connected to the bottom case.

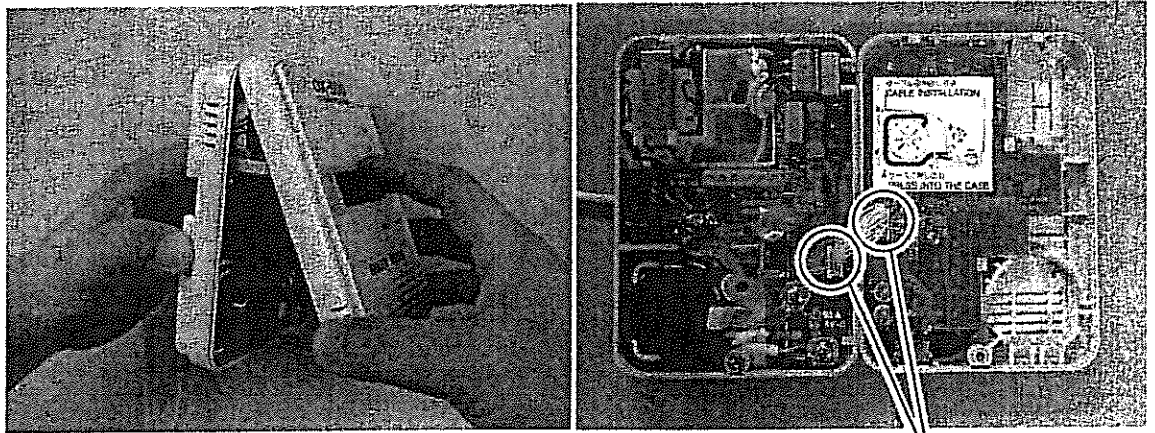

Connector

Caution

- Open the case without breaking the wires and connector since each case is connected by the connector.
- Make sure not to pull the connector when you pull out the wire.

- ③ Fix on two places of the bottom case with attached two screws (pan head small screw or screw spike.) At this time, confirm whether the instrument is not inclined

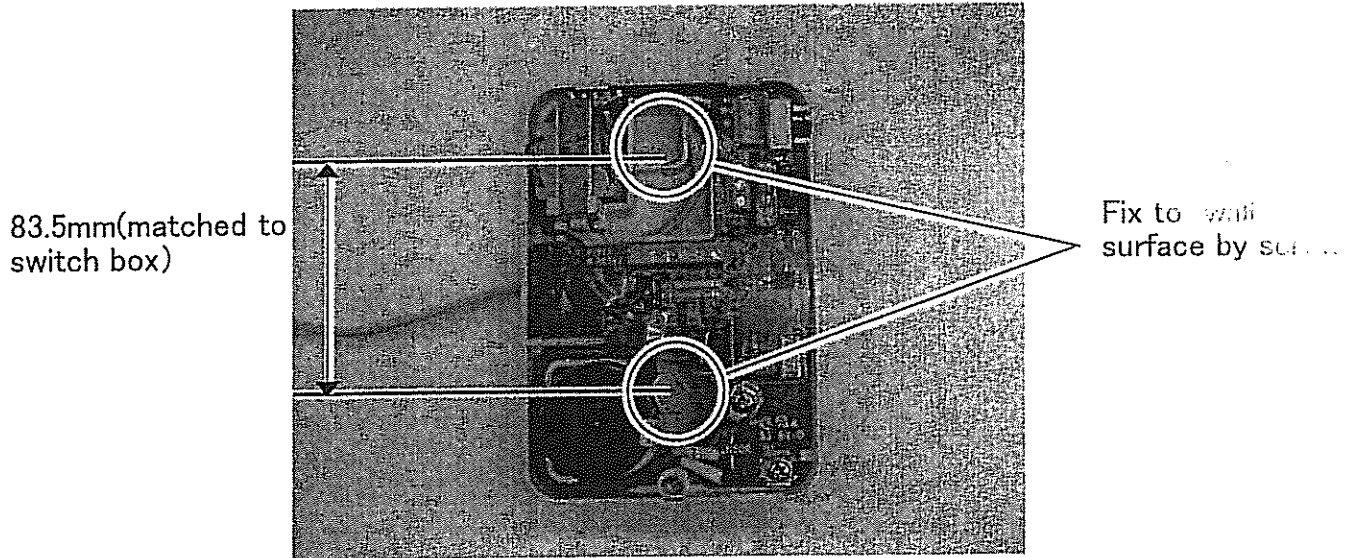

⚠ Caution

- Fix the panel to the wall, which is strong enough and doesn't vibrate.
- When you install, be careful not to pinch the cable between the body of the instrument and the wall.

- ④ Connect the upper and bottom cases with the connector and close the case. At this time, confirm whether the two clicks of the case are snapped on the bottom case (the upper and bottom case should be attached closely) and the cable is not stick out from the case. Screw the lower part of the front body of the instrument.

- ⑤ Turn on the power source.

⚠ Caution

- Install the connector correctly. Otherwise, the gas cannot be detected properly.
- When you install the connector, install  (convex) part at the left side.

3-2 Take in Power Source Directly

Caution

Installation should be done before AC power source is connected. Otherwise, you will get an electrical shock.

3-2-1 How to Connect AC Cable

- ① Loosen screws of lower part of the front body of the instrument, and open the upper case.
- ② Cut the cable clamp which prevent the AC code to pull out and take out the AC cable from the terminal block.

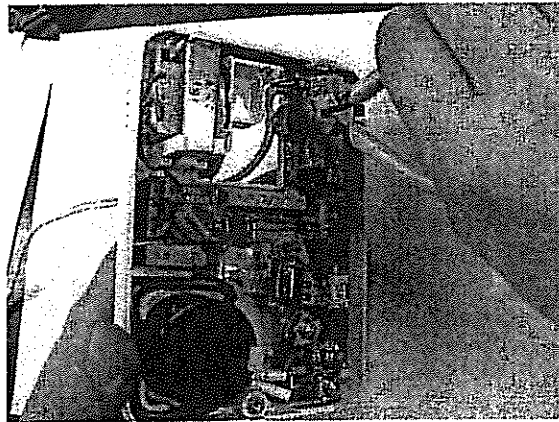

- ③ Let cable clamp through the upper part of the hole to pull out cable and fasten the cable clamp halfway.

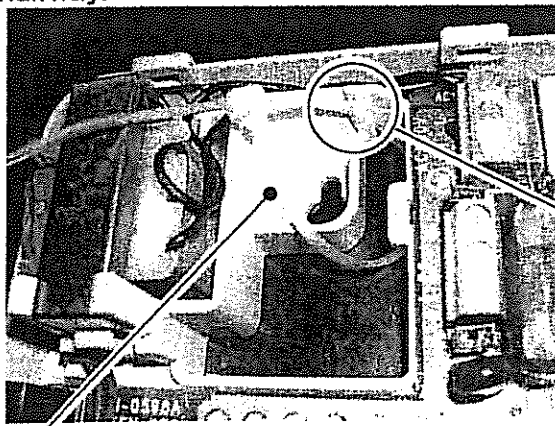

Hole to pull out cable

Cable Clamp

* Note

Let the cable clamp through the back of the case.

④ Fix the power source cable with the cable clamp.

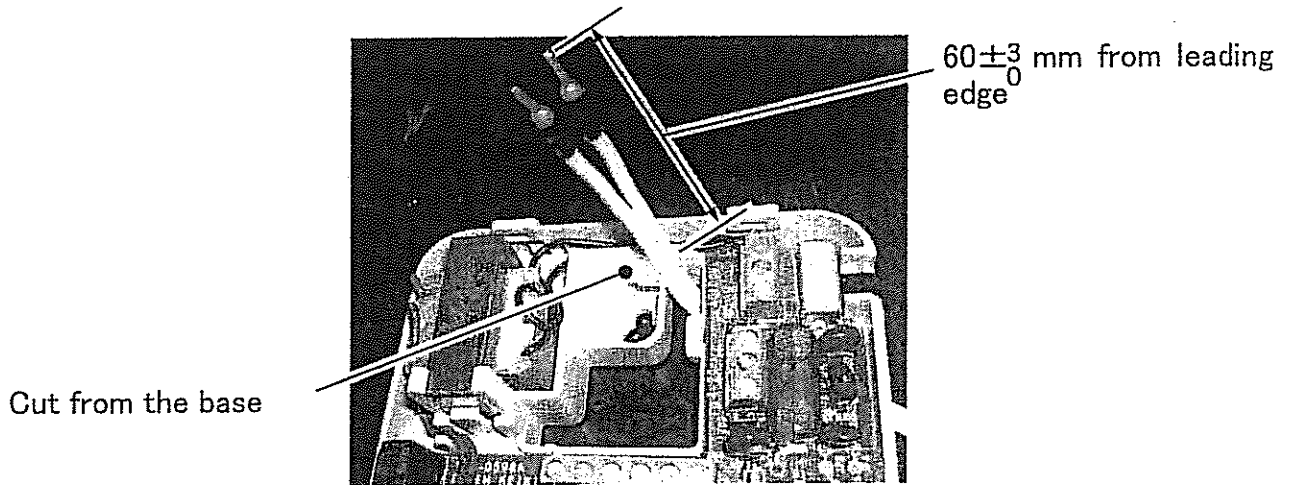

【Back of the case】

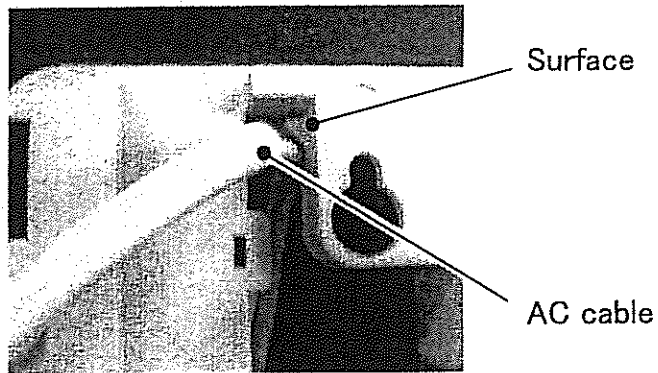

* Note

- The position to fasten the cable clamp is $60 \pm \frac{3}{0}$ mm from the leading edge of the cable.
- Fix the power source cable to contact to the surface of the installation position.
- After fixing the power source cable, cut the remaining of cable from the base.

⑤ Let the cable clamp through the hole to pull out the cable, and fix the power cable.

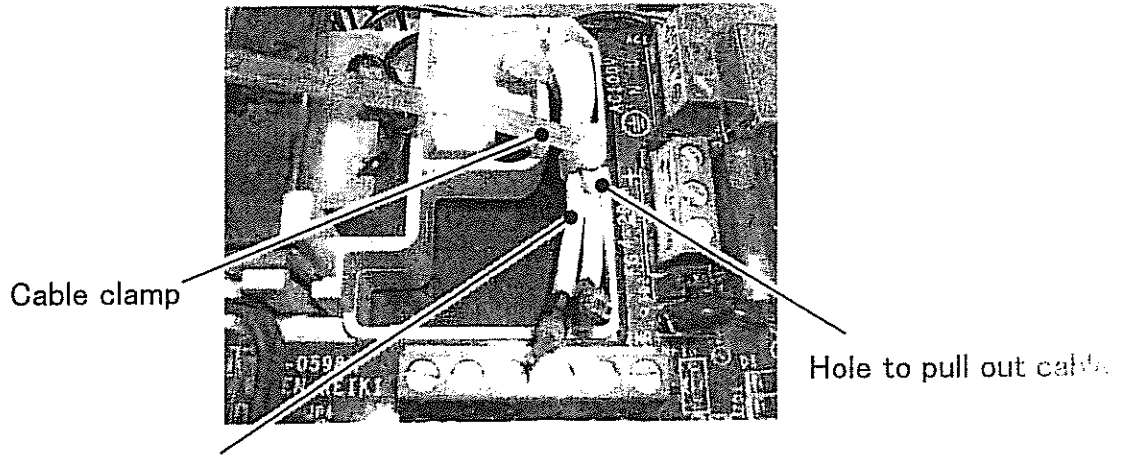

AC cable (Let the cable clamp through beneath of the hole to pull out cable)

*** Note**

- Let the cable clamp through the back of the case.
- Put the power cable beneath of the hole to pull out cable and fix it to contact with the surface of the installation position.
- After fixing the power source cable, cut the remaining of cable clamp from the base.

⑥ Connect the cable terminal to the terminal block

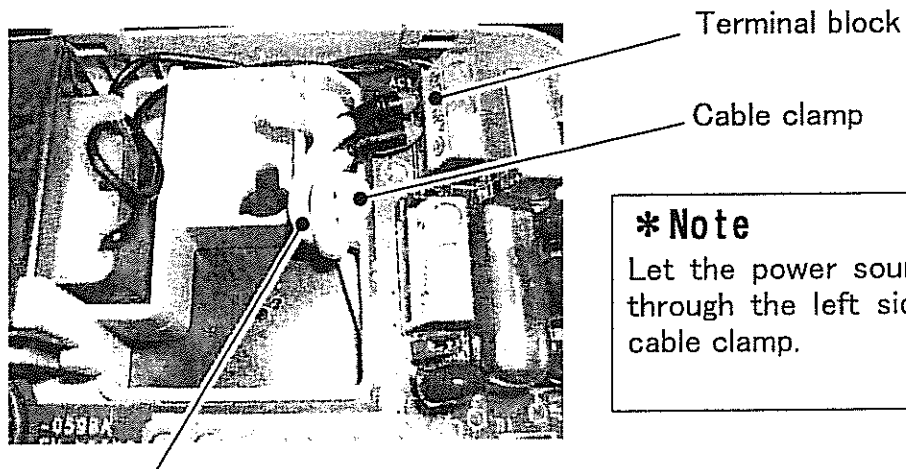

*** Note**

Let the power source cable through the left side of the cable clamp.

Power source cable (Let the power source cable through the left side of the cable clamp)

⚠ Caution

The cable clamp, which will be used, should be 4mm in width and within 1.5mm thickness. Please refer to 3-2-2 for adjustment cable.

- ⑦ Close the case
- ⑧ Turn the power ON

⚠ Caution

- Cables, except for AC cable, should be basically wired into the wall via switch box. In case the cable will be wired outside of the wall, fix the cable where the unnatural power will be placed since there is no cable through cramp.
- Do not pull the cable when you pull out the connector which connect each case. If you do, it may cause a loose connection.

⚠ Caution

The power source code should be cramped to the case of the body so that the terminal connecting part (terminal block) should not take any overloading caused by pulling out the cable.

3-2-2 Cable Using

① Connectable cable:

Single wire : 0.14mm²~1.5mm²

Twisted wire : 0.14mm²~1.5mm²

Length of bare wire: 6mm

Cable finished dimension is not over ϕ 7.0mm

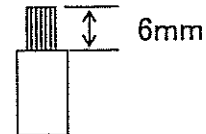

② Specification of terminal block

Voltage rating : AC250V

Current rating : 13A

Torque to tighten up screw: 5~8kg

Compatible driver : Minus driver, width of leading edge : Below 3mm

Compatible stick : Model AI series (Phoenix)

Compatible clamping tool : CRIMPFOX UD 6(Phoenix)

4. How to Use

4-1 Operational Flow after Power Source is On

4-1-1 Self Diagnosis

Confirm the setting status of the indicator after the power source is on.



4-20mA output: 17.4mA fixation

4-1-2 Initial Clear

Initial clear is the warm up time before sensor output becomes stable.

The time for the initial clear is 25 seconds including the self diagnosis time.



4-20mA output: 17.4mA fixation

4-1-3 Air Adjustment Sign

When the power source is on or returning from the power failure, the instrument urges to air adjustment by flashing the concentration display at the measuring mode.

All functions are working on. even the air adjustment sign is displayed.

Display of flashing the concentration rate will be released once the "Air Adjustment" is completed.

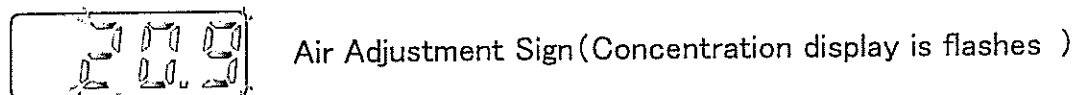

After "Air Adjustment"

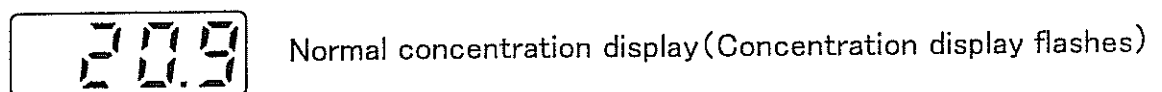

※The normal alarm operation will be conducted while the air adjustment sign is on.

4-2 Basic Function

4-2-1 Indication for Concentration

Gas concentration will be displayed in "Green".



Indication range : 0.0~25.0

4-20mA output: 4~20mA (Depending on gas concentration)

4-2-2 Gas Alarm

The alarm start flashing and buzzer will beep when the gas concentration rate is less than the alarm setting rate.

The Model OX-500 has 2 decrease alarms function (L/LL).



※ The standard of alarm operation is the automatic return after self maintenance reset. The indication of the concentration will flash when alarm beeps and will be lighted after reset. (1st time "orange", 2nd time "red")

The alarm lamp will flash when alarm beeps and the lights will be on after it is reset. The lights will be off when concentration rate becomes below the alarm point. The alarm contact point will be on when it surpasses certain alarm point and will be released after alarm is reset.

4-20mA output: 4~20mA (depending on gas concentration)

4-2-3 Scale Over

During the measurement, it will be displayed when the instrument detects the gas which exceeds full scale.

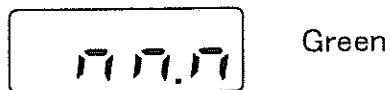

4-20mA output: 20~22mA

4-2-4 Indication When Trouble Occurs

There are two kinds of troubles, i.e. memory error and breaking of wire error. The error notice will be displayed and buzzer will beep when error occurs.

① Memory error

Turn off the power is the only way to release the memory error.

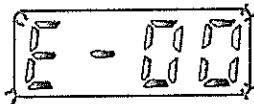

Red (Flashing)

Memory error: Will be happened by the result of self diagnosis when power is on.

4-20mA output: 0.5mA

② Breaking of Wire Error

The sounds of buzzer will be OFF by pressing "RESET" button.

The display of breaking of wire error will be released by fixing the condition of breaking the sensor.

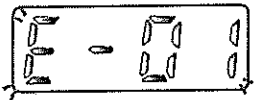

Red (Flashing)

Breaking of: Will be happened by breaking wire error the sensor while it is measuring.



Return from the sensor breaking



Green

It takes 25 seconds to warm up the instrument after error is corrected caused by breaking of wire error.

4-20mA output: 17.4mA

5. User's Maintenance Mode

Once you press the "MODE" button continuously for 3 seconds when the "Measuring Mode" is indicated, the LEDs turn to the "User Maintenance Mode".

The Model OX-500 has five user's maintenance modes: "Air Adjustment", "Alarm Point Confirmation", "Alarm Summary Confirmation", "Date & Time Confirmation Set-up", and "Alarm Test".

The following items can be selected by pressing the "MODE" switch when the menu is displayed.

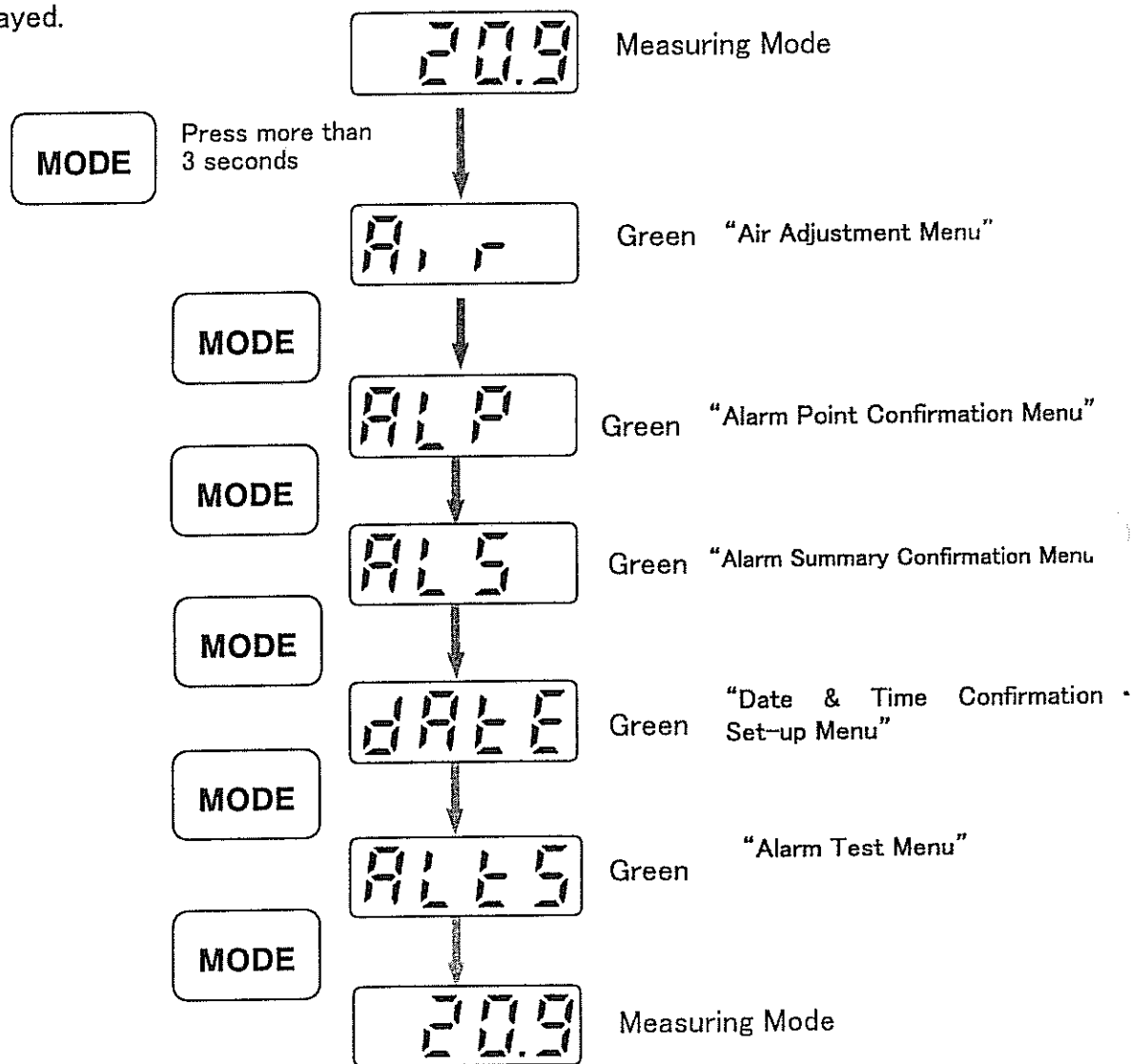

- ※ While the "User's Maintenance Mode" is displayed on instrument screen and if you don't operate more than 1 minute, notice of completion bell will ring and it will return to the "Measuring Mode".
- Even when the screen shows the "User Maintenance Mode", instrument continues to monitor gas concentration. It will return to the "Measuring Mode" once the alarm starts beeping. (Except for the "Air Adjustment" and the "Alarm Test".)
- ※ Once the "User Maintenance Mode" was set while gas alarm is on or the instrument is in trouble, it cannot monitor the gas concentration for 30 seconds. (It is for delaying the alarm beeping until the air adjustment will be done.)

5-1 Air Adjustment

It is the mode to control the present gas concentration to "20.9".

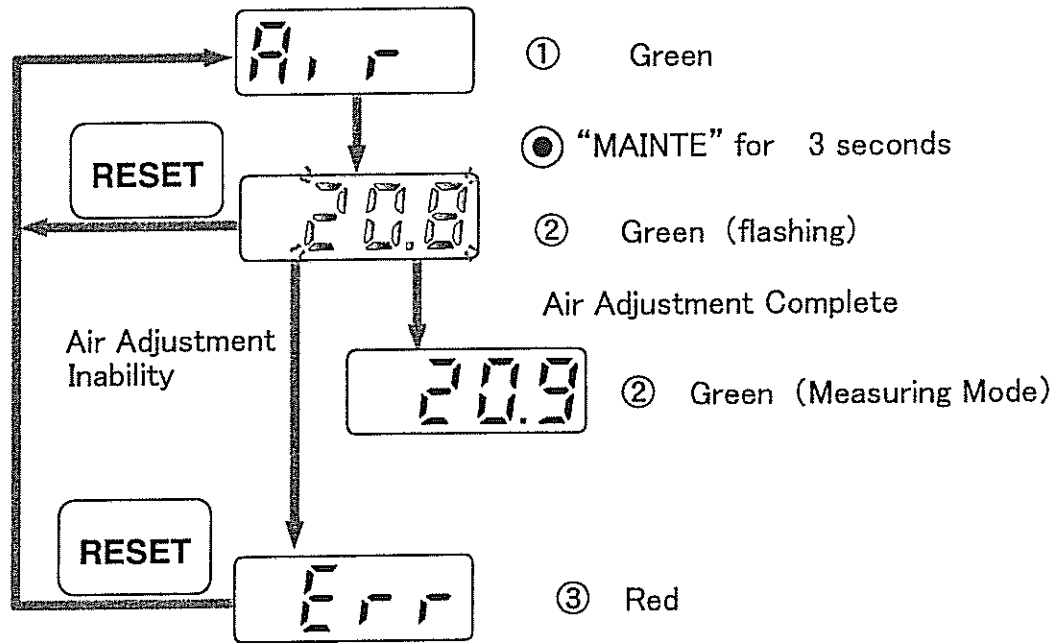

① «Air Adjustment Menu»

Press the "MODE" button, the LEDs display the "Alarm Point Confirmation Menu". Once you press the "MAINTE" button for 3 seconds, the "Air Adjustment" starts.

② «In the Middle of Air Adjustment»

The current gas concentration display screen appears and the screen start flashing. Once you press the "RESET" button, it returns to the "Air Adjustment Menu" after interrupting the air adjustment.

Once the air adjustment is completed, you will hear the completion sounds and it will return to the "Measuring Mode".

The "Error" sign will be displayed when the air adjustment is not completed.

③ «Error Display»

It returns to the "Air Adjustment Menu" once you press the "RESET" button.

Warning

•The air adjustment should be operated in a fresh air.

5-2 Alarm Point Confirmation

It is a mode to confirm the alarm point.

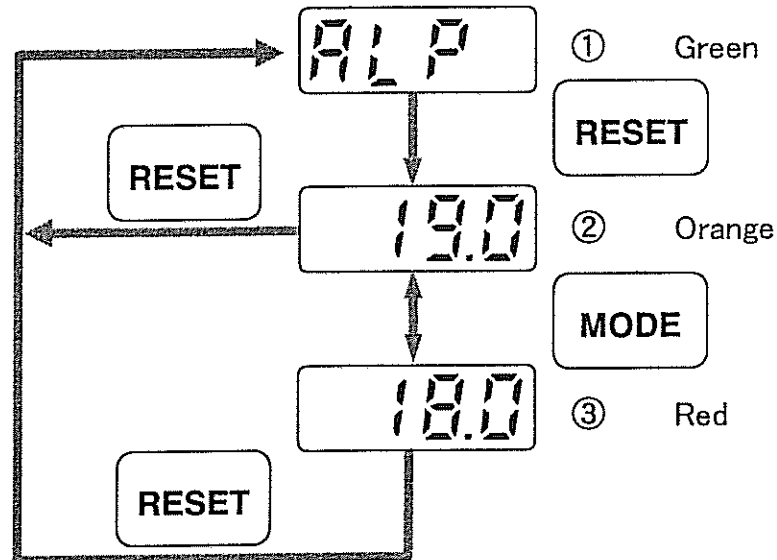

① «Alarm Point Menu»

Press the "MODE" button, the LEDs display the "Alarm Summary Menu".
Press the "RESET" button, the LEDs display the "Alarm Confirmation".

② «Alarm Point Confirmation 1»

AL1 concentration will be displayed.
Press the "MODE" button, the LEDs display the "Alarm Point Confirmation 2".
When you press the "RESET" button, it return to the "Alarm Confirmation Menu".

③ «Alarm Point Confirmation 2»

AL2 concentration will be displayed.
Press the "MODE" button, the LEDs display the "Alarm Point Confirmation 2".
When you press the "RESET" button, it will return to the "Alarm Confirmation Menu".

5-3 Alarm Summary Confirmation

It is the mode to confirm the alarm summary. The indications are "Track Record No." (ALP1、ALP2...ALP0) "Gas Concentration", "Year", "Month & Date", "Time". It can confirm 10 cases maximum.

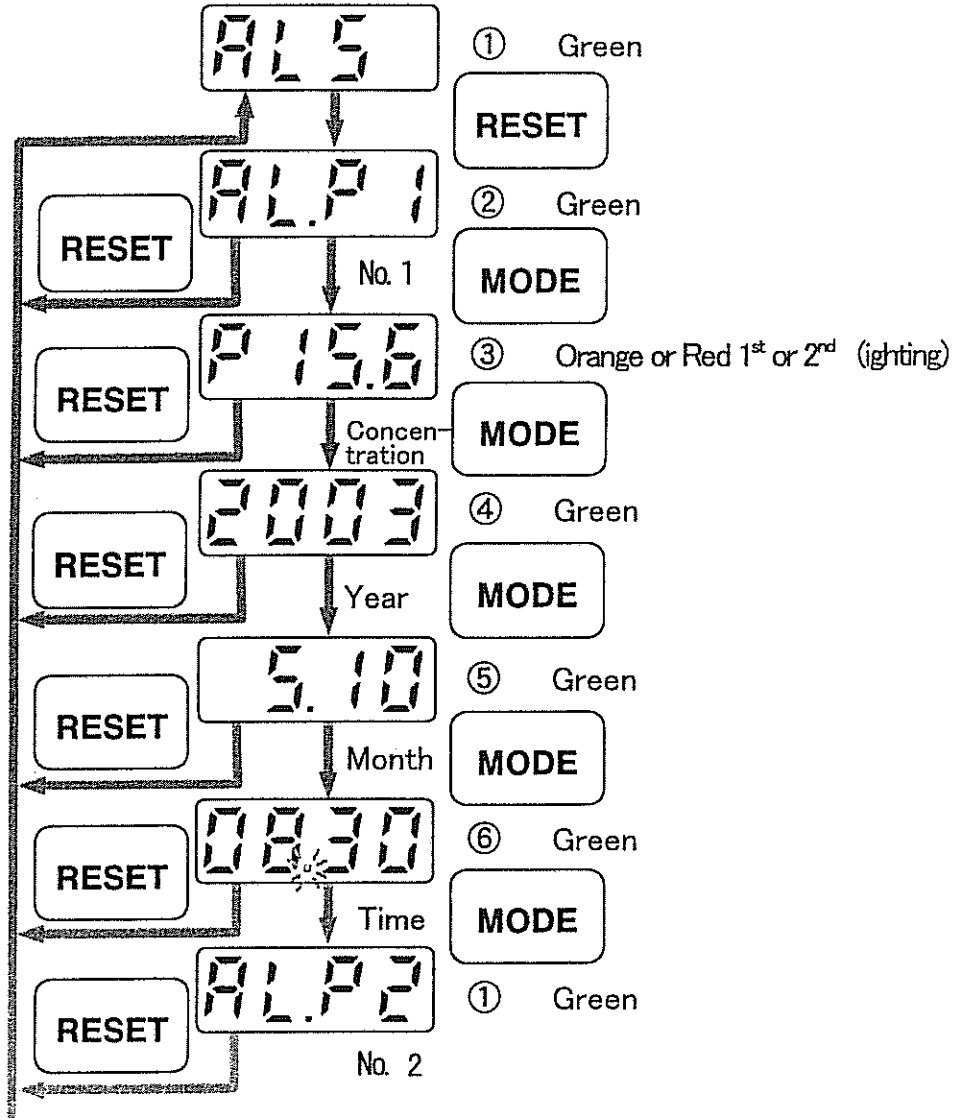

※Track Record No.1 (P1) will be the latest data.

① «Alarm Summary Confirmation Menu»

Press the "MODE" button, it goes to the "Date & Time • Set-up Menu". Press the "RESET" button, it goes to the "Indication of Truck Record". The alarm summary will be all cleared if you continue pressing the "MAINTE" button for 3 seconds when the "ALS" is indicated. (The "ALS" which is flashing, and once it is cleared, completion sounds will beep and light will be on.)

② <<Track Record Indication>>

Track record 1 (P1) will be displayed.

Press the "MODE" button, it goes to the "Indication for Concentration".

Press the "RESET" button, it goes to the "Alarm Summary Confirmation Menu"

③ <<Indication for Concentration>>

The Alarm Summary Concentration will be displayed.

Once the recorded concentration is in the 1st alarm time, the indication of the concentration will become orange. (1st LED flashing)

Once the recorded concentration is in the 2nd alarm time, the indication of the concentration becomes red (2nd LED flashing)

Press the "MODE" button, it goes to the "Indication for Year".

When you press the "RESET" button, it will return to the "Alarm Summary Confirmation Menu".

④ <<Year Indication>>

Year of the Alarm Summary will be displayed.

Press the "MODE" button, it goes to the "Month & Data Indication".

When you press the "RESET" button, it will return to the "Alarm Summary Confirmation Menu".

⑤ <<Month & Date Indication>>

Month & Date of the Alarm Summary will be displayed.

Press the "MODE" button, it goes to the "Time Indication".

When you press the "RESET" button, it will return to the "Alarm Summary Confirmation Menu".

⑥ <<Time Indication>>

Alarm Summary Time will be displayed.

("." flashes)

Press the "MODE" button, it goes to the next "Track Record Indication".

When you press the "RESET" button, it will return to the "Alarm Summary Confirmation Menu".

After that, along with the 「Track No. 1」2→3→...→9→0→1→... will be repeated.

※Track No. 1 (P1) will be the latest data.

5-4 Date & Time Confirmation Set-up

This is the mode to confirm and set up the date & time of the inner clock.

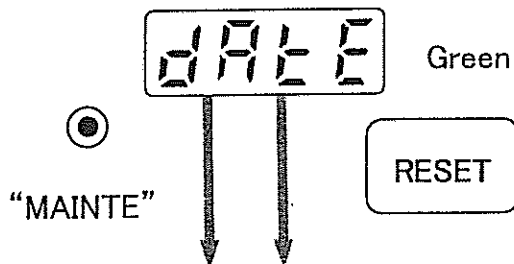

[Date & Time Setting Mode] [Date & Time Confirmation Mode]

① <<Date & Time Confirmation Set-up Menu>>

Press the "MODE" button, it goes to the "Alarm Test Menu".

Press the "RESET" button, it goes to the "Date & Time Confirmation Year".

Press the "MAINTE" button, it goes to the "Date & Time Set-Up Year".

【Date & Time Confirmation Mode】

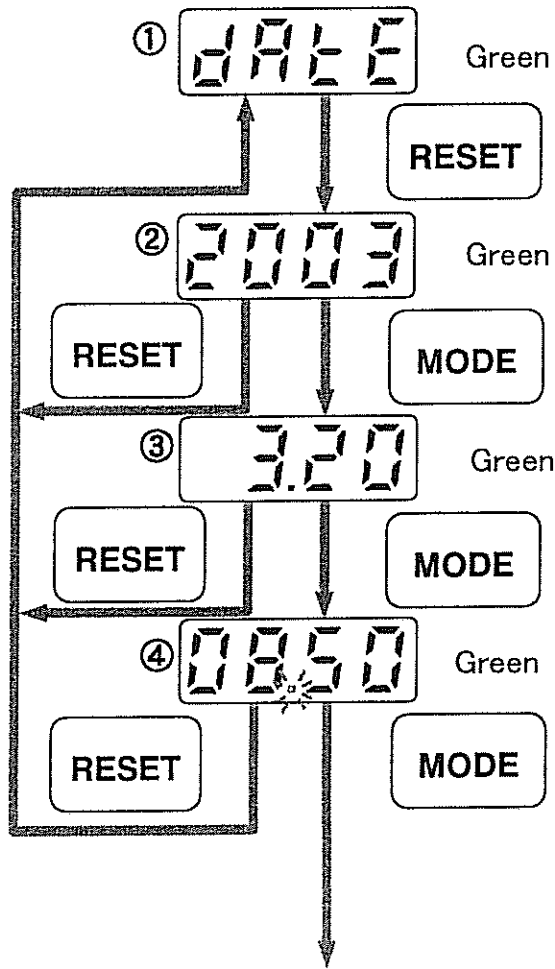

To "Date & Time Confirmation Year"

① <<Date & Time Confirmation Set-up Menu>>

When you press the "RESET" button, it will return to the "Date & Time Confirmation Year".

② <<Date & Time Confirmation Year>>

Current year will be displayed. Press the "MODE" button, it goes to the "Date & Time Confirmation Month & Date". When you press the "RESET" button, it will return to the "Date & Time Confirmation Set-up Menu".

③ <<Date & Time Confirmation Month & Date>>

Current date and time will be displayed. Press the "MODE" button, it goes to the "Date & Time Confirmation Time". When you press the "RESET" switch, it will return to the "Date & Time Confirmation Set-up Menu".

④ <<Date & Time Confirmation Time>>

Current date and time will be displayed. Press the "MODE" button, it goes to the "Date & Time Confirmation Time". When you press the "RESET" switch, it will return to the "Date & Time Confirmation Set-up Menu".

【Date & Time Set-up Mode】

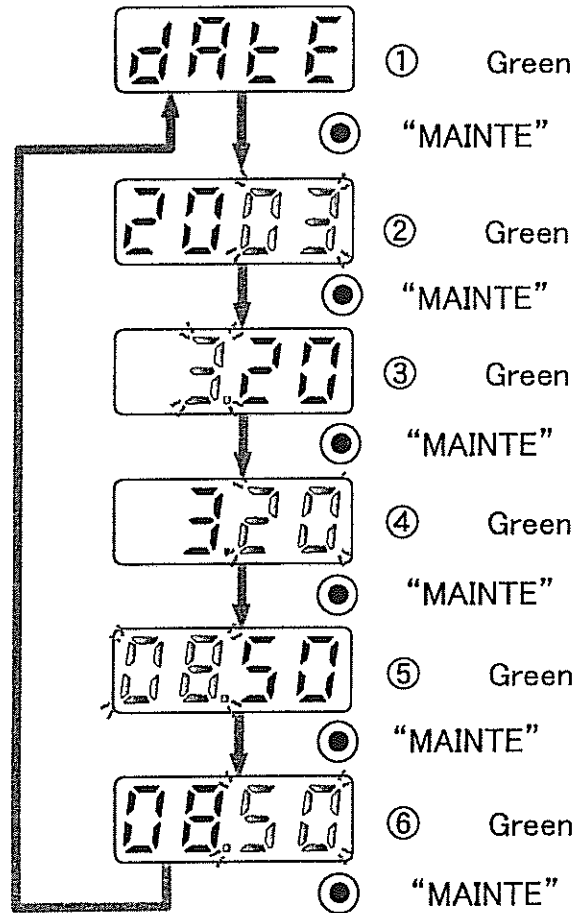

① <<Date & Time Confirmation・Set-up Menu>>

Press the "MAINTE" button, it goes to the "Date & Time Set-up Year".

② <<Date & Time Set-up Year>>

Current year will be displayed.

Press the "RESET" button and the Year which is indicated will go UP. (If you keep pressing it, the Year will go UP continuously.)

Press the "MODE" button and the Year which is indicated will go DOWN. (If you keep pressing it, the Year will go DOWN continuously.)

Press the "MAINTE" button and the "Date & Time Set-up Month" will appear.

※Year set-up range: 2000~2099

③ <<Date & Time Set-up Month>>

Current date will be displayed. (Indication for the Month will be flashed.)

Press the "RESET" button and the Month which is indicated will go UP. (If you keep pressing it, the Month will go UP continuously)

Press the "MODE" button and the Month which is indicated will go DOWN. (If you keep pressing it, the Month will go DOWN continuously)

Press the "MAINTE" button, it goes to the "Time Set-up Date" ..

※Month set-up range: 1~12

④ <<Date & Time Set-up Date>>

Current month & date will be displayed. (Indication for the Date will be flashed.)

Press the "RESET" button and the Date which is indicated will go UP. (If you keep pressing it, the Date will go UP continuously.)

Press the "MODE" button and the Date which is indicated will go DOWN. (If you keep pressing it, the Date will go DOWN continuously.)

Press the "MAINTE" button, it goes to the "Date & Time Set-up Hour".

※Date set-up range: 1~31 (differs depending on the set-up month)

⑤ <<Date & Time Set-up Hour>>

Current time will be displayed. (Indication for the Hour will be flashed.)

Press the "RESET" button and the Time which is indicated will go UP. (If you keep pressing it, the Time will go UP continuously.)

Press the "MODE" button and the Time which is indicated will go DOWN. (If you keep pressing it, the Time will go DOWN continuously.)

Press the "MAINTE" button, it goes to the "Date & Time Set-up Minute".

※Time set-up range: 00~23

⑥ <<Date & Time Set-up Minute>>

Current time will be displayed. (Indication for the Minute will be flashed.)

Press the "RESET" button and the Minute which is indicated will go UP. (If you keep pressing it, the minute will go UP continuously.)

Press the "MODE" button and the Minute which is indicated will go DOWN. (If you keep pressing it, the Minute will go DOWN continuously.)

Press the "MAINTE" button and the inner clock will be updated as 00 second, and then it goes to the "Date & Time Confirmation Set-up Menu".

※Minute set-up range: 00~59

5-5 Alarm Test

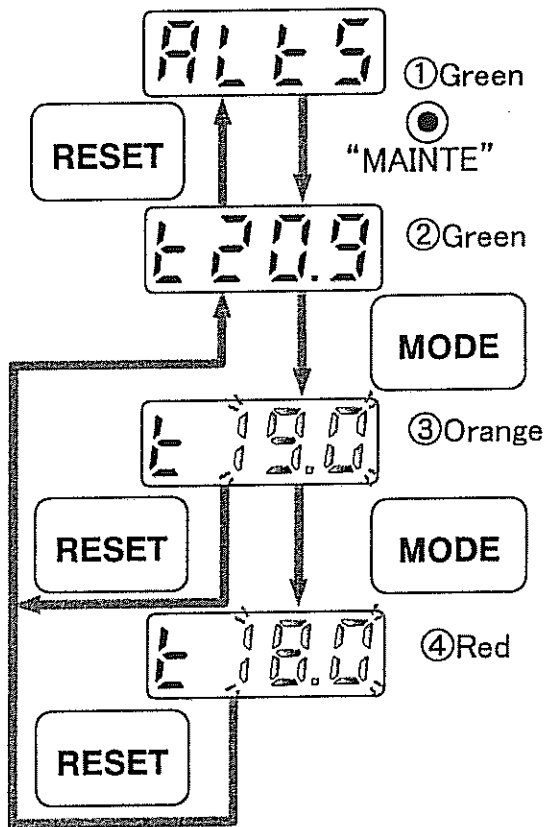

※"t" which is located in the left side of the test rate will be indicated in Green.

① <<Alarm Test Menu>>

Press the "MODE" button, it will return to the "Measuring Mode".

Press the "MAINT" button, it goes to the "Alarm Test 0" mode.

② <<Alarm Test 0>>

Test rate Air (20.9) will be displayed.

Press the "MODE" button, it goes to the "Alarm Test AL1" mode.

Press the "RESET" button, it will return to the "Alarm Test Menu".

③ <<Alarm Test AL1>>

Test rate AL1 will be displayed.

(AL1 rate flickers, AL1 LED flickers, buzzer 1 ON, AL1 relay ON)

Press the 「RESET」button, it goes to the alarm reset mode. (AL1 rate flashes, AL1 LED flashes, buzzer 1 OFF)

Press the "MODE" button, it goes to the "Alarm Test AL2" mode. (AL1 mode will be cleared.)

If you press the "RESET" button when alarm reset mode is on, it goes to the "Alarm Test 0" mode. (AL1 mode will be cleared.)

④ <<Alarm Test AL2>>

Test rate AL2 will be indicated.

(AL2 rate flashes, AL2 LED flashes, buzzer 2 ON, AL2 relay ON)

Press the "RESET" button, it goes to the alarm reset mode. (AL2 rate flashes, AL2 LED flashes, buzzer 2 OFF)

Press the "RESET" button while the alarm Reset mode is on, "Alarm Test 0" mode will start. (AL2 mode will be cleared.)

6. Connecting Wire

TD1

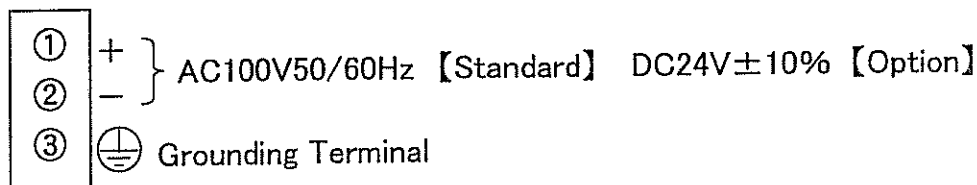

TD

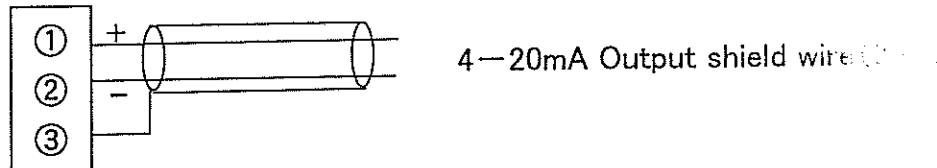

TD3

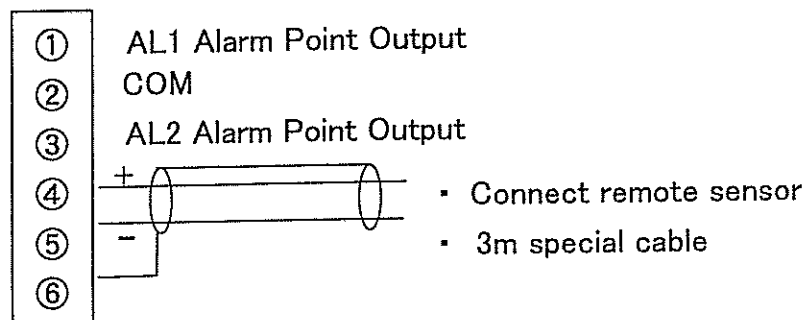

7. External Output Operation

7-1 External Output

4-20mA Output Specification

- (1)Signal Transmission System :Power Current Transmission (Non-insulation)
 (2)Transmission Channel :Shield Wire
 (3)Transmission Distance :Below 1km
 (4)Connecting Load Resistance :Below 300 Ω
 (5)Mode for Signal Level
- | | |
|---------------------|--|
| ①Detector Mode | : 4~20mA (Depend on gas concentration) |
| ②Gas Alarm | : 4~20mA (Depend on gas concentration) |
| ③Initial Clear | : 17.4mA (Fixed) |
| ④Maintenance Mode | : 17.4mA (Fixed) |
| ⑤Alarm Test | : 4~20mA (Depend on gas concentration) |
| ⑥Accident Alarm | : 0.5mA (Fixed) |
| (6)Power Source OFF | : 0mA |

7-2 4-20mA Output Chart

Status	Output mA	Remarks
Initial	17.4	Fixed rate
Normally (No alarms)	4.0~20.0	Depending on gas concentration
Scale Over	20.1~22.0	Depending on gas concentration
Trouble	0.5	Fixed rate
User Maintenance Mode Menu	4.0~22.0	Depending on gas concentration
Maintenance Mode Menu	17.4	Fixed rate
Air Adjustment	4.0~22.0	Depending on gas concentration
Alarm Point Confirmation	4.0~22.0	Depending on gas concentration
Alarm Summary Confirmation	4.0~22.0	Depending on gas concentration
Date & Time Confirmation*Set-up	4.0~22.0	Depending on gas concentration
Alarm Test	5.6~20.0	Depending on gas concentration

7-3 LED, Contact Point Output Chart

Status	1 st LED	2 nd LED	1 st Contact Point	2 nd Contact Point
Initial	Lights out	Lights out	OFF	OFF
Normally	Lights out	Lights out	OFF	OFF
1 st Alarm Time	Flickering (will be lighted after the reset)	Lights out	ON	OFF
2 nd Alarm Time	Flashing (will be lighted after the reset)	Flashing (will be lighted after the reset)	ON	ON
Trouble	Lights out	Lights out	OFF	OFF
User Maintenance Mode Menu	Lights out	Lights out	OFF	OFF
Air Adjustment	Lights out	Lights out	OFF	OFF
Alarm Point Confirmation	Lights out or flashing	Lights out or flashing	OFF	OFF
Alarm Summary Confirmation	Lights out or flashing	Lights out or flashing	OFF	OFF
Date & Time Confirmation*Set-up	Lights out	Lights out	OFF	OFF
Alarm Test	Lights out or flashing (will be lighted after the reset)	Lights out or flashing (will be lighted after the reset)	ON or OFF	ON or OFF

8. When Instrument is Not in a Good Condition

(1) Power source is not ON.

- Power source is not plugged in → Connect the power source code to the plug
- Power source switch is OFF → Turn on the power switch
- Fuse is cut off → Find out the cause of cut off, and exchange it with a new fuse. If you cannot find causes, ask our sales department.

(2) Indication is flashing

- Air adjustment has not been done → Air adjustment should be done.
Air adjustment is necessary when the power source is on or returning from the power failure.

(3) Alarm summary time does not fit → Date & time set-up should be taken

(4) 4~20mA output is differ from concentration rate → Make adjustment of 4mA, 20mA
(Contact the nearest agent)

(5) No buzzer sounds

- Buzzer is set off → Set the buzzer on (Contact the nearest agent)

(6) Contact point does not appear in the alarm test

- The zero point operation is set off in the alarm test. → Set on while you conduct alarm test. (Contact the nearest agent)

(7) Peak hold is not working when alarm beeps

- The peak hold is not set → Set peak hold mode. (Contact the nearest agent)

※If you still have any trouble after you have checked along with the instructions mentioned above, please ask the nearest agent.

9. Specifications

Model	OX-500
Detected Gas	Oxygen (O ₂)
Sampling Method	Diffusion sampling
Detection Principle	Galvanic cell
Sensor Model	OS-B11
Detected Range (1 digit)	0~25.0 vol % (0.1 vol %)
Display	3 digits 3 colors LED (Green, Orange, Red) Normal: Green
Types of Alarm	Gas alarm: 2 decrease alarms, latching mode (Non-latching with reset switch) Trouble alarm: Self reset
Preset Alarm Levels	1st: 19.0 vol %, 2nd: 18.0 vol %
Alarm Relays	Normally-open contact for both AL1/AL2, rated 125VAC to 1A (Resistive load)
Display of Alarm	Gas alarm 1: Flashing orange LED with gas display, flashing AL1 orange LED, intermittent buzzer Gas alarm 2: Flashing red LED with gas display, flashing AL2 red LED, continuous buzzer sound Trouble alarm: Flashing of red error message [E-**] (Displays error number at **), short intermittent buzzer sound
Alarm Track Record	10 cases The 10 latest cases of the highest concentration rate and date & time of occurrence after 1st alarm call.
Outputs	DC4-20mA Alarm call when trouble 0.5mA (resistance load below 300 Ω)
Alarm Contact Point	AL1/AL2 1a Common Contact point capacity AC125V 1A (resistance load)
Operating Temp. & Humidity	0~40°C(0~104°F), below 95%RH (Non-condensing)
Power Requirement	100VAC, 50/60Hz, Max 3.5VA, supplied with power cable (3m) or 24VDC, Max 2.0W
Dimensions & Weight	Approx. 95(W) × 135(H) × 35(D)mm Approx. 420g (DC24V spec. Approx. 220g)
Installation	Wall mounting type (By using accessory mounting plate or mount at one switch box) Cable inlet: Up, down and left/right, or rear side

10. Accessories

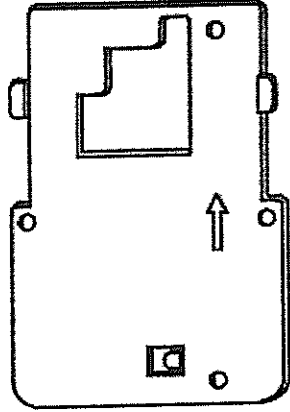

Connecting Panel (1 piece)
※It is connected to the body of the instrument.

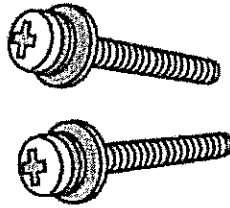

Pan head small screw (2 pieces)

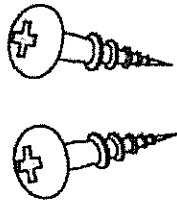

Small spike (2 pieces)