

RIKEN

PORTABLE COMBINATION GAS DETECTOR

MODEL R X - 5 1 6

R X - 5 1 7

OPERATION MANUAL

MARINE USE

Precaution in operation

- After reading this manual well, start to operate this instrument.
- Keep this manual where to carry out easily
- When take out this manual by use of construction work, be sure to put it where it was.
- Do not use this instrument for no other than given purpose.
- When operate this instrument without using this manual or repair it by use of no other parts than the genuine one, the safety and quality of products could not be guaranteed. When any accident should take place by those irregular method, we cannot assume the responsibility for it.

RKI Instruments, Inc. 33248 Central Ave. Union City, CA 94544
Phone: 800-754-5165 Fax: 510-441-5650

In the beginning

It is of our great pleasure to purchase Riken portable combination gas detector model RX-516/RX-517 this time. This instrument is an explosion-proof type portable gas detector which is designed to measure the presence of the following gas at crude oil tankers shown below.

RX-516

- Hydro carbon(HC) :0-100.0%LEL/2-100.0vol% (Iso-butane cal.)
- Oxygen(O₂) :0-25.0 vol%
- Hydrogen sulfide(H₂S) :0-100.0ppm

RX-517

- Hydro carbon(HC) :0-100.0%LEL/2-100.0vol% (Iso-butane cal.)
- Oxygen(O₂) :0-25.0 vol%
- Hydrogen sulfide(H₂S) :0-100.0ppm/0-1000ppm

This instruction manual is a guide book for operation to use and operate model RX-516/RX-517. It is kindly requested to read and understand this content by experienced users as well as beginners. The following headline shall be shown to carry out the safety and effective work in this instruction manual.

Danger

This means that it gives the serious harm to the human life, body or material directly such as touching high voltage.

Warning

This means that it gives the serious harm to the human body or material if do not perform the operation according to the instruction manual.

Caution

This means that it gives the slight harm to the human body or material if do not perform the operation according to the instruction manual.

* Note

This means the advice in the operation.

C O N T E N T S

1 . Caution in operation	3
2 . Name of each part	4
3 . Operation	8
3 - 1 . Check item before operation	8
3 - 2 . Preparation	8
3 - 3 . Start-up and end-up	9
3 - 4 . Flow monitor check	1 0
3 - 5 . Zero point adjustment	1 0
3 - 6 . Operational procedure	1 2
3 - 7 . Peak value mode	1 3
3 - 8 . Power pump ON/OFF	1 3
3 - 9 . Operation finished	1 4
3 - 10. Practical application	1 5
4 . Alarm	1 6
4 - 1 . Alarm display	1 6
4 - 2 . Alarm buzzer & lamp	1 6
4 - 3 . Trouble display	1 7
5 . Each function	1 9
5 - 1 . Operation mode control	1 9
5 - 1 - 1 . Alarm setting	2 0
5 - 1 - 2 . Date/time setting	2 1
5 - 2 . LCD back light	2 1
5 - 3 . Data logger	2 2
6 . Maintenance check	2 3
6 - 1 . Battery replacement	2 3
6 - 2 . Gas calibration (Span adjustment)	2 4
6 - 3 . Filter replacement	2 7
6 - 4 . Sensor replacement	2 7
6 - 5 . Daily check and regular check	2 7
6 - 6 . The replacement of parts	2 8
6 - 7 . Storage or treatment not to use for a long period)	2 9
7 . Scrap of products	2 9
8 . Trouble shooting	3 0
9 . Definition of words	3 1
1 0 . Specifications	3 2
1 1 . Detection principle	3 3
1 1 - 1 . NDIR method (Non-Dispersive Infrared)	3 3
1 1 - 2 . GALVANIC CELL method	3 3
1 1 - 3 . ELECTRO-CHEMICAL CELL method	3 4
RIKEN STANDARD WARRANTY	3 5

1 . Caution in operation

To maintain the function for safety, follow the following instruction.



Warning

- Do not modify nor change the circuit and structure etc. When modify or change, it could not maintain the function.
- This is explosion-proof product. Battery has to be replaced in non-hazardous zone. The battery replacement in hazardous zone shall be out of the scope for explosion-proof product.
- This is explosion proof. Be sure to operate with carrying case on.
- Do not measure in the environment of oxidant gas presence. When measure, it may shorten the sensor life.
- When measure under organic solvent gas presence, do it in short time and make sensor cleaning by sucking fresh air after measurement.



Caution

- Do not drop or damage it. This is a fire instrument. When strong shock is given, the function may be the case not to maintain. Especially, when power is on, the shock from outside is easy to receive. So, the caution at this point is needed.
- Keep it from the direct splash of water. As this is not of drip-proof, it may cause the trouble by splash of water.
- Do not give the electric noise such as by walkie-talkie during operation. When receive the electric noise, it may cause the trouble of reading and instrument.
- When the atmospheric pressure and temperature are changed, it may affect the gas reading.
- When it is condensed, the normal operation is impossible.
- Be sure to mount the internal filter and filter tube.

2 . Name of each part



POWER / ENTER SW

This is used for power ON/OFF and entering the figure.

PUMP / - SW

This is used when make the pump ON/OFF and deverse the figure.

ZERO / + SW

This is used when make zero adjustment and increase the figure.

PEAK SW

This is used when to let the peak displayed.

MODE / ESC SW

This is used when enter the set mode or cancel the input.

ALARM LAMP

When trouble alarm triggers, this shall blink and light out.

LCD with Back-light

This shows the gas reading.

H2S gas range mode cock (for model RX-517 only)

The mode for H2S Low H2S High can be changed over by this switch.

《Display of RX-516 / 517》

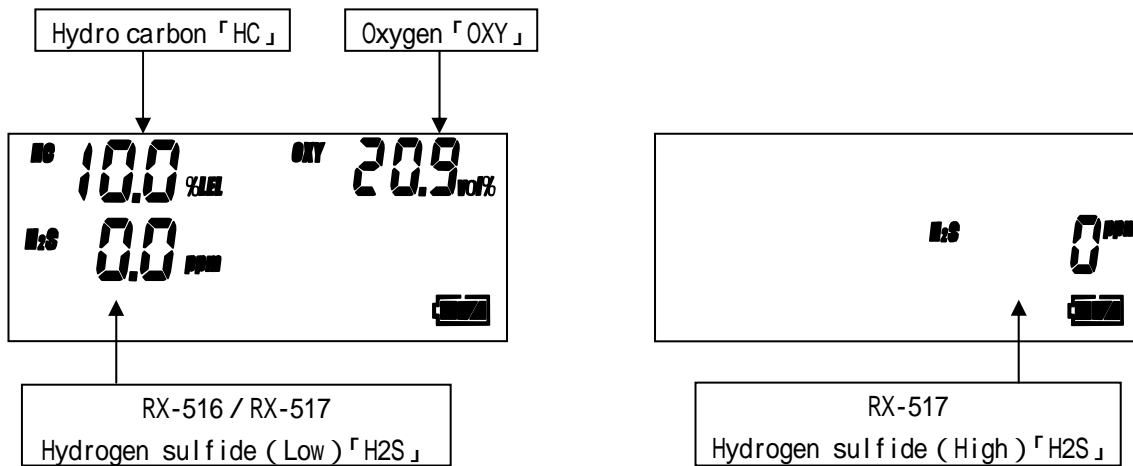

***Caution**

- For HC, when it goes over 100%LEL, it shall be changed to vol% automatically.

《RX-517 case》

- H2S can be changed over by H2S gas range mode cock. (H2S High H2S Low)

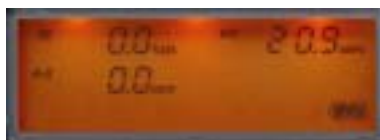

H2S low display

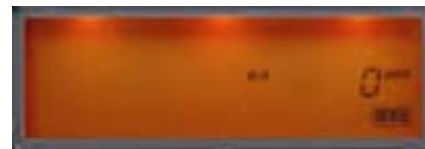

H2S high display

【Standard accessories】



Carrying case with shoulder strap



Filter tube with flow monitor and junction tube



Gas sampling probe



Gas sampling hose



Alkaline battery

【Optional accessories】



Gas sampling hose 30m with plummet



Gas sampling hose 30m with float type sampling head



Gas sampling bag 1L for LEL and VOL and calibration gas cylinder



Gas sampling bag 1L for LEL and VOL and calibration gas cylinder



Absorbent cotton



Water proof filter for filter tube (10pcs.)



Metal storage box



H2S calibration checker (for H2S)



Data logging software



Communication cable

3 . Operation

3 - 1 . Check item before operation

RX-516 or 517 instrument :

- Check that there is no damage for display unit etc.

Filter tube with flow monitor :

- Check the dirt of inside cotton filter. When it gets dirt, replace the cotton filter with new one.
- When water drops remain, wipe it out and change it with new one.
- Check that these is no crack or damage.
- Check that these is no loose mount on the nipple.

Gas sampling hose :

- Check that there is no crack, creek or twist on the instrument.

3 - 2 . Preparation

- (1) Dry batteries are put into instrument.
- (2) Put carrying case on to instrument.
- (3) Connect the instrument(Gas inlet) + Filter tube with flow monitor + Sampling hose respectively.



For gas sampling, 3 kinds tip formation are available and change it according to he measuring environment.

Standard: Sampling hose (1m) and gas sampling probe

Optional: Sampling hose (30m) with plummet

Sampling hose with floating gas sampling head (30m)

- Connection with sampling hose

Take knurling part by fingers and pull arrow mark to " " direction. Put it to the arrow mark direction. Then, release the finger from the knurling part. Further press and sound "tick," and then, locked.

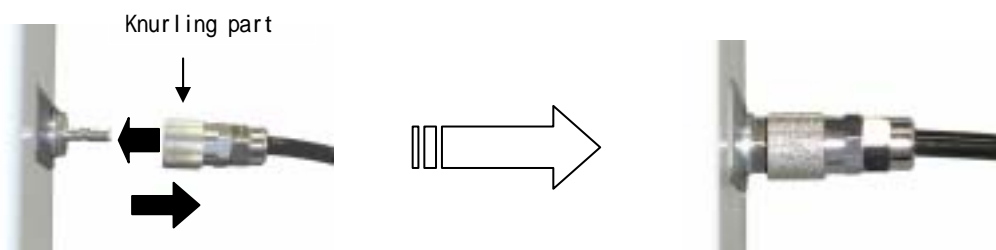

3 - 3 . Start-up and end-up

When press power switch for 3 sec, the power gets on and this shall start up sequencing the program of the voltage check, filter connection check and sensor connection check respectively.

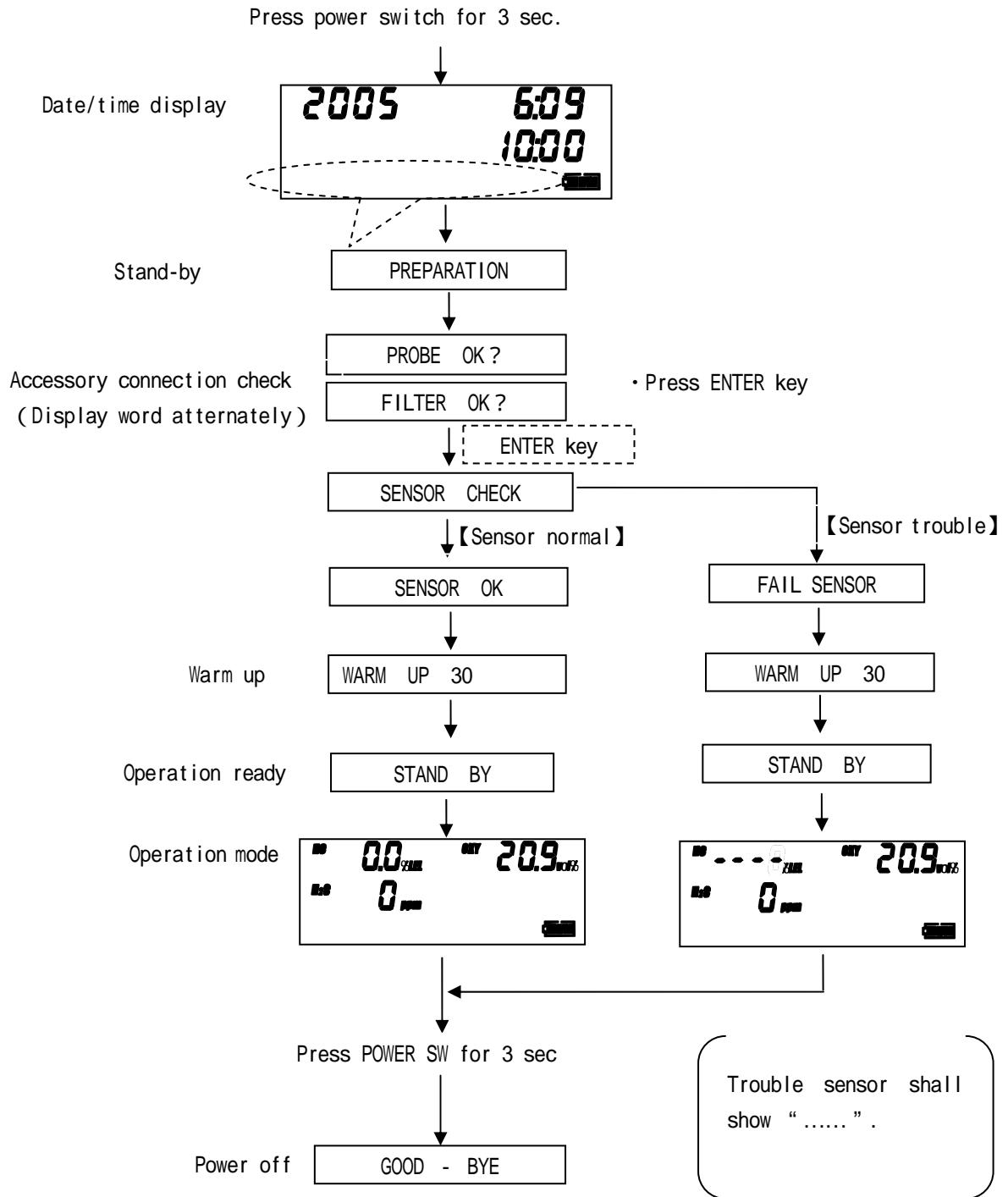

3 - 4 . Flow monitor check

When the power gets ON, the pump shall start operation check that suction works properly by filter tube with flow monitor.

Float

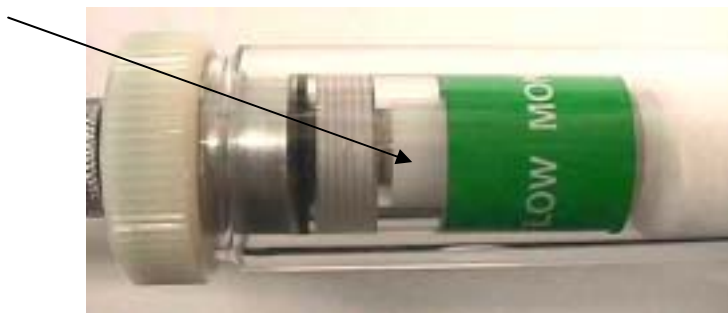

At normal sucking (Can see float)



Not sucking (Can not see float)

3 - 5 . Zero point adjustment

Zero point calibration for this instrument shall be done HC, O₂(Oxygen), H₂S(Hydrogen sulfide).

Caution

When make zero adjustment , proceed to do it after having fresh air sucked into instrument for over 1 min. When make zero adjustment through the suction of gas present atmosphere, the correct measurement can not be done and it may lead to the accident.

< FLOW CHART OF ZERO POINT ADJ >

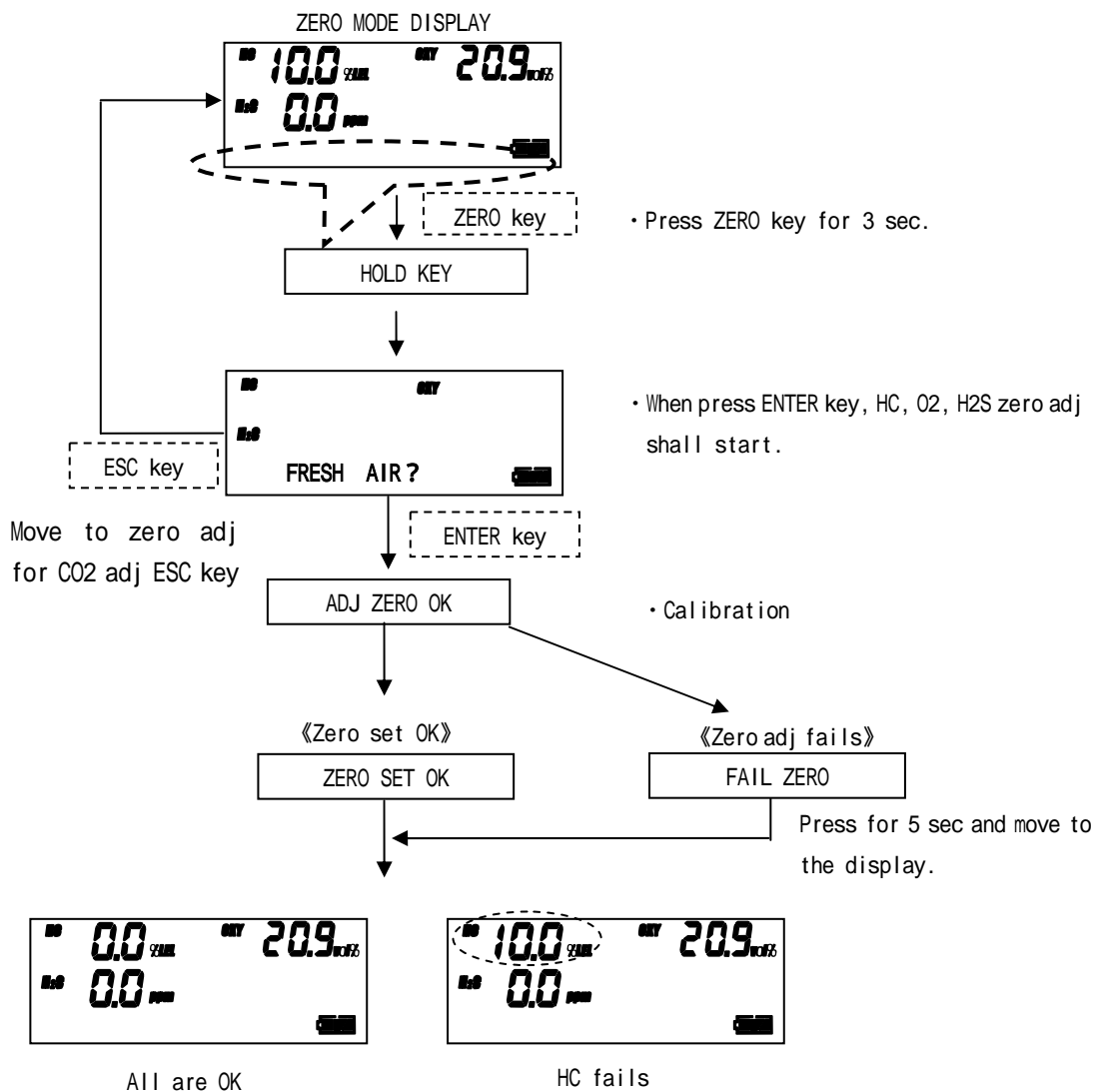

***Note**

- To cancel previous operation, press ESC key.
 But can not cancel after press ENTER key.

《RX-517 case》

- For zero adjustment of H₂S high, proceed to make zero adjustment by changing to the display of H₂S high

3 - 6 . Operational procedure

Approach the sampling hose to the sampling site for measurement and leave sampling gas sucked.

- Take care that any twist on the sampling hose can not be made.
- Stop sampling hose at the point of measurement.
- From the hose length consider the delay time and read out the reading after the reading gets stable.

Danger

- Oxygen depletion air etc may be exhausted from gas outlet. Do not breathe in there absolutely.
- High density gas over (LEL) may be exhausted. Do not approach fire there absolutely.

Warning

- In the place where environment temp is remarkably changed, there may be the case that accurate oxygen measurement is impossible by temperature change. Wait until the instrument may be used to the ambient temp (About 10 min) and start measurement after having made zero calibration again.
- Do not use for after purpose then the measurement of combustible gas, vapor and toxic gas mixtures.

Caution

- When suck air containing gas, do it after removing water vapours.
- When suck high temp gas, do it after being used to be ambient temp.
- Do not have water and oil sucked wrongly, the internal pump and sensor may be troubled.
- When measure, check the roaring sound of pump and flow monitor.
It is impossible to measure at pump work stop.
- Do not block the pump outlet, the reading shall show a little higher.
- When measure oxygen in inert gas for a long time, be sure to measure lower than 15% CO₂ by all means. When exceed higher density than 15%, shorten the time for this measurement as life of oxygen sensor may be shortend.

***Note**

When measure the high density gas than LEL, the hung-up phenomenon.

When measure HC by vol%, do measure it as it is.

When make zero adjustment, remove the sampling base and supply fresh air sucked into instrument.

When measure by %LEL, make air cleaning of sampling hose and start to measure after reading goes down to zero.

3 - 7 . Peak SW value mode

When press PEAK SW during operation, the peak valve from power on to the current point (HC, H2S = MAX, O2=MIN) shall be shown.

【RX-516 / 517】

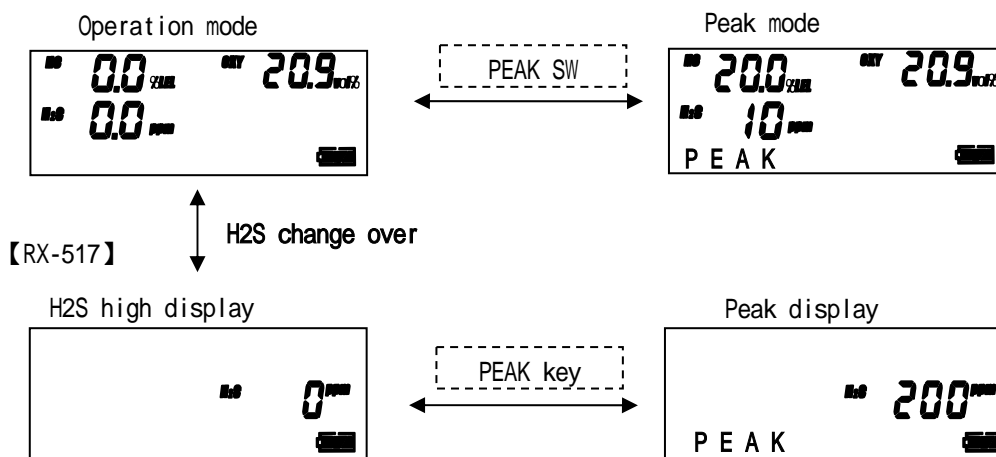
***Note**

《RX-517 case》

- In the H2S high display, the peak value of H2S is displayed.
- When changed from peak display, it changes to the operation display.

When hold and press ESC key for 3 sec during the peak value display, the peak value shall be cleared.

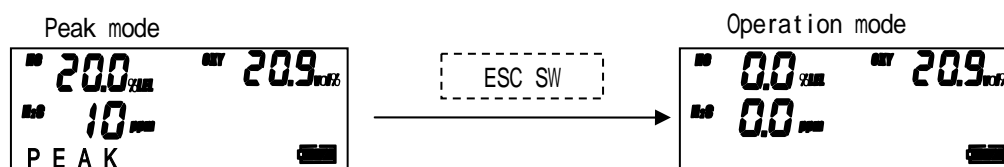
***注記**

《RX-517 case》

All peak value is cleared on both the displays of HC, O2, H2S low and the another one of H2S high.

3 - 8 . Power pump ON/OFF

When move the sampling point and stop to operate temporarily, the pump only stops operation. When stop the pump operation, the power consumption shall be reduced by about 40%. Then the other than pump is on active and once the pump re-starts up, this shall start operation immediately.

***Note**

- When do not operate for the time being, make off the power. Other than pump is active and if it is left alone, the battery is consumed up.

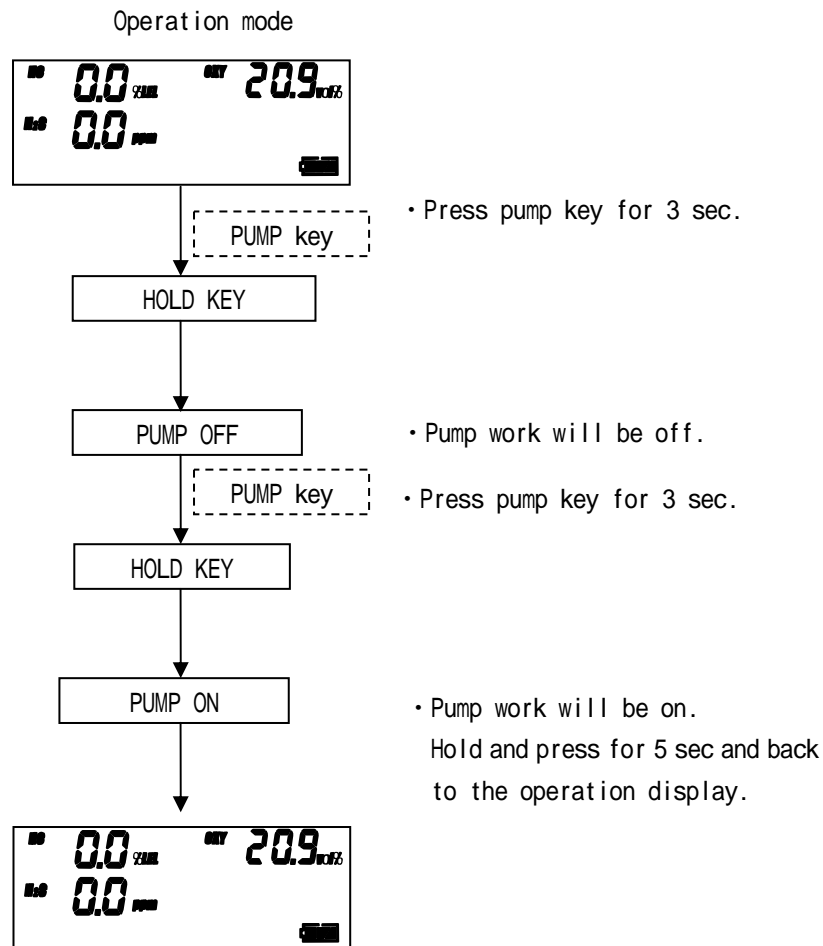

3 - 9 . Operation finished

(1) Treatment after operation

Wind up sampling hose so treat it can not be twisted and bent.

Supply fresh air in the condition of sampling hose connected and make air-cleaning until the reading gets to zero nearly.

When use the floating gas sampling head or 30m sampling hose (30m: optical acc.), be sure to make air-cleaning for 5 minutes before use.

(2) Power OFF

When hold and press power SW for about 5 sec, the buzzer sounds 8 times and the power will be off.

Caution

Never fail to make air cleaning of sampling hose.

When the vapors, water drop and substance remain, there will be the possibility of remaining material at start-up. This will be the cause for trouble.

3 - 1 0 . Practical application

(1) Tank inside of crude oil tanker

By use of sampling hose with plummet, it is available to monitor the gas density in the tank.

《Sample in crude oil tanker》

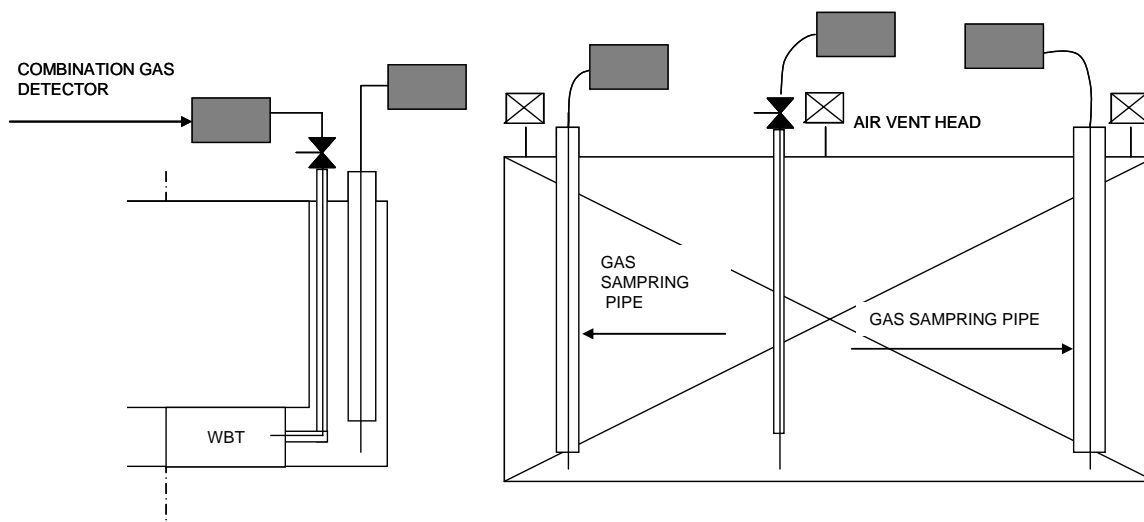

⚠ Caution

When measure O₂ in insert gas for a long time, be sure to use CO₂ in the atmosphere of below 15%. When use higher density than 15%, make the measuring time as short as possible.

《Use of sampling hose with plummet》

Mount the sampling hose to the instrument.

Put into the tank from the plummet of hose.

Sampling hose shows the mark at every 5m and stop it at the point desired to stop by checking the distance.

Check that the flow monitor works normally.

When the reading gets stable after 3 minutes have passed, read out the value.

When change the sampling point, stop at the sampling point and in the same manner, read out the reading after over 3 minutes have passed.

《HC read out》

HC in the measuring gas stands for iso-butane. But the crude oil to be measured is a mixtures. It is not always to correspond to the gas density. Here, by exerpting the crude oil vapor to be considered, when read out the value representing normal hexane, it will be nearly value in reality. In case of normal hexane, from the vapor condition, this gas can not be vaporiged to high density range (vol%). Then the HC gas in this description should be iso-butane gas.

《H₂S high density》

High density H₂S may effect other sensors for trouble. So, in the atmosphere of high density H₂S to be generated, RX-517 is recommended.

《Interference measures in inert gas》

In the component of inert gas, a lot of interference gas may be present. When it should be present so much to affect the measurement, it shall be required to mount the interference removal filter.

4 . Alarm

4 - 1 . Alarm display

At 1st alarm, the figure will blink and “Warring” will blink.
 At 2nd alarm, the figure will blink and “Alarm” will blink.
 At over alarm, the figure will blink and “Over” will blink.

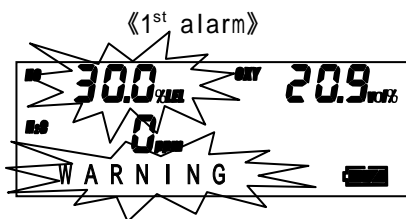

Alarm 1st alarm set (HC, H₂S)
 Alarm 1st alarm set (O₂)
 【WARNING display, Intermittent LED, Blink】

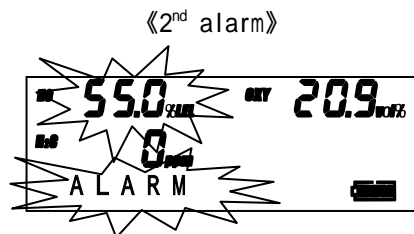

Alarm 2nd alarm set
 【ALARM display, Intermittent LED, ON】

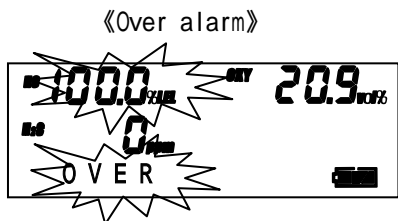

Alarm F.S.
 【OVER display, Intermittent LED, ON】

Non latched mode after alarm

4 - 2 . Alarm buzzer & lamp action

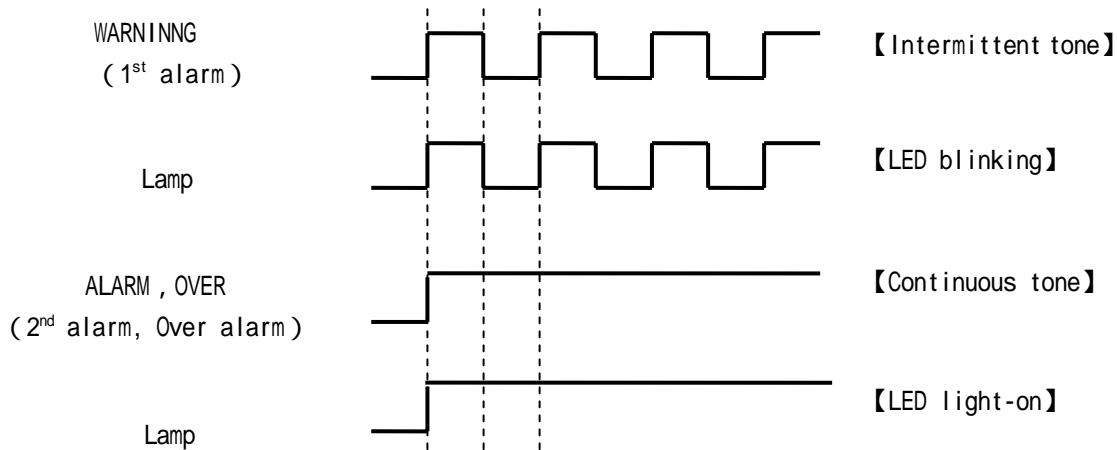

4 - 3 . Trouble display

(1) Low flow alarm

- When low flow trouble triggers, “LOW FLOW” is displayed and pump stops working.
- Buzzer sounds continuously.
- After checking the cause, reset low flow alarm by “ESC” key. The pump will re-start and return to the operation display.

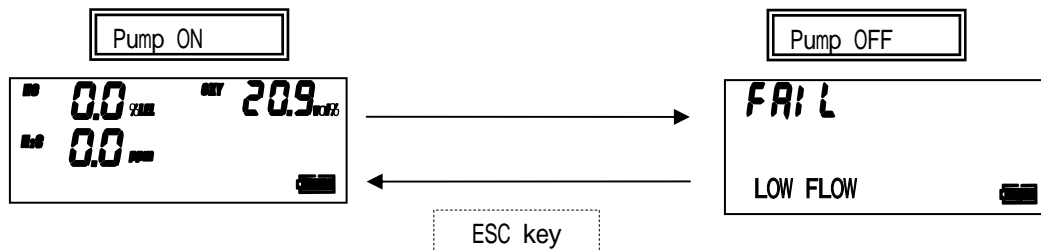

⚠ Caution

When low float trouble took place, be sure to check the cause to make low flow. Especially when suck water, it will be the cause for trouble. After checking the condition of probe filter tube, re-start the pump by ESC key. (When press ESC and re-start in the water remaining condition, there will be the case of water intrusion into instrument. For low flow trouble, it shall be cautioned that no error display will be the setting mode.

(2) Low battery alarm

- When the power of battery is dropped, “REPLACE BATT.” Will be displayed.
- Buzzer will sound continuously.
- After displaying “REPLACE BATT.”, it does not accept other than “Power OFF”.
- After power off, replace the battery with new one. (See it for 6-1. Battery replacement).

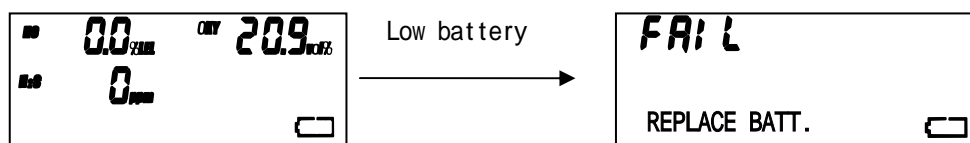

POWER OFF operation available only by POWER key.

(3) System trouble alarm

- When the program is troubled, “SYSTEM FAIL” will be shown.
- Buzzer will sound continuously.
- After “SYSTEM FAIL” is shown, it does not accept other than “Power off”.

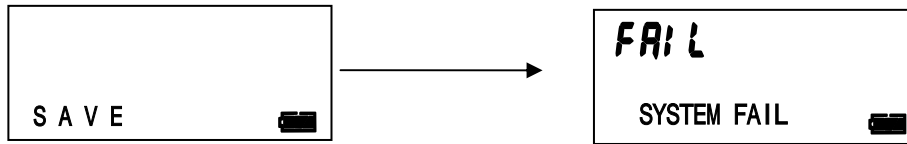

Power off available only by power SW

(4) Sensor trouble alarm

- When sensor is troubled, “FAIL SENSOR” is displayed and the measuring gas for the troubled will be shown.
- (Sensor for trouble detected at start-up time shall be shown.)
- Buzzer will sound continuously.
- After showing “FAIL SENSOR”, it does not accept other than “Power off”.

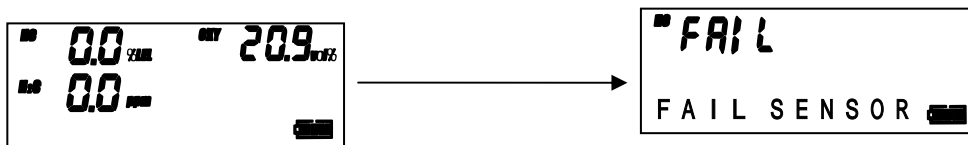

POWER off available only by power SW

***Caution**

When try to measure offer gas than the troubled, make power off once and re-start it.
After checking the start-up and error, move to the other sensor than the troubled.



5 . Each function

5 - 1 . Operation mode control

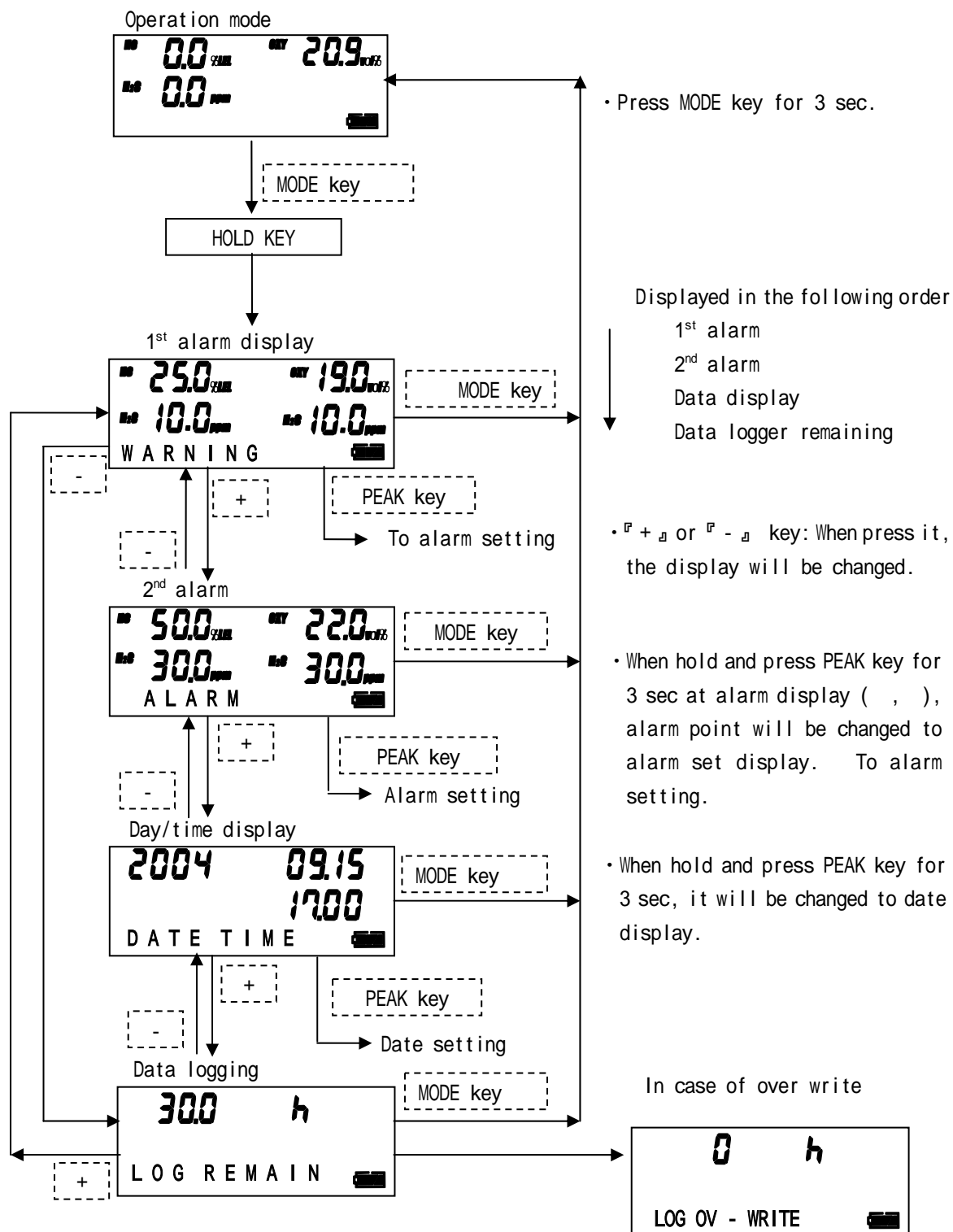

*Note

《RX-517》

- In the display of alarm, H2S high is displayed simultaneously.
- From both display of H2S low and H2S high, it is available to go into mode.

5 - 1 - 1 . Alarm setting

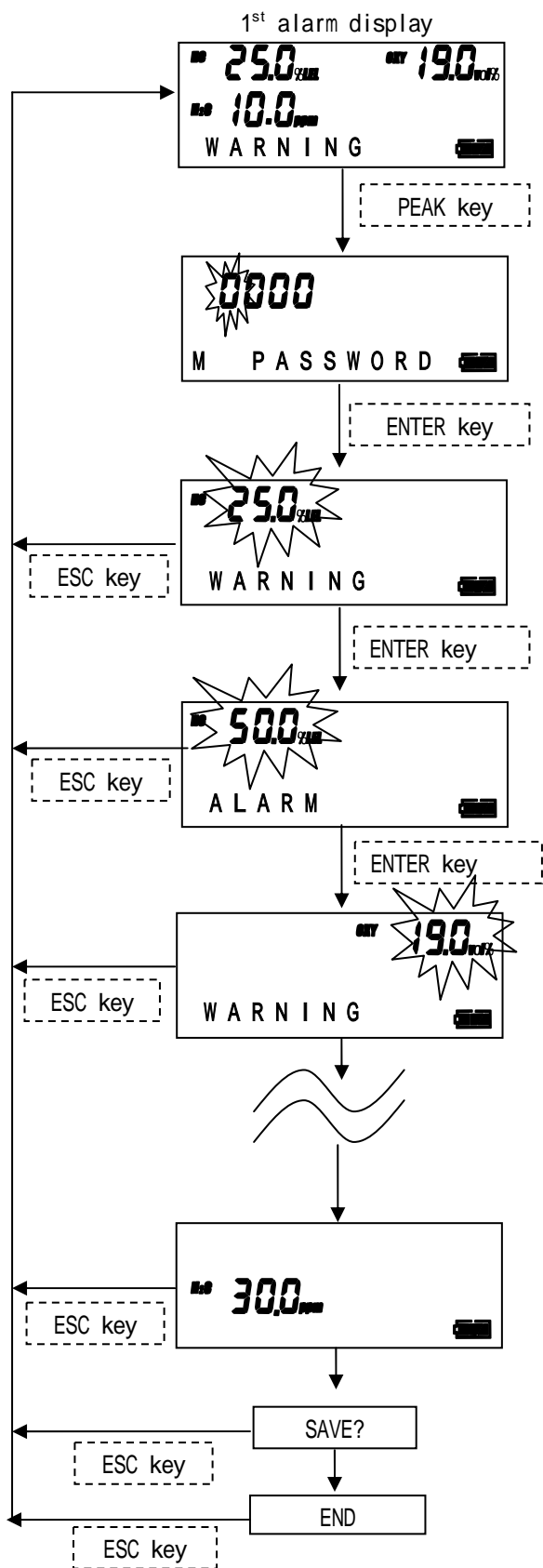

- Input the password 【3002】 .
- When press ↑ or ↓ , the number will be changed.
- Fix the number by ENTER key and move to next digit.
- After fixing the last digit, move to alarm setting (When make the password error, it will show “ERROR” . Press ESC key.)
- First, 1st alarm point shall be shown on the display.
- Change ↑ or ↓ key and confirm it by pressing ENTER key.
- When press ESC key, the setting shall be void and first alarm point shall be shown.
- Then 2nd alarm point of CH4 shall be shown on the display.
- When change by ↑ or ↓ key, confirm it by ENTER key.
- When press the setting by ESC key, go back to 1st alarm point.

- HC : 1st alarm point
- HC : 2nd alarm point
- OXY : 1st alarm point
- OXY : 2nd alarm point
- H₂S : 1st alarm point
- H₂S : 2nd alarm point
- High H₂S : 1st alarm point (RX-517)
- High H₂S : 2nd alarm point (RX-517)

Adjust it in this procedure.

- After finishing 2nd alarm of H₂S is adjusted, it displayed “SAVE ?” .
- When press “ENTER” key, save the set value and shall show “END” display and go back to 1st alarm point display.
- When press “ESC” key, the set value is canceled and go back to 1st alarm point display.

5 - 1 - 2 . Date/time setting

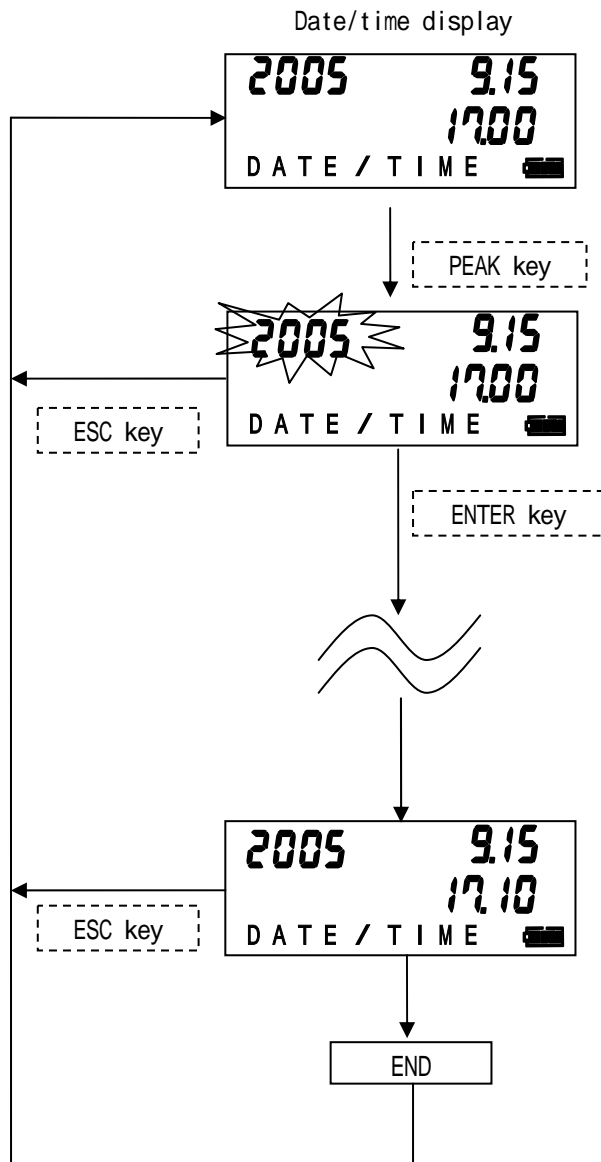

- First, set the year.
- The set number shall blink.
- The change of number is set by 『 + 』 or 『 - 』 key.
- Press ENTER key and the number is entered.
- When press “ESC” key, the set work stops in the way and go back to the date /time display.

Year
 Month
 Day
 Hour
 Minute

Set each in this turn.

- After finish the minute, press “ENTER” key. “END” display is shown and go back to date/time display.

5 - 2 . LCD back light

LCD back light will be on in the following

- Initial clear : Light on
- Operation on : Light on for 30 sec from operation.
 By key operation, it will light on.
 After light on, when do not operation for over 30 sec, it will light out.
- Alarm on : Light on
- Trouble on : Light on

5 - 3 . Data logger

Data logger function has following 5 kinds.

(1) Interval trend

The change of measuring gas shall be recorded until the power on into off. Recording time can 100 times data. When it is over 100 times, the old data shall be deleted and record the new data by up-dating.

But when exceed the max recording time within 100 times, the old data shall be deleted.

The max record time for interval time shall be as follows.

Interval time	10 sec	30 sec	1 min	3 min	5 min	10 min
Max record time	10 H	30 H	60 H	180 H	300 H	600 H

Standard interval time shall be 30 sec.

The interval time can be adjusted by “Data Management Program (Option)” .

(2) Alarm trend

This record the alarm trigger and the change of measuring valve for 30 minutes (Total: 1 hour) to fro and back of alarm triggering point.

Alarm trend shows the peak value of 5 sec every 5 sec.

The recording number shall keep the record of data for up-dating 8 pcs data.

When exceed 8 pcs data, the old data is deleted and shall record the latest data.

(3) Alarm event

It is recorded as event that alarm triggers.

Alarm trigger time and measuring gas and kind of alarm (AL1, AL2, OVER) shall be recorded.

The record number will save the max 100 pcs data from the latest event.

When exceed 100 pcs data, the oldest data shall be deleted and the latest data shall be recorded.

(4) Trouble event

It is recorded as event that trouble triggers. Trouble trigger time, measuring gas, instrument information and trouble event shall be recorded.

This can record 100 pcs data Max from the past by counting from the latest.

When exceeds 100 pcs data, the oldest data is deleted and updated to the latest data.

(5) Calibration history

When calibrated, this cal data is recorded.

The cal hour, density around cal and calibration error shall be recorded.

Past 20 times data by counting from the latest cal history can be saved.

When exceed 2 times, the latest data shall be recorded by deleting the oldest.

The recorded data can be read out from option “Data management program” .

***Note**

This data logger function is based on over-light method (By deleting the oldest data, the latest data shall be recorded.

6 . Maintenance check

For this correct operation, follow to the following procedure.

As this is safety instrument. Be sure to make the regular maintenance. If any trouble should take place, contact RIKEN KEIKI or nearest agent.

6 - 1 . Battery replacement

Warning

- For battery replacement, make it non-hazardous area by all means after turning off the power.
- Be sure to change the battery with the genuine ones.

When replace the batteries, replace all four pcs with new ones.

Check that the power is off. But when the power is on, make off the power first by use of POWER/ENTER key.



Remove the carrying case from the unit.

Open the battery cover on the bottom of unit by turning the screw with (-) screwdriver or coin etc counter-clockwise.

Remove 4 pcs batteries and put on new batteries by taking care of battery polarity.
Close the battery cover.

Caution

- Be sure to close the battery cover.

***Note**

- When remove the battery, remove it from (+). When put on, do it from (-) polarity.

6 - 2 . Gas calibration (Span adjustment)

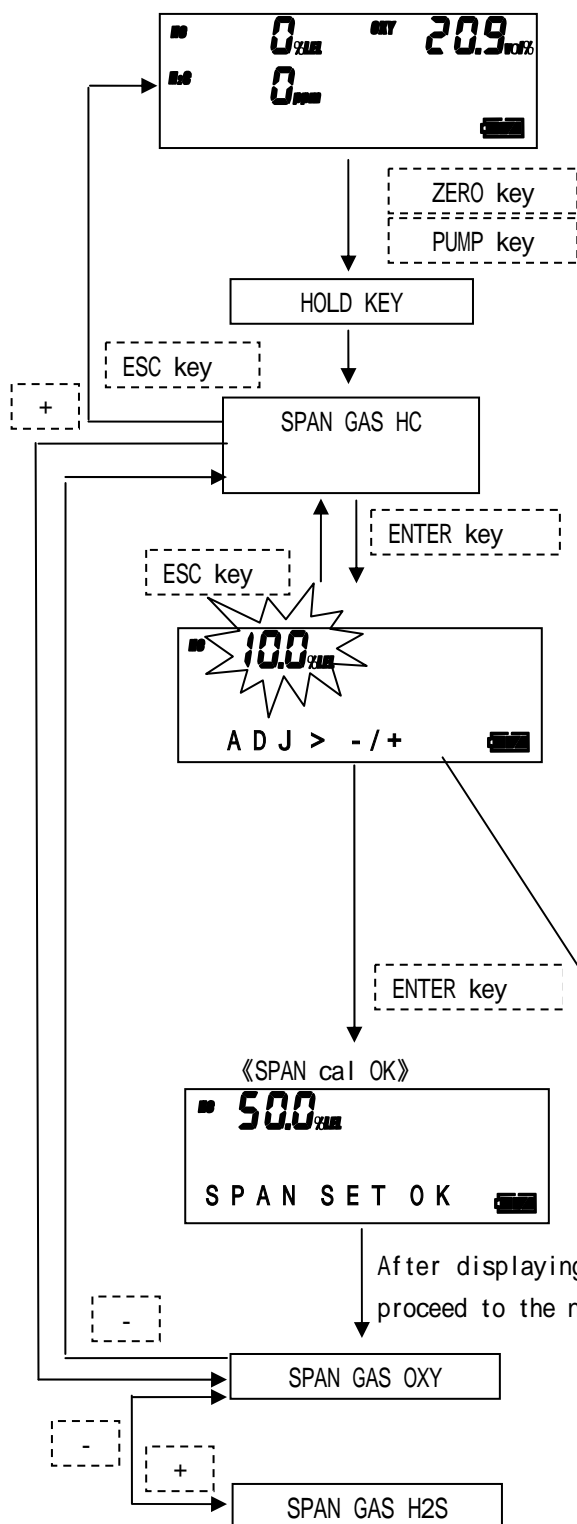

- Hold and pressing ZERO and PUMP key simultaneously in the operation mode.
- First, CH4 display shall be shown.
- When press ENTER key, “HC” gas calibration shall start.
- When press 「+」 key, it shall change to gas calibration of 「OXY」 「H2S」.
- When pressing ESC key, it shall return to “Operation display”.
- This shall display gas name, gas density and unit. (When press ESC key, it shall return to HC display.)
- Gas density shall blink.
- Have cal gas sucked into instrument and unit the reading gets stable.
- When the gas density differs, adjust to cal gas value by 「+」 or 「-」 key.
- After adjusted to it, fax the span by pressing ENTER key.
- After span adjusted, proceed to the oxygen display.
- For gas calibration of O2 and H2S make the same operation.
- After completion calibration, go back to the operation display by pressing “ESC key”.

***Note**

《RX-517》

- For measurement of H2S high, the mode display shall be changed from “H2S high” to “cal display”.
- When mode switch is ON during the cal mode the cal mode shall be cancelled and changed to operation mode.

⚠ Danger

- Compressed cylinder gas is used for gas calibration and take care at handling.
- At calibration by combustible gas, do not approach it to the fire.
- Exhaust the remaining gas in the sampling gas appropriately.

⚠ Caution

Before gas calibration, be sure to make zero adjustment.

《Handling of sampling bag and canned gas》

Sample the cal gas into sampling bag from canned gas.

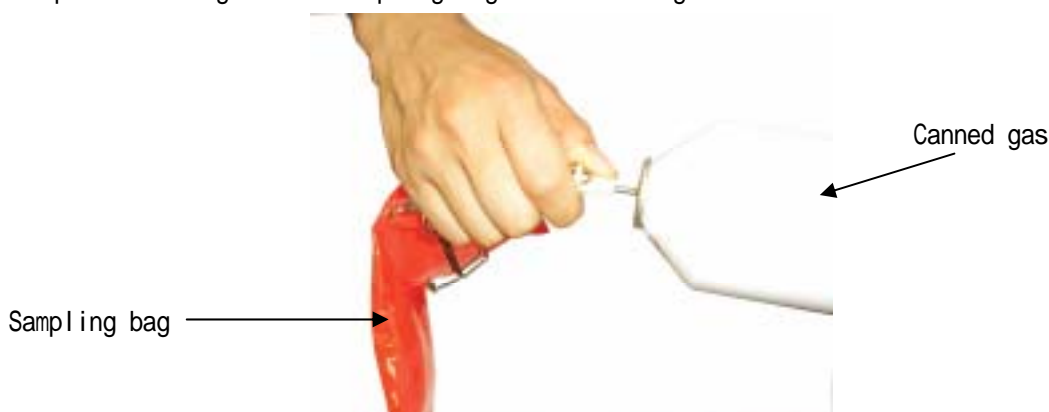

Sampling bag with cal gas in shall be used by putting to gas in side at gas calibration.



⚠ Danger

Do not make gas calibration by use of lighter gas. By the ingredient in the lighter gas, the sensor function may deteriorate.

⚠ Caution

- Do not supply the calibration gas by plugging in the inlet of canned gas directly. It may lead to the internal damage of instrument.

《Cal gas make-up by H2S gas checker CK-82》

Take out 1 pce. ampoule from accessory ampoule pack.
 Check that the rubber caps are fixed in the cover of container.
 Open the cover of container and deflate the air by squeezing the pressure adj bag.
 Put up the ampoule crusher knob and put the ampoule into ampoule crusher inside of the cover shown below. When the ampoule is put in reversely, the ampoule may be crushed.

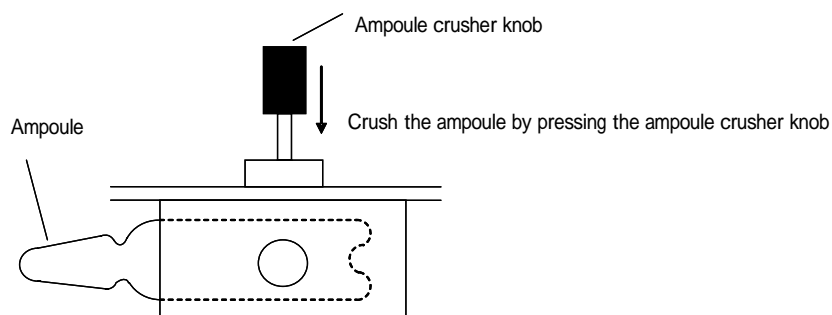

After the ampoule is put in, close the cover.
 Check that the rubber caps are put on the top cover.
 After checking that the cover is closed, put in the ampoule crusher knob and crush the inside ampoule.
 Grip the container with hands and shake it to up & down left & right slightly so that H2S can not remain in the ampoule crushed.
 About 21 ppm H2S is supposed to be produced in the container.

**Caution**

- 21ppm H2S gas density by CK-82 is the theoretical value in the calculation. Actually, the error of 1-2ppm could be expected. When desired to check H2S in the container, check it by detector tube. When use gas checker CK-82, see the separate manual for model CK-82 together.

6 - 3 . Filter replacement

For filter (cotton) inside of filter with flow monitor, check it before use and when it gets dirty, replace it.

- (1) Turn the knurling part in depth for filter tube with flow monitor and open the inside.
- (2) Remove the cotton of it by tweezers etc.
- (3) Put the cotton filter uniformly on even base inside of filter tube and return back the filter tube in reverse procedure.

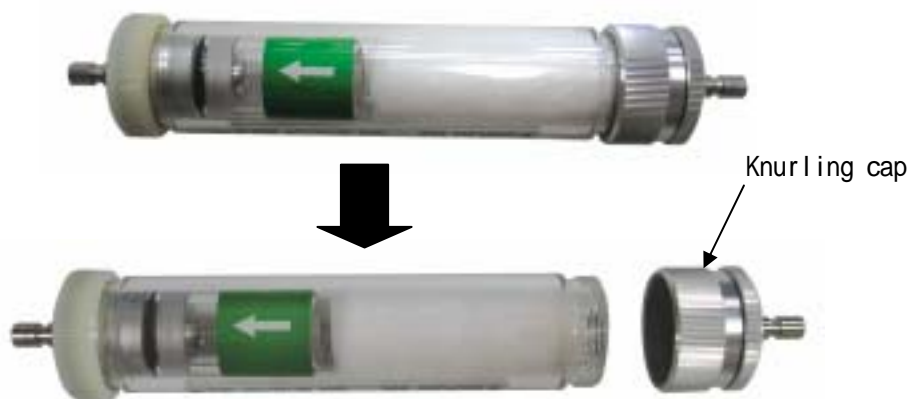

⚠ Caution

- Do not put cotton filter too much inside.
- When suction flow is too much, it will be difficult to monitor accurately.

***Note**

- The cotton filter replacement should be make once in a month.

6 - 4 . Sensor replacement

When the following phenomenon took place, it will be the life end of sensor.

- (1) It can not calibrate.
- (2) Reading can not go back if make air calibration.
- (3) The reading is unstable.

When the sensor replacement is needed, contact RIKEN KEIKI or nearest agent.

6 - 5 . Daily check and regular check

(1) Daily

- Is there any damage for switches, lamps, display and panel ?
- Pump suction performance check (Does the pump moving sound correctly ? Can any abnormal sound be heard ?)
- Performance check of flow monitor (Check that the position of flow is correct at pump “ ON ” and “ OFF ” .
- Battery voltage check

(2) Regular maintenance check

The regular maintenance is recommended to receive from the qualified service agent once in a year.

6 - 6 . The replacement of parts

The following parts have a life and each, regular replacement shall be recommended.
When replace, contact RIKEN KEIKI or nearest agent.

《Recommended consumable parts list for replacement》

No.	Name	Check frequency	Replacement frequency (Year)
1	Sensor pack	6 months	1
2	Internal filter	6 months	1
3	Pump	6 months	1
4	Interference removal filter	12 months	1
5	Hydrophobic filter (Filter tube with flow monitor internal parts, accessories)	3 months	0.5
6	Cotton (Filter tube with flow monitor internal parts, accessories)	3 months	0.5
7	Packing (Filter tube with flow monitor internal parts, accessories)	6 months	1
8	Flow monitor Filter tube with flow-monitor internal parts, accessories)	6 months	1
9	Memory back-up battery	-	5~6

***Note**

- About replacement frequency is a hint and it may differ by the frequency in use.
They do not show the warranty period.
- In the case of high frequency in use, it may be shorter than the above mentioned frequency in use.

6 - 7 . Storage or treatment not to use for a long period

The instrument shall be kept in the following condition.

Temp : 10 ~ 30

Humidity : 30 ~ 80%RH

Environment : Place free from gas and solvent vapours.

Store the instrument in the box kept in originally.

When the storage box was lost, store it in vinyl pack etc.

7 . Scrap of products

When dispose the waste, follow the regional law etc locally and do it in the same category with the industrial waste through the appropriate procedure any harmful materials are not used except oxygen sensor and H₂S sensor.

For O₂ sensor and H₂S sensor waste, contact RIKEN KEIKI or nearest agent.

8 .Trouble shooting

This trouble shooting does not mention all the trouble causes. The following is mentioned briefly by picking up the point to help survey of trouble cause in high frequency.

Phenomenon	Cause	Treatment
SYSTEM FAIL	• Excess noise effects etc.	• Re-start up and check status. Request to manufacture.
FAIL SENSOR	• Sensor trouble	• Check connect status and contact manufacture.
	• Did excess shock etc by dropping, crushing.	• Check connect status and contact manufacture.
FAIL FLOW	• Water, oil are soaked.	• Check whether any damage, suction marks of water, oil etc shall be found on sampling hose and filter with flow monitor.
	• Filling by filter dust.	• Replace the filter with new.
	• Substance is clogged.	• Remove substance.
LOW BATTERY (REPLACE BATT.)	• Low battery of dry battery.	• Make power off and replace battery in non-hazardous area. (See "6-1.BATT. REPLACEMENT".)
ZERO CAL FAIL (FAIL ZERO)	• Fresh air is not sucked normally.	• Make zero adjustment again by having fresh air sucked into instrument.(See 3-5.ZERO ADJUSTMENT)
	• Sensor trouble.	• Make sensor replacement.
SPAN CAL FAIL (FAIL SPAN)	• Cal gas is not supplied correctly	• Make gas calibration again by supplying cal gas.(See "6-2. GAS CALIBRATION".)
	• Sensor trouble.	• Make sensor replacement.
Power can not be ON	• No power on.	• Put battery correctly.
	• Battery is exhausted.	• Replace batteries.
	• Polarity is wrong.	• Correct battery polarity.
	• Pressing POWER SW is too short.	• Hold and press POWER SW for 3 sec.
Pump is working Power can not be ON	• All the batteries are put in reversely.	• Put batteries correctly according to battery replacement (See "6-1. BATTERY REPLACEMENT".)
Pump does not work	• Pump life ends or troubled.	• Request manufacture to repair.
	• Not measured and pump stop working.	• Re-start pump operation. Press PUMP SW until LCD will display "PUMP ON".
	• Pump connection fails.	• Check connection condition and contact RIKEN KEIKI for repair.
Gas is not sucked	• Filter or hose etc are removed or clogged.	• Check connection status of filter, hose and filth or twist and use in correct condition.
Zero blinks	• Zero is below minus.	• Check that gas is free around and make zero adjustment. • For CO ₂ , make it after mounting CO ₂ scrubber.
"100.0 vol%" blinks (HC only)	• Zero and span are deviated and it shall be the output of 100 vol%	• Repeat again the procedure of zero adjustment and gas calibration.

9 . Definition of words

Vol%

Gas density is expressed by the unit of a part.

ppm

Gas density is expressed by the unit of a part per.

10,000ppm = 1vol%

%LEL

Suppose to put the Lower Explosive Limit as 100 and at that time, combustible gas density is expressed by the unit of a part per hundred.

Iso-butane : 100%LEL = 1.8vol%

N-hexane : 100%LEL = 1.2vol%

Calibration

By use of calibration gas etc, it is to adjust the reading, display value or set value to the true valued.

PEAK value

MAX or MIN value in a period.

ALARM preset value

This is an alarm preset point value to give alarm when it comes to this alarm point.

Maintenance check

This is a work to maintain the required function and condition to perform.

Data logging

Every internal of period, the function to save memory of gas density at alarm is provided.

Hung-up phenomenon

After suck the high density gas and introduce fresh air into instrument, the phenomenon to show higher reading by effect of residual gas for a while.

Oxygen deficiency

According to the decrease of oxygen, it is a phenomenon to make trouble for humans.

10 . Specifications

Refer to the specifications for separate catalog overleaf.

Model	RX-516 (HC/O ₂ /H ₂ S 0-100.0ppm) , RX-517 (HC/O ₂ /H ₂ S 0-100.0ppm & 0-1000ppm)			
Gas detected	Iso-butane (HC)	Oxygen (O ₂)	Hydrogen sulfide (H ₂ S)	
Detection principle	NDIR(Non-Dispersive infrared)	Galvanic cell	Electro-chemical cell	
Detection range (digit)	0-100%LEL (0.5%LEL) 2-100vol% (0.5vol%)	0-25.0vol% (0.1vol%)	<LOW> 0-100.0ppm (0.5ppm)	<HIGH> 0-1,000ppm (1ppm)
Operating Temp. & Humidity	-10 ~ +50 , below 90%RH (non-condensing)			
Safety rating	ExiadiIBT3X (Alkaline batteries "Size C" only) , KIMM approved, MED approved			
Power source	Alkaline batteries (Size C) 4pcs			
Continuous operation	Approx. 30 hours (no alarm or light, at 25)			
Display	Digital LCD (with back light)			
Alarm types	Gas alarm : StandardOFF (Optional1 st and 2 nd user adjustable, self-resetting) Trouble alarms (Self diagnosis) : Sensor disconnection, low battery, circuit trouble And calibration error			
Dimension & Weight	Approx. 200(W) x 80(H) x 142(D)mm Approx. 1.8kg (including batteries)			Approx. 2.0kg (including batteries)
Special functions	Peak hold, Datalogging High concentration hydrogen sulfide range with manual switch (RX-517)			
Standard accessories	Carrying case with shoulder strap, Filter tube with flow monitor and junction tube, Gas sampling hose, Gas sampling probe, Alkaline batteries (4pcs), Instruction manual			

1 1 . Detection principle

1 1 - 1 . NDIR method (Non-Dispersive Infrared)

The model is based on NDIR method (Non-Dispersive Infrared) and this structure is shown below.

The infrared beam emitted from the light source passes through the measuring cell, and optical band pass filter which can pass the absorption wave of measuring gas and attains to the infrared sensor. The amount of infrared attaining to the infrared sensor through the measuring cell and will decrease according to its density.

The variable amount of infrared is measured by the infrared sensor and it is displayed as gas concentration.

Then, there is no sensitivity against CO etc which have the different absorption wave from the measuring gas. Then there is no sensitivity against N₂ and H₂ etc which cannot absorb infrared. As compared with the conventional catalytic combustion method, there is no poisoning material to be absorbed and almost no sensitivity drop on this detection principle.

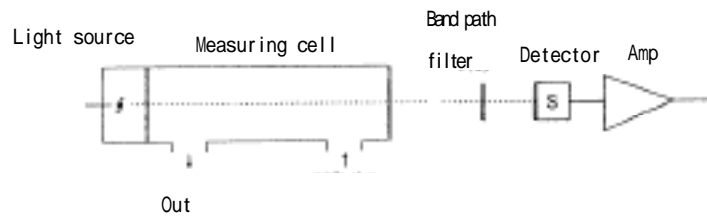

1 1 - 2 . GALVANIC CELL method

Galvanic cell is consisting of a lead anode and a gold cathode in electrolyte covered by a membrane. When oxygen enters into the gold cathode, a current which is directly proportional to the oxygen concentration will be produced, and amplified current will produce a reading on a meter in percent oxygen.

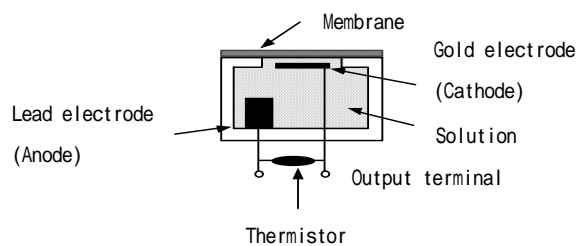

Figure

1 1 - 3 . ELECTRO-CHEMICAL CELL method

This gas detector applies an electrochemical sensor. The sample gas is electrolyzed by the electrolyzed cell added with specific electric potential (bias voltage) and detected from the electrolyzed current generated at that time.

The electrochemical sensor is designed to keep the interface between electrode and electrolyte at a constant potential (Bias voltage) and is the method to electrolyze gas directly. Then as the gas has the bias voltage generating its own electrolyzation (Redox reaction) the bias voltage of sensor is determined by the redox potential.

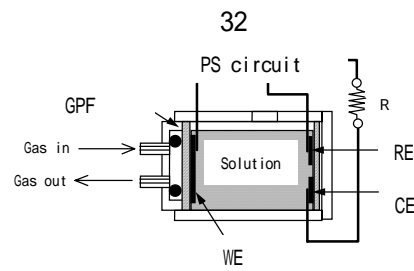

Figure

RIKEN STANDARD WARRANTY

RIKEN KEIKI CO., LTD. warrants gas alarm equipment manufactured and sold by us to be free from defects in materials and workmanship for a period of one year from date of shipment from RIKEN KEIKI CO., LTD. Any parts found defective within that period will be repaired or replaced, at our option, free of charge, F.O.B. factory.

This warranty does not apply to those items which by their nature are subject to deterioration or consumption in normal service, and which must be cleaned, repaired or replaced on a routine basis.

The alarm contact output specified in this system is provide for the use of buzzer and lamp to be communicated to the other external place than the system installed.

But to secure the safety, there may be the case that the following interlocking performance shall be made by use of alarm contact output from customers.

1. Stop the gas supply.
2. Stop the action of system which uses gas.
3. Let the cervices exhaust fan operated.
4. Let stop the work of the staffs in the area by the auto paging system and escaped to the outside from there
5. Let the alarm transmitted to a remote place by auto communication system.
6. Let the alarm transmitted by the lamp and buzzer to this area and that area.
7. Others.

But, we do not assume the responsibility for the secondary damage, which may be generated by this interlocking action because it is not in our scope of recognition.

Then, we cannot strike the sales contract or the manufacture in the scope to reimburse this secondary damage.

Warranty is voided by abuse including rough handling, mechanical damage, operation, alteration, or repair procedures not in accordance with instruction manual.

This warranty indicates the full extent of our liability, and we are not responsible for removal or replacement cost, local repair costs, transportation cost, or contingent expenses

incurred without our prior approval.

This warranty covers instruments and parts sold (to users) only by authorized distributors dealers and representatives as appointed RIKEN KEIKI CO., LTD.

We do not assume the indemnification for any accident or damage caused by the operation of this gas monitor and our warranty is limited to the replacement of parts or our complete goods.