



INSTRUMENTS

Model GX-2003

Operator's Manual

Part Number: 71-0089RK

Revision: D

Released: 3/26/07

www.rkiinstruments.com

Warranty

RKI Instruments, Inc., warrants the Model GX-2003 sold by us to be free from defects in materials, workmanship, and performance for a period of two years from the date of shipment from RKI Instruments, Inc. This includes the instrument and the original sensors.

Replacement parts are warranted for 1 year from the date of their shipment from RKI Instruments, Inc. Any parts found defective within their warranty period will be repaired or replaced, at our option, free of charge. This warranty does not apply to those items which by their nature are subject to deterioration or consumption in normal service, and which must be cleaned, repaired, or replaced on a routine basis. Examples of such items are:

Absorbent cartridges

Filter elements, disks, or sheets

Pump diaphragms and valves

Warranty is voided by abuse including mechanical damage, alteration, rough handling, or repair procedures not in accordance with the instruction manual. This warranty indicates the full extent of our liability, and we are not responsible for removal or replacement costs, local repair costs, transportation costs, or contingent expenses incurred without our prior approval.

THIS WARRANTY IS EXPRESSLY IN LIEU OF ANY AND ALL OTHER WARRANTIES AND REPRESENTATIONS, EXPRESSED OR IMPLIED, AND ALL OTHER OBLIGATIONS OR LIABILITIES ON THE PART OF RKI INSTRUMENTS, INC., INCLUDING BUT NOT LIMITED TO THE WARRANTY OF MERCHANTABILITY OR FITNESS FOR A PARTICULAR PURPOSE. IN NO EVENT SHALL RKI INSTRUMENTS, INC., BE LIABLE FOR INDIRECT, INCIDENTAL, OR CONSEQUENTIAL LOSS OR DAMAGE OF ANY KIND CONNECTED WITH THE USE OF ITS PRODUCTS OR FAILURE OF ITS PRODUCTS TO FUNCTION OR OPERATE PROPERLY.

This warranty covers instruments and parts sold to users only by authorized distributors, dealers, and representatives as appointed by RKI Instruments, Inc.

We do not assume indemnification for any accident or damage caused by the operation of this gas monitor and our warranty is limited to replacement of parts or our complete goods.

Table of Contents

Chapter 1: Introduction	7
Overview	7
About the GX-2003	7
Specifications	9
About This Manual	10
Chapter 2: Description	11
Overview	11
Instrument Description	11
<i>Case</i>	12
<i>Sensors</i>	13
<i>LCD</i>	14
<i>Control Buttons</i>	14
<i>Printed Circuit Boards</i>	14
<i>Alarm LED Arrays</i>	15
<i>Infrared Communications Port</i>	15
<i>Buzzers</i>	15
<i>Vibrator</i>	15
<i>Batteries</i>	15
<i>Pump</i>	16
<i>Flow Chamber</i>	16
<i>Inlet Filter Holder</i>	17
Standard Accessories	18
<i>Tapered Rubber Nozzle</i>	18
<i>Protective Rubber Boot</i>	18
<i>Sample Hose & 10 Inch Probe</i>	19
<i>Bar Hole Probe</i>	19
Chapter 3: Using the GX-203 in Normal Mode	20
Overview	20
Start Up, Normal Mode	20
<i>Turning On the GX-2003, Normal Mode Only</i>	20
<i>Turning On the GX-2003 in Normal With All Modes Active</i>	23
<i>Performing a Demand Zero, Normal Mode</i>	24
<i>Turning Off the GX-2003, Normal Mode</i>	25

Measuring Mode, Normal Operation	25
<i>Monitoring an Area</i>	25
<i>Combustible Gas Detection</i>	26
Measuring Mode, Alarms	27
<i>Alarm Indications</i>	28
<i>Resetting and Silencing Alarms</i>	29
<i>Responding to Alarms</i>	30
Display Mode	31
<i>HC Range Screen</i>	32
<i>ID Screen</i>	33
<i>Peak Screen</i>	34
<i>Elapsed Time Screen</i>	34
<i>TWA/STEL Screen</i>	34
<i>Date/Time/Battery Charge Screen</i>	35
<i>Clear Data Logger Screens</i>	35
<i>Remaining Log Time Screen</i>	36
Datalogging	37
Data Cal 2000	37
Calibration Mode	38
<i>Calibration Supplies and Equipment</i>	38
<i>Preparing for Calibration</i>	39
<i>Calibrating the GX-2003</i>	39
<i>Adjusting the LCD Contrast</i>	44
Chapter 4: Using the GX-2003 in Bar Hole Mode	45
Overview	45
Start Up, Bar Hole Mode	45
<i>Turning On the GX-2003, Bar Hole Mode</i>	45
<i>Performing a Demand Zero, Bar Hole Mode</i>	48
Bar Hole Testing	49
<i>Performing a Bar Hole Test</i>	49
<i>Turning Off the GX-2003, Bar Hole Mode</i>	51
Chapter 5: Using the GX-2003 in Leak Check Mode	52
Overview	52
Start Up, Leak Check Mode	52
<i>Turning On the GX-2003, Leak Check Mode</i>	52
<i>Performing a Demand Zero, Leak Check Mode</i>	55

Leak Testing	56
<i>Locating a Leak</i>	56
<i>Turning the Buzzer On and Off in Leak Check Mode.</i>	56
<i>Turning Off the GX-2003, Leak Check Mode</i>	56
Chapter 6: Setup Mode	58
Overview	58
Tips for Using Setup Mode	59
Using Setup Mode.	59
<i>Updating the Alarm Point Settings</i>	60
<i>Updating the Lunch Break Setting</i>	61
<i>Updating the Alarm Latching Setting</i>	62
<i>Updating the Alarm Silence Setting.</i>	62
<i>Updating the Confirmation Beep Setting</i>	63
<i>Updating the Interval Time Setting</i>	63
<i>Updating the Log Data Over Write Setting</i>	63
<i>Updating the Date and Time Settings</i>	64
<i>Updating the Calibration Interval.</i>	64
<i>Updating the Calibration Time Remaining Setting</i>	65
<i>Updating the Calibration Expired Action Setting</i>	65
<i>Updating the LCD Contrast Setting.</i>	66
<i>Updating the GX-2003's Serial Number.</i>	66
<i>Turning the User ID Function On or Off.</i>	67
<i>Calibrating Using Auto Calibration.</i>	67
<i>Calibrating Using Single Calibration.</i>	69
<i>Updating the LCD Backlight Time Setting.</i>	71
<i>Turning the Password Function On or Off.</i>	71
<i>Turning LB Mode Display On or Off.</i>	72
<i>Setting the Bar Hole Measurement Time</i>	72
<i>Exiting Setup Mode.</i>	73
Chapter 7: Maintenance	74
Overview	74
Troubleshooting.	74
Replacing or Recharging the Batteries	76
<i>Replacing Alkaline Batteries or Ni-MH Battery Pack</i>	76
<i>Recharging the Battery Pack in the Instrument</i>	77
<i>Recharging the Battery Pack Out of the Instrument.</i>	78

Replacing the HC and CO Filters	79
Replacing a Sensor	80
Replacing the Hydrophobic Disk Filter, Cotton Filter, and Wire Mesh Disk	82
Parts List	84
Appendix A: Calibrating with a Sample Bag	86
Overview	86
Calibration Supplies & Equipment.	86
Preparing for Calibration.	87
Calibrating the GX-2003.	88
<i>Calibrating with the Auto Calibration Method.</i>	<i>89</i>
<i>Calibrating with the Single Calibration method</i>	<i>91</i>
Parts List	93

WARNING: Understand manual before operating. Substitution of components may impair intrinsic safety. To prevent ignition of a hazardous atmosphere, batteries must only be changed or charged in an area known to be nonhazardous. Not tested in oxygen enriched atmospheres (above 21%).

Chapter 1: Introduction

Overview

This chapter briefly describes the GX-2003. This chapter also describes the *GX-2003 Operator's Manual* (this document). Table 1 at the end of this chapter lists the specifications for the GX-2003.

About the GX-2003

Using an advanced detection system consisting of up to five gas sensors, the GX-2003 sample draw gas monitor detects the presence of combustible gas, oxygen (O₂), carbon monoxide (CO), and hydrogen sulfide (H₂S) simultaneously. The GX-2003's compact size and easy-to-use design makes it ideally suited for a wide range of applications, including sewage treatment plants, utility manholes, tunnels, hazardous waste sites, power stations, petrochemical refineries, mines, paper mills, drilling rigs, and fire fighting stations. The GX-2003 offers a full range of features, including:

- Simultaneous four-gas monitoring of combustible gases, O₂, CO, and H₂S (in Normal Mode)
- Choice of three operating modes: Normal Mode for typical confined space or area monitoring; Bar Hole Mode for checking of bar holes when searching for underground gas leaks; and Leak Check Mode for locating leaks in valves and piping.
- Sample-drawing pump with up to 40-foot range.
- Liquid crystal display (LCD) for complete and understandable information at a glance
- Distinctive audible/vibrating alarms for dangerous gas conditions and audible alarms for unit malfunction
- Microprocessor control for reliability, ease of use, and advanced capabilities
- Alarm trend data (when used in Normal Mode)
- Data logging functions (when used in Normal Mode)
- STEL/TWA (when used in Normal Mode) and over range alarm display



- Peak hold and average readouts (when used in Normal Mode)
- Built-in time function
- RF shielded high impact plastic case
- CSA classified for Class I, Division I, Groups A, B, C, and D hazardous atmospheres

WARNING: The Model GX-2003 detects oxygen deficiency, elevated levels of oxygen, combustible gases, carbon monoxide, and hydrogen sulfide, all of which can be dangerous or life threatening. When using the Model GX-2003, you must follow the instructions and warnings in this manual to assure proper and safe operation of the unit and to minimize the risk of personal injury.

NOTE: ONLY THE COMBUSTIBLE GAS DETECTION PORTION OF THIS INSTRUMENT HAS BEEN ASSESSED FOR PERFORMANCE.

Specifications

Table 1: GX-2003 Specifications

Target Gas	%LEL Combustible Gas (Methane Calibration Standard)	% Volume Combustible Gas (Methane Calibration Standard)	Oxygen (O ₂)	Hydrogen Sulfide (H ₂ S)	Carbon Monoxide (CO)
Range (Increment)	0-100% LEL (1% LEL)	0 - 100% vol (1% vol)	0-40.0% vol (0.1 vol%)	0-100 ppm (0.5 ppm)	0-500 ppm (1 ppm)
Auxiliary Range (Increment)	0-5,000 ppm (100 ppm) In Leak Check Mode Only	n/a	n/a	n/a	n/a
Sampling Method	Sample Draw				
Response Time	T90 Within 30 Seconds				
Display	Dot Matrix LCD Display				
Gas Alarms (Factory Settings)	<p><u>Alarm 1</u> 10% LEL</p> <p><u>Alarm 2</u> 50% LEL</p>	None	<p><u>Alarm 1</u> 19.5 vol% (Decreasing)</p> <p><u>Alarm 2</u> 23.5 vol% (Increasing)</p>	<p><u>Alarm 1</u> 10 ppm</p> <p><u>Alarm 2</u> 30 ppm</p> <p><u>TWA</u> 10 ppm</p> <p><u>STEL</u> 15 ppm</p>	<p><u>Alarm 1</u> 25 ppm</p> <p><u>Alarm 2</u> 50 ppm</p> <p><u>TWA</u> 25 ppm</p> <p><u>STEL</u> 200 ppm</p>
Operating Temperature & Humidity	-20°C to 50°C/Below 85% RH (Without Condensation)				
Safety/Regulatory	<p style="text-align: center;">  C  US 186718 CSA classified, "C/US", as Intrinsically Safe. Exia. Class I, Groups A, B, C, & D. Temperature Code T3C. </p>				
Power Supply	<ul style="list-style-type: none"> • Three AA size alkaline batteries standard • Ni-MH Battery Pack (3.6 VDC Nominal) optional, Direct Charging 				

Continuous Operating Hours @ 25 °C	<ul style="list-style-type: none"> Alkaline Batteries: 14 Hours (Non Alarm Operation, Fully Charged) Ni-MH Battery Pack: 16 Hours (Non alarm Operation, Fully Charged)
Case	High-impact Plastic, RF Shielded, Dust and Weather Proof
Standard Accessories	<ul style="list-style-type: none"> 10 foot hose 10 inch probe Flexible 4 inch tapered rubber nozzle Protective rubber boot
Optional Accessories	<ul style="list-style-type: none"> 115 VAC Charging Station 12 VDC Charging Station Data Logging Software IrDA/Serial or IrDA/USB Cable for Downloading Data to a Computer With Data Logging Software (not needed if computer has an infrared port) Communication Software (Windows® 98, 2000, & XP) Automatic Calibration Station & Software Bar Hole Probe
Dimensions and Weight	<p>Approximately 171(H) x 65(W) x 39(D) mm (5.6"H x 2.5"W x 1.5"D)</p> <p>Approximately 310 g (11 oz.)</p>

About this Manual

The *GX-2003 Operator's Manual* uses the following conventions for notes, cautions, and warnings.

NOTE: Describes additional or critical information.

CAUTION: *Describes potential damage to equipment.*

WARNING: *Describes potential danger that can result in injury or death.*

Chapter 2: Description

Overview

This chapter describes the GX-2003 instrument and accessories.

Instrument Description

The instrument includes the case, sensors, LCD, control buttons, printed circuit boards, alarm LED's, infrared communication port, buzzers, vibrator, batteries, pump, flow chamber, and inlet filter holder.

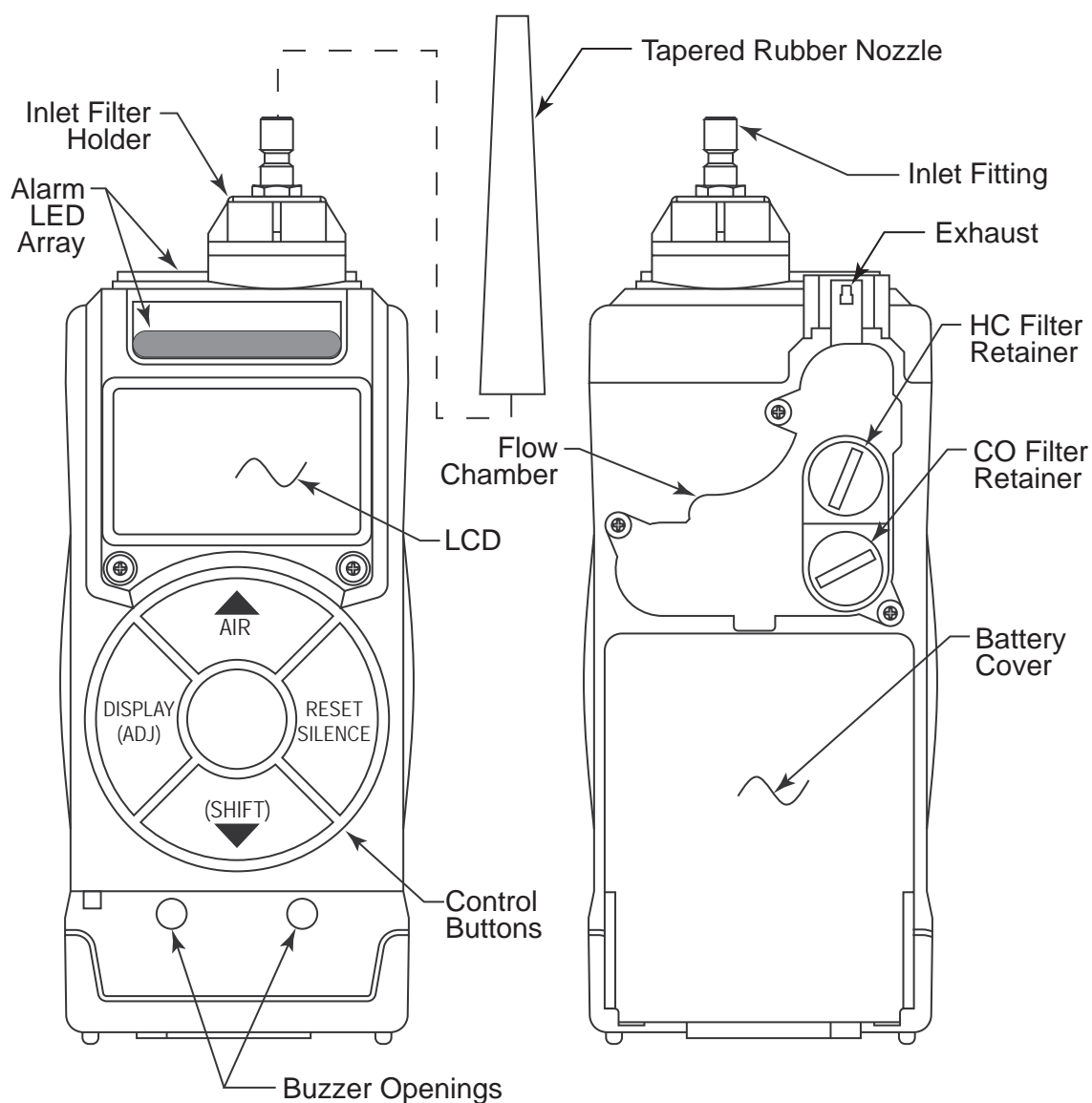

Figure 1: Components of the GX-2003, Front & Back

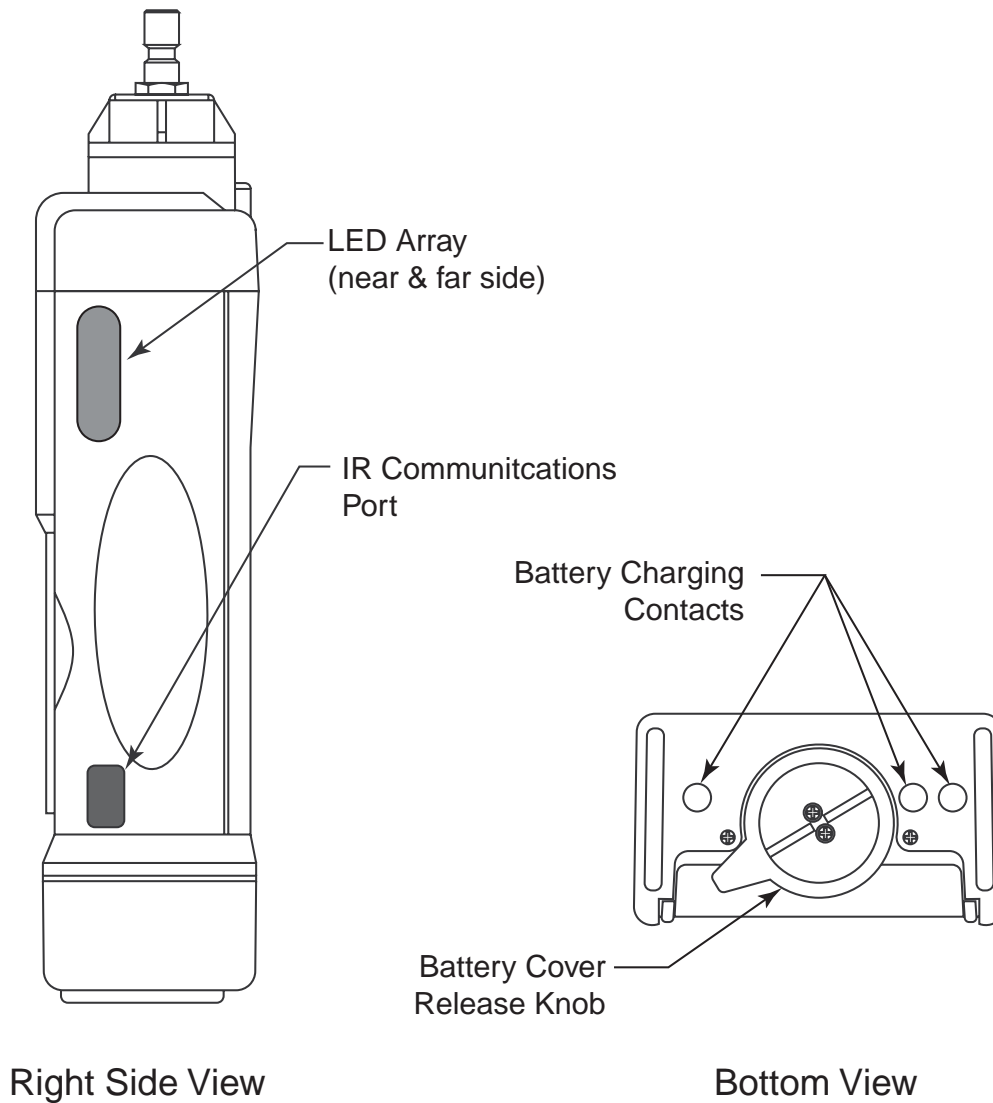

Figure 2: Components of the GX-2003, Side & Bottom

Case

The Model GX-2003's sturdy, high-impact plastic case is radio frequency (RF) resistant and is suitable for use in many environmental conditions, indoors and out. The case is dust proof and weather resistant. Rubber gripping surfaces are located on the right and left side of the case to aid in holding the unit in your hand.

A clear plastic window through which the LCD can be viewed is located on the front of the case. Three brass charging contacts that are used when the GX-2003 is placed in the charging station are on the bottom of the case. The battery cover release knob is also on the bottom. The battery cover and flow chamber are located on the back of the GX-2003. The inlet filter holder is located on the top of the GX-2003 case.

Sensors

The GX-2003 uses up to five sensors to monitor combustible gas, oxygen (O₂), carbon monoxide (CO), and hydrogen sulfide (H₂S) simultaneously. The sensors are located inside the GX-2003 and are held in their sockets by the flow chamber. The sensors use different detection principles, as described below.

Combustible Gas Sensors

% LEL Sensor (NC-6264AT)

The % LEL sensor detects combustible gas in the % LEL range. It uses a catalytic element for detection. The reaction of gas with oxygen on the catalyst causes a change in the resistance of the element which affects the current flowing through it. The current is amplified by the GX-2003's circuitry, converted to a measurement of combustible gas concentration, and displayed on the LCD.

NOTE: The % LEL sensor can not be used in instruments that utilize Bar Hole Mode or Leak Check Mode.

LEL/PPM Sensor (NC-6264ALB)

The LEL/ppm combustible sensor is a specialized version of the % LEL sensor. It is used instead of the % LEL sensor in instruments that are intended for use in Bar Hole Mode or Leak Check Mode. The LEL/ppm sensor can also be used for detection in Normal Mode.

%Volume Sensor

The % volume sensor detects combustible gas in the % volume range. It uses a thermal conductivity (TC) element for detection. The presence of combustible gas cools the element causing a change in the resistance of the element which affects the current flowing through it. The current is amplified by the GX-2003's circuitry, converted to a measurement of combustible gas concentration, and displayed on the LCD.

Oxygen Sensor

The O₂ sensor is a galvanic type of sensor. A membrane covers the cell and allows gas to diffuse into the cell at a rate proportional to the partial pressure of oxygen. The oxygen reacts in the cell and produces a voltage proportional to the concentration of oxygen. The voltage is measured by the Model GX-2003's circuitry, converted to a measurement of gas concentration, and displayed on the LCD.

CO and H₂S Sensors

The CO and H₂S sensors are electrochemical cells that consist of two precious metal electrodes in a dilute acid electrolyte. A gas permeable membrane covers the sensor face and allows gas to diffuse into the electrolyte. The gas reacts in the sensor and produces a current proportional to the concentration of the target gas. The current is amplified by the Model GX-2003's circuitry, converted to a measurement of gas concentration, and displayed on the LCD.

LCD

A digital LCD (liquid crystal display) is visible through a clear plastic window on the front of the case. The LCD display simultaneously shows the gas reading for all installed sensors. The display also shows information for each of the GX-2003's program modes.

Control Buttons

Five control buttons are located below the LCD. They are arranged in a circular pattern around a central button, the POWER ENTER button. The DISPLAY (ADJ) button is on the left, the RESET SILENCE button on the right, the ▲AIR button on the top, and the (SHIFT)▼ is on the bottom.

Table 2: GX-2003 Control Button Functions

Button	Function(s)
POWER ENTER	<ul style="list-style-type: none">• turns the GX-2003 on and off.• used during setup and calibration.
RESET SILENCE	silences and resets audible alarm if the GX-2003 is programmed for latching alarms and the alarm silence option is on ¹
DISPLAY (ADJ)	<ul style="list-style-type: none">• activates Display Mode• enters instructions into the GX-2003's microprocessor
▲AIR	<ul style="list-style-type: none">• activates the demand-zero function (automatically adjusts the GX-2003 in fresh-air conditions)• scrolls through the display and settings modes
(SHIFT)▼	<ul style="list-style-type: none">• scrolls through the display and settings modes• enters instructions into the GX-2003's microprocessor

¹ The GX-2003's alarms are user-adjustable. See "Chapter 6: Setup Mode" on page 58.

Printed Circuit Boards

The GX-2003 printed circuit boards analyze, record, control, store, and display the information collected. The circuit boards are located inside the case. They are not user serviceable.

Alarm LED Arrays

Four red alarm LED (light emitting diode) arrays are visible through frosted plastic lenses in the case. One is on the front, one on the left side, one on the right side, and one on the top of the case. The alarm LED arrays alert you to gas, low battery, and failure alarms.

Infrared Communications Port

An infrared (IR) communications port is located on the lower right side of the GX-2003. The data transmitted through the port is in standard IrDA protocol. A computer's infrared port or an IrDA/serial or IrDA/USB cable connected to a computer's serial port can be used to download data saved by the GX-2003 to a computer using the GX-2003 Downloading Software. See the downloading software operator's manual for data logging and downloading instructions.

Buzzers

Two solid-state electronic buzzers are located inside the case. Two holes on the bottom front of the case allow the sound to exit the case. The buzzers sound for gas alarms, malfunctions, low battery voltage, and as an indicator during use of the GX-2003's many display and adjustment options.

Vibrator

A vibrating motor inside the GX-2003 case vibrates for gas alarms, unit malfunctions, low battery voltage, and as an indicator during normal use of the various modes of the GX-2003.

Batteries

Three AA-size alkaline batteries (standard) or an optional rechargeable Ni-MH battery pack (3.6 VDC) power the GX-2003. Instrument run time is dependent upon battery type. At 25°C the alkaline batteries last up to 14 hours and the Ni-MH battery pack lasts up to 16 hours. The battery icon in the lower right of the LCD shows remaining battery life. If a Ni-MH battery pack is installed in the GX-2003, an "N" appears to the right of the battery icon.

When the GX-2003 detects low battery voltage, a low battery warning is activated. When battery voltage is too low for normal operation, the GX-2003 sounds a dead battery alarm.

The alkaline batteries or Ni-MH pack can be replaced by removing the battery cover on the back of the case. Turn the battery cover release knob counterclockwise to release the cover.

The Ni-MH battery pack can be recharged by placing the GX-2003 in

its optional battery charging station or by placing the battery pack in the charging station.

NOTE: Use of batteries or battery chargers not specified by RKI Instruments, Inc. will void the CSA classification and may void the warranty. See “Replacing or Recharging the Batteries” on page 76.

WARNING: To prevent ignition of a hazardous atmosphere, batteries must only be changed or charged in an area known to be nonhazardous.

Pump

A diaphragm pump inside the GX-2003 draws the sample to the sensors. It can draw sample from as far as 40 feet from the GX-2003. The pump is not user serviceable.

CAUTION: Sample hose lengths of more than 40 feet are not recommended for the GX-2003 because of flow rate reduction.

Flow Chamber

The flow chamber is on the back of the GX-2003 and is held in place by three phillips screws. The flow chamber seals on the face of the sensors inside the GX-2003 and routes flow from the pump to the sensors to the exhaust port (also a part of the flow chamber). The flow chamber includes filter ports for the HC filter and the CO filter.

HC Filter

The HC filter is located in the flow chamber directly over the % LEL sensor. It is a yellow and black plastic ring which contains two H₂S removal filter disks and a thin white plastic sheet with a hole in the middle on each side to support the H₂S removal filter disks. The yellow side of the HC filter snaps into a threaded plastic filter retainer which screws into the flow chamber over the % LEL sensor.

The H₂S removal filter disks are white when new. They scrub H₂S out of the gas sampled to increase the life of the combustible sensor. They darken as they absorb H₂S and the HC filter must be changed when the filter disks turn a dark brown color. The recommended replacement frequency will depend on how often the unit is exposed to H₂S and the concentration. Check the condition of the H₂S removal filter disks through the holes in the white plastic support sheets quarterly.

CO Filter

The CO filter is located in the flow chamber directly over the CO sensor. It is a red and black plastic ring which contains two charcoal filter disks, two H₂S removal filter disks, and a thin white plastic sheet with a hole in the middle on each side to support the filter disks. The charcoal filter disks are black, have a woven texture, and are impregnated with an H₂S absorbing material. The red side of the CO filter snaps into a threaded plastic filter retainer which screws into the flow chamber over the CO sensor.

The CO sensor will respond if exposed to H₂S and certain hydrocarbon gasses. The charcoal filter disks scrub these gasses out of the sample to avoid false CO readings. The H₂S filter disks are used to extend the H₂S absorbing life of the charcoal disks. If false or elevated CO readings are noticed, especially in the presence of H₂S, change the CO filter.

Inlet Filter Holder

The filter holder is a clear plastic dome shaped piece on the top of the case. A male quick connect fitting is located on the inlet filter holder. This is the GX-2003's inlet fitting. A cotton dust filter is inside the filter holder. The filter holder may be removed by turning it counterclockwise and pulling it away from the case. Two flat membrane disk hydrophobic filters, a wire mesh disk, and a rubber filter retaining gasket are held in place by the filter holder and are located in the bottom of the case chamber where the filter holder is installed.

Standard Accessories

The standard accessories include the tapered rubber nozzle, protective rubber boot, sample hose, and 10 inch probe. An optional bar hole probe is also available and is described at the end of this section.

Tapered Rubber Nozzle

A cone shaped 4 inch long rubber nozzle is included with the GX-2003 as standard. It can be installed on the inlet fitting by pushing the larger end over it. The smaller end can be inserted through a hole in a wall or some other access to an enclosed area to sample the environment.

Protective Rubber Boot

A protective rubber boot is provided as standard with the GX-2003. It has an integral belt clip on the back. The boot can be installed onto the GX-2003 for additional protection and to wear the GX-2003 on a belt.

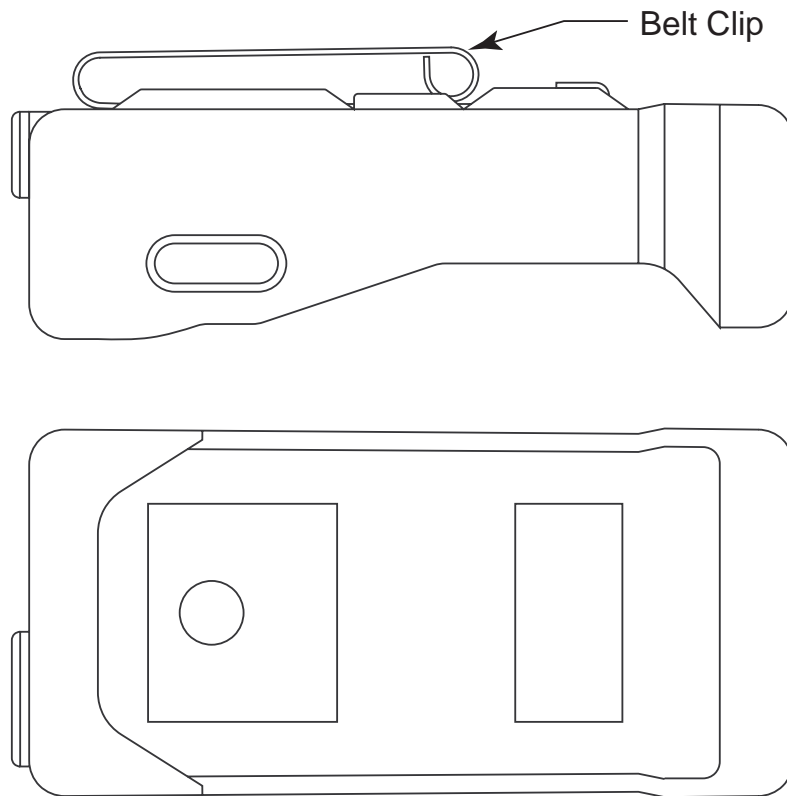

Figure 3: Protective Rubber Boot

Sample Hose & 10 Inch Probe

A 10 foot sample hose and a 10 inch probe are included as standard with the GX-2003. When desired, the rubber nozzle may be removed and the sample hose and 10 inch probe may be connected to the inlet fitting. Sample hose lengths are available from 10 feet to 40 feet (see “Parts List” on page 84). The quick connect end of the sample hose connects to the inlet fitting of the GX-2003 and the probe screws onto the end of the hose with the threaded fitting.

CAUTION: *Sample hose lengths of more than 40 feet are not recommended for the GX-2003 because of flow rate reduction.*

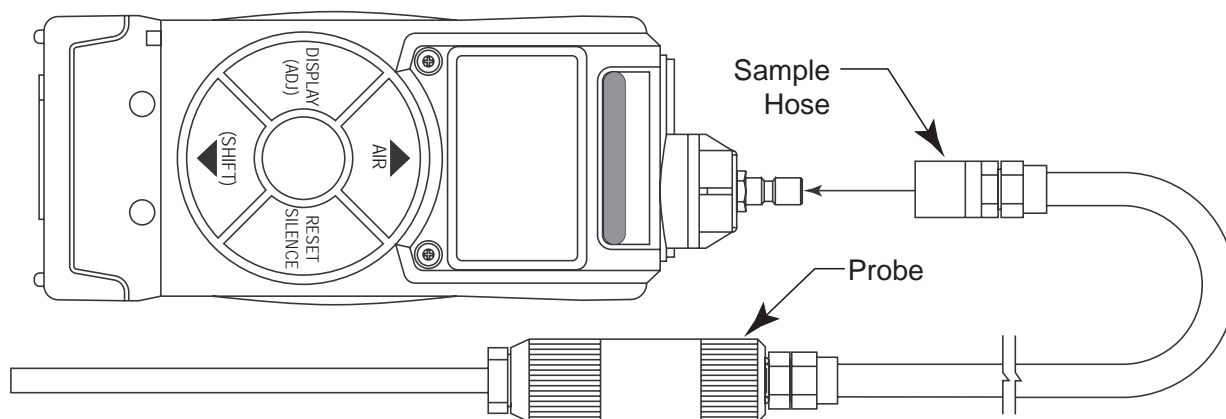

Figure 4: Sample Hose and Probe

Bar Hole Probe (Optional)

An optional bar hole probe is available for the GX-2003. It is designed to be used when the GX-2003 is operated in Bar Hole Mode to check bar holes when tracking down underground gas pipe leaks (see “Chapter 4: Using the GX-2003 in Bar Hole Mode” on page 45). The bar hole probe has the same handle as the standard probe, but has a 30 inch fiberglass tube instead of the standard tube. Four holes are drilled through the 30 inch tube’s wall near the end and the end is plugged so that debris from the barhole cannot be drawn into the tube. The sample is drawn through the drilled holes in the tube wall.

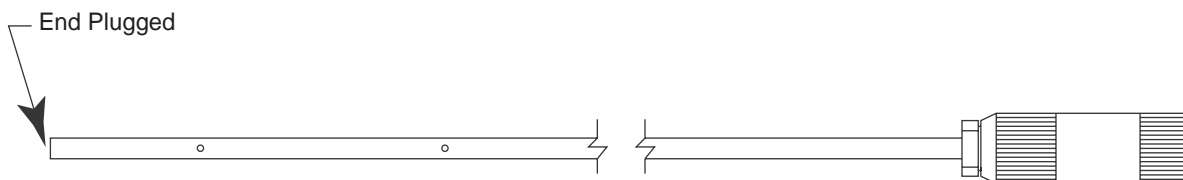

Figure 5: Bar Hole Probe

Chapter 3: Using the GX-2003 in Normal Mode

Overview

This chapter explains how to operate the GX-2003 in Normal Mode. Normal Mode is used to perform confined space entry monitoring or general area monitoring. While in Normal Mode, Display Mode and Calibration Mode are accessible.

If a standard version of the GX-2003 is ordered, it is shipped with Bar Hole Mode and Leak Check Mode disabled so that the instrument only runs in Normal Mode when turned on.

Start Up, Normal Mode

This section explains how to start up the GX-2003 in Normal Mode, get it ready for operation, and turn it off

NOTE: The screens illustrated in this section are for a 4-gas unit that has the % LEL range for the CH₄ channel. The screens displayed by your GX-2003 may be slightly different.

Turning On the GX-2003, Normal Mode Only

The following description of the GX-2003 start up sequence assumes that the following menu items in Setup Mode are turned on: LUNCH BREAK, USER/STATION ID, and CAL. TIME REMAINING. If any of these items is turned off, then the corresponding screen will not appear. This description also assumes that the LB Mode item in Setup Mode is turned off so that Bar Hole Mode and Leak Check Mode are not active.

1. Connect the tapered rubber nozzle or the sample hose to the GX-2003's quick connect inlet fitting.
2. If a sample hose is used, screw the probe onto the sample hose's threaded fitting.
3. Press and briefly hold down the POWER/ENTER button. Release the button when you hear a beep.

4. If LUNCH BREAK is turned on (see page 62), the Resume Datalog Screen displays.

```
RESUME DATALOG  ?
                4
        YES: AIR
        NO: DISPLAY
        21:09 [REDACTED]
```

- Press and release the ▲AIR button to continue accumulating time-weighted average (TWA), PEAK readings, and time in operation from the last time the GX-2003 was used. The short-term exposure limit [STEL] reading is reset each time the GX-2003 is turned on.
- Press and release the DISPLAY(ADJ) button to reset the accumulation of these measurements.

If you do not press the ▲AIR or DISPLAY(ADJ) button within 5 seconds, the GX-2003 automatically resumes accumulating the TWA, PEAK readings, and time in operation.

5. If USER/STATION ID is turned on (see page 62), the ID Screen displays for a few seconds.

```
USER ID
*****
STATION ID
*****
```

6. After the ID Screen, if CAL. TIME REMAINING is turned on, the screen that appears next depends on how CAL.EXPIRED ACTION is set in the Setup Mode Menu(page 62).
- If the unit is due for calibration and CAL. EXPIRED ACTION is set to CONFIRM TO USE, then the following screen displays.

```
CAL. DATE PAST

CAL. IS REQUIRED
```

The alarm LED's and buzzer will pulse several times and the vibrator will activate for a second. After this, press the RESET SILENCE button until you hear a beep to continue.

- If the unit is due for calibration and CAL. EXPIRED ACTION is set to CANNOT USE, then the following screen displays.

CAL. DATE PAST

NOT OPERATED

The GX-2003 cannot be used until a calibration has been performed either by selecting AUTO CALIBRATION or SINGLE CALIBRATION in the Setup Mode menu. See “Calibrating Using Auto Calibration” on page 67 or “Calibrating Using Single Calibration” on page 69 for calibration instructions.

- If calibration is not due or CAL EXPIRED ACTION is set to NO EFFECT, then the following screen appears for a few seconds indicating when the next calibration is due.

NEXT CAL. DATE

Dec/18/'03

TIME TO CAL. 45 DAYS

7. The Date/Time/Battery Level Screen appears for a few seconds.

Sept/23/'03

20:34

BATTERY: ██████

This screen displays the current date, time, and an indication of how much battery charge remains. If the battery icon is fully filled in black, then the batteries are at full charge.

8. If the GX-2003 experiences a sensor failure during start up, a screen indicating which sensor failed displays. In the example below, the H2S sensor has failed.

FAIL

SENSOR

< > < >

< > <H2S> < >

21:09 ██████

If you wish to continue, press and release the RESET SILENCE button to acknowledge the failure. The gas reading for the failed sensor will be replaced by “XXX”. Replace the failed sensor as

soon as possible.

9. The GX-2003 is now operating in Normal Mode and monitoring for gas in Measuring Mode. The Normal Operation Screen appears.

CH4	0%LEL
OXY	20.9VOL%
H2S	0.0ppm
CO	0ppm
	21:09  N

The concentrations of the target gasses are displayed along with the time and battery charge level. If an “N” appears next to the battery icon as illustrated above, the GX-2003 is being powered by Ni-MH battery pack. If no “N” appears, then alkaline batteries are powering the unit.

Turning On the GX-2003 in Normal Mode With All Modes Active

If the LB Mode item in Setup Mode is set to ON (see “Turning LB Mode Display On or Off” on page 72), then the user must select Normal Mode during the start up sequence to operate in Normal Mode. See “Chapter 4: Using the GX-2003 in Bar Hole Mode” on page 45 for a description of Bar Hole Mode and “Chapter 5: Using the GX-2003 in Leak Check Mode” on page 52 for a description of Leak Check Mode.

The following description of the GX-2003 start up sequence assumes that the following menu items in Setup Mode are turned on: LUNCH BREAK, USER/STATION ID, and CAL. TIME REMAINING. If any of these items is turned off, then the corresponding screen will not appear.

NOTE: In order for **BAR HOLE MODE** to appear as a selection in the Mode Select Screen in Step 3 below, the GX-2003 must have both a % volume combustible sensor and an LEL/PPM sensor installed. If a GX-2003 has only the LEL/PPM sensor installed, then **BAR HOLE MODE** will not appear as a choice as shown in Step 3 below and **NORMAL MODE** and **LEAK CHECK MODE** will be the only choices displayed.

1. Connect the tapered rubber nozzle or the sample hose to the GX-2003’s quick connect inlet fitting.
2. If a sample hose is used, screw the probe onto the sample hose’s threaded fitting.

3. Press and briefly hold down the POWER/ENTER button. The Mode Select Screen displays.

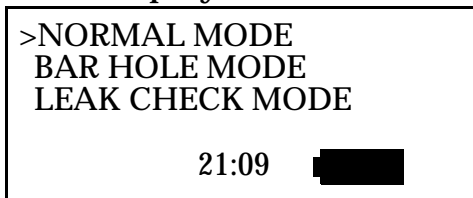

NOTE: If a “N” appears to the right of the battery icon, this indicates that a Ni-MH battery pack is being used instead of alkaline batteries.

4. The cursor will begin in front of Normal Mode and Normal Mode will flash dark and light indicating it is selected.
5. With Normal Mode selected, continue with the startup sequence as described in the previous section, “Turning On the GX-2003, Normal Mode Only”, from step 4 on page 21 on.

NOTE: If no button is pressed for 20 seconds, the unit will proceed into whichever mode has the cursor in front of it.

6. To exit Normal Mode and return to the Mode Select Screen, press and hold the (SHIFT)▼ button for 5 seconds while in the Normal Operation Screen.

Performing a Demand Zero, Normal Mode

Before using the GX-2003, it is recommended to set the fresh air readings for the target gasses by performing a demand zero. This will set the CH₄, CO, and H₂S channels to zero and the OXY channel to 20.9%.

1. Find a fresh-air environment. This is an environment free of toxic or combustible gasses and of normal oxygen content (20.9%).
2. Turn on the unit as described above in “Turning On the GX-2003, Normal Mode Only” or “Turning On the GX-2003 in Normal Mode With All Modes Active”.
3. Press and hold the ▲AIR button. The display prompts you to hold the ▲AIR button.
4. Continue to hold the ▲AIR button until the display prompts you to release the ▲AIR button. The GX-2003 will set the fresh air reading for all channels. Start up is complete and the unit is now ready for monitoring.

Turning Off the GX-2003, Normal Mode

1. Press and hold the POWER ENTER button.
2. The buzzer will sound and the LCD back light will flash for about five seconds.
3. Release the button when GOODBYE appears on the display. When GOODBYE disappears and the backlight turns off, the unit is off.

Measuring Mode, Normal Operation

The GX-2003 has three operating modes within Normal Mode: Measuring Mode, Display Mode, and Calibration Mode. This section describes using the GX-2003 in Measuring Mode during normal operation.

In Measuring Mode the GX-2003 continuously monitors the sampled atmosphere and displays the gas concentrations present for its target gases. In a low-light environment, press and release any button to turn on the display backlight. See “Updating the LCD Back Light Time Setting” on page 71 to program backlight duration. If CONFIRMATION BEEP is turned on in the Setup Mode menu, the GX-2003 beeps once every 15 minutes to confirm that it’s operating.

Monitoring an Area

1. Start up the GX-2003 as described above in “Start Up, Normal Mode” on page 20 or “Turning On the GX-2003 in Normal Mode With All Modes Active”. It is now in Measuring Mode
2. Take the GX-2003 to the monitoring area.

If the tapered rubber nozzle is used, put the nozzle tip in the area to be monitored.

If the hose and probe is used, put the probe tip in the area to be monitored.
3. Wait 10 - 15 seconds and observe the display for gas readings. If a reading is observed, allow the reading to stabilize to determine the gas concentrations present.

NOTE: Response time increases with the length of the sample hose. Long sample hoses will require more time to show a response at the GX-2003. The maximum sample hose length recommended for the GX-2003 is 40 feet. Consult RKI

Instruments, Inc. for longer sample hose lengths.

4. If a gas alarm occurs, take appropriate action. See “Responding to Alarms” on page 30.

Combustible Gas Detection

The GX-2003 can support two combustible gas sensors, a TC (thermal conductivity) sensor for detection in the % volume range, and a catalytic sensor for detection in the % LEL range. Either or both sensors may be installed in your unit.

If both the % volume and % LEL sensors are installed, the CH₄ channel is setup at the factory as % LEL/% volume autoranging. In this case, the CH₄ channel will display the combustible gas concentration in % LEL up to 100% LEL. If the combustible gas concentration rises above 100% LEL, then the unit automatically begins displaying the concentration in % volume.

CAUTION: *If the combustible channel is set for %volume only, then there are no gas alarms for any detection channel. See “HC Range Screen” on page 32.*

There are three issues to keep in mind when monitoring for combustible gas.

- If your GX-2003 is equipped with both combustible sensors, then the % LEL sensor will be exposed to combustible gas concentrations above its working range during monitoring and calibration. The GX-2003 provides the % LEL sensor with protection against exposure to high levels of combustible gas. It does this by turning off the % LEL sensor power temporarily when it determines that a %LEL over scale (more than 100% LEL) concentration of combustible gas is present that may damage the sensor. When this happens, “OVER” is displayed to the right of the reading and the display units change to % volume.
- Silicone vapors and chlorine and fluorine compounds, such as chlorinated hydrocarbons, can damage the %LEL sensor. These compounds should be avoided. If exposure to these compounds is suspected, verify the %LEL response on a known gas sample.
- Although the GX-2003 CH₄ channel is setup for and calibrated to methane (CH₄), the combustible sensors will respond to other combustible gasses as well.

The table below lists the conversion factors for several hydrocarbon gasses **for the % LEL combustible sensor if it is calibrated to methane**. Conversion factors are not available for the % volume TC sensor. To use this table, multiply the display reading on the CH4 channel by the factor in the appropriate row to obtain the actual gas concentration. For example, if you are detecting pentane and the display reads 10% LEL on the CH4 channel, you actually have 10% LEL x 1.35 = 13.5% LEL pentane present.

Table 3: LEL Hydrocarbon Conversions

Gas	LEL Conversion Factor (Methane Calibration)	Gas	LEL Conversion Factor (Methane Calibration)
Acetone	1.92	Iso Butane	1.56
Acetylene	2.00	MEK	1.92
Benzene	2.00	Methane	1.00
Ethane	1.25	Methanol	1.65
Ethanol	1.75	Pentane	1.35
Ethylene	1.20	Propane	1.52
Heptane	1.92	Propylene	1.33
Hexane	1.65	Toluene	2.00
Hydrogen	1.00	Xylene	0.93
IPA	2.50		

Measuring Mode, Alarms

This section covers alarm indications in Measuring Mode. It also tells you how to reset the GX-2003 after an alarm has occurred and how to respond to an alarm condition.

NOTE: False alarms may be caused by radio frequency (RF) or electromagnetic (EMI) interference. Keep the GX-2003 away from RF and EMI sources such as radio transmitters or large motors.

Alarm Indications

CAUTION: *If the combustible channel is set for %volume only, then there are no gas alarms for any detection channel. See “HC Range Screen” on page 32.*

The GX-2003 will sound an alarm, the unit will vibrate, and the LED arrays will flash when one of the target gas concentrations rises above the Alarm 1 level, or in the case of oxygen, falls below the Low Alarm setting for that gas.

The Model GX-2003 also sounds an alarm, vibrates, and flashes the LED arrays when the Alarm 2 level is reached for CH₄, CO, and H₂S, when the concentration of oxygen rises above the High Alarm level, and when the STEL and TWA alarm points are reached for CO and H₂S.

When a failure condition occurs, such as a sensor failure, low flow, or dead battery condition, the unit will also sound an alarm, flash the LED arrays, and vibrate.

The table below summarizes the types of alarms produced by the GX-2003.

Table 4: Alarm Types and Indications

Alarm Type	Visual Indications	Other Indications
Low Alarm Concentration of gas rises above the low alarm level, or falls below the Low Alarm level for O ₂ .	<ul style="list-style-type: none">• ALM1 appears blinking next to gas reading• Alarm LED arrays flash once per second.	<ul style="list-style-type: none">• Pulsing tone once per second• Unit vibrates once per second
High Alarm Concentration of gas rises above the Alarm 2 level, or rises above the High Alarm level for O ₂ .	<ul style="list-style-type: none">• ALM2 appears blinking next to gas reading• Alarm LED arrays flash twice per second	<ul style="list-style-type: none">• Pulsing tone twice per second• Unit vibrates twice per second
TWA or STEL Concentration of CO or H ₂ S rises above the TWA or STEL alarm point setting.	<ul style="list-style-type: none">• Alarm LED arrays flash once per second• Back light turns on.• TWA or STEL appears blinking next to gas reading	<ul style="list-style-type: none">• Pulsing tone once per second• Unit vibrates once per second

Table 4: Alarm Types and Indications

Alarm Type	Visual Indications	Other Indications
Over Range*	<ul style="list-style-type: none"> Gas reading indicates full scale. Alarm LED arrays flash Back light turns on. 	<ul style="list-style-type: none"> Pulsing tone once per second Unit vibrates once per second
Low Flow*	<ul style="list-style-type: none"> The display indicates FAIL LOW FLOW LEVEL The Alarm LED's flash 	<ul style="list-style-type: none"> Rapid pulsing tone Unit vibrates every few seconds
Low Battery Warning*	<ul style="list-style-type: none"> Battery icon blinks 	<ul style="list-style-type: none"> None
Dead Battery Alarm*	<ul style="list-style-type: none"> Gas readings replaced by Change the Batteries Alarm LED arrays flash 	Rapid pulsing tone alternating with vibration
Sensor Failure*	<ul style="list-style-type: none"> FAIL SENSOR appears at the top of the display and the failed sensor(s) are indicated Alarm LED arrays flash 	Rapid pulsing tone alternating with vibration
*This alarm can also occur in Bar Hole Mode and Leak Check Mode		

Resetting and Silencing Alarms

You can set the GX-2003's gas alarms as latching or self-resetting alarms (see "Updating the Alarm Latching Setting" on page 62).

- Self-resetting alarms (ALARM LATCHING set to OFF)

Self-resetting alarms automatically shut off and reset when the gas reading falls below (or rises above for an oxygen low alarm) the alarm setting. You cannot silence or reset self-resetting alarms.

- Latching alarms (ALARM LATCHING set to ON)

You can set latching alarms with or without Alarm Silence (see "Updating the Alarm Silence Setting" on page 62).

With ALARM SILENCE On and ALARM LATCHING On:

When the GX-2003 goes into gas alarm, press the RESET SILENCE button to silence the buzzer. If the gas concentration was still above

the alarm level when the button was pressed, the LEDs continue to flash, and the GX-2003 continues to display the current alarm level.

The gas reading must fall below (or rise above for an oxygen low alarm) the low alarm setting before you can reset the alarm. Press the RESET SILENCE button to reset the alarm. The LEDs turn off and the GX-2003 alarm indications on the display turn off.

With ALARM SILENCE OFF and ALARM LATCHING ON:

The gas reading must fall below (or rise above for an oxygen low alarm) the low alarm setting before you can reset the alarm. Press the RESET SILENCE button to reset the alarm. The LEDs and buzzer turn off and the GX-2003 alarm indications on the display turn off.

NOTE: With ALARM SILENCE set to OFF in Setup Mode, you cannot silence the buzzer while the gas reading is above (below for an oxygen Low Alarm) the low alarm setting.

Responding to Alarms

This section describes response to gas, over range, battery, and sensor failure alarms.

Responding to Gas Alarms

1. Determine which gas alarm has been activated.
2. Follow your established procedure for an increasing gas condition or a decreasing oxygen condition.
3. If necessary, reset the alarm using the RESET SILENCE button once the alarm condition has been cleared.

Responding to Over Range Alarms

WARNING: An over range condition may indicate an extreme combustible gas, toxic gas, or oxygen concentration. Confirm a normal condition with a different GX-2003 or with another gas detecting device.

1. Determine which gas alarm has been activated.
2. Follow your established procedure for an increasing gas condition.
3. Reset the alarm using the RESET SILENCE button once the alarm condition has cleared.
4. Calibrate the GX-2003 as described in the calibration section of this manual.

5. If the over range condition continues, you may need to replace the sensor that has triggered the over range alarm.
6. If the over range condition continues after you have replaced the sensor, contact RKI Instruments, Inc. for further instructions.

Responding to Battery Alarms

WARNING: The GX-2003 is not operational as a gas monitoring device during a dead battery alarm. Take the Model GX-2003 to a non-hazardous area and replace or recharge the batteries as described in “Replacing or Recharging the Batteries” on page 76

The Model GX-2003 is fully functional during a low battery warning. However, only a limited amount of operating time remains, approximately 1 - 2 hours. The amount of time depends on how often the LCD backlight is used and how often the unit is responding to alarm conditions. Recharge the battery pack or replace the alkaline batteries as soon as possible as described in “Replacing or Recharging the Batteries” on page 76.

NOTE: Alarms and the back light feature consume battery power and reduce the amount of operating time remaining.

Responding to Sensor Failure Alarms

1. Determine which sensor has triggered the sensor failure alarm.
2. Try calibrating the sensor first, as described in “Calibration Mode” on page 38 before replacing it.
3. If the sensor failure continues, replace the sensor as described in “Replacing a Sensor” on page 80.
4. If the sensor failure condition continues after you have replaced the sensor, contact RKI Instruments, Inc. for further instructions.

Display Mode

This section describes using the GX-2003 in Display Mode. With the GX-2003 in Display Mode, you can:

- set the CH4 channel range
- set the user ID and station ID
- display peak readings

- display time in operation
- display TWA and STEL readings (*H₂S and CO only*)
- display the date, time, and battery charge
- clear the data logger
- display remaining log time

To enter Display Mode, press and release the DISPLAY (ADJ) button while in Measuring Mode. To scroll from one screen to the next press and release the DISPLAY (ADJ) button.

NOTE: Each screen displays for 20 seconds. If you do not press the DISPLAY (ADJ) button to scroll to the next screen within 20 seconds, the GX-2003 automatically returns to Measuring Mode.

HC Range Screen

This screen displays only if your GX-2003 is equipped with both the catalytic % LEL combustible sensor and the TC % volume combustible sensor. It allows you to select the display units for the combustible channel as % LEL/% volume autoranging or % volume. If autoranging is selected, the CH₄ reading will be displayed in % LEL up to 100% LEL, which is equivalent to 5% volume for methane (CH₄). Above 100% LEL, it will be displayed in %volume. If % volume is selected, the CH₄ reading will be displayed in % volume only.

CAUTION: *If the combustible channel is set for % volume only, then there are no gas alarms for any detection channel.*

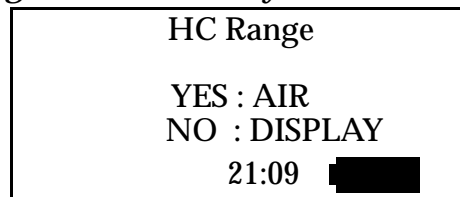

To update the HC range setting:

1. After entering Display Mode and arriving at the HC range screen, press and release the ▲AIR button. The current setting will flash at the bottom of the LCD.
2. Use the ▲AIR or (SHIFT)▼button to change the setting.
3. Press the POWER ENTER button to save the change and advance to the next screen.

ID Screen

This screen displays only if USER/STATION ID in the Setup Mode menu is set to ON (see “Turning the User/Station ID Function On or Off” on page 67). Each ID contains 10 characters. Uppercase letters, numbers, asterisks (*), dashes (-), and a blank space are available characters.

Use this screen to identify the user, location, or other information. The user ID and station ID provide a way to identify the user and location of exposure during a data logging session. The user ID and station ID are saved to the data logger for that session when you turn off the GX-2003, so you can update the ID's for each data logging session if desired.

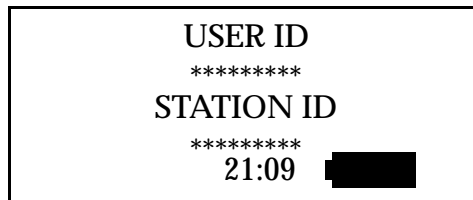

To enter a user and station ID:

1. After entering Display Mode and proceeding to the ID screen, press and hold the (SHIFT) button, then press the DISPLAY (ADJ) button and release both buttons. The first character under USER ID flashes (* is default).
2. Press the ▲AIR and (SHIFT)▼ buttons to scroll through the available characters. (The asterisk, dash, and blank space are between the set of letters and numbers.)
3. When the desired character displays, press and release the POWER ENTER button to enter the character and go to the next character.

NOTE: To exit the ID screen while entering characters without saving the updates, press the DISPLAY (ADJ) button twice. You will advance to the peak screen without saving any ID updates.

4. Repeat steps 2 and 3 for the remaining 19 characters. When the final character of the station ID is entered, then both ID's are saved.
5. Press and release the DISPLAY(ADJ) button to advance to the Peak Screen.

Peak Screen

The peak screen displays the highest (lowest for O₂) concentrations detected since the GX-2003 was turned on. Peak readings are stored in the GX-2003's memory until a higher level is detected, the peak reading is reset, or the GX-2003 is turned off.

The lunch break feature enables the GX-2003 to remember peak readings when it is turned off so it can continue them when it is turned on again. See "Turning On the GX-2003, Normal Mode Only" on page 20. To reset the peak readings during operation, press and hold the RESET SILENCE button for a few seconds while in the peak screen.

P CH4	0%LEL
E OXY	20.9VOL%
A H2S	0.0ppm
K CO	0ppm
	21:09 

Elapsed Time Screen

The elapsed time screen displays the time in minutes since the GX-2003 was last turned on. The elapsed time may be continued from the last time the GX-2003 was in operation by using the lunch break option. See "Turning On the GX-2003, Normal Mode Only" on page 20.

TIME IN OPERATION
30 MINUTES
21:09 

TWA/STEL Screen

The TWA/STEL screen displays the time-weighted average (TWA) and the short-term exposure limit (STEL) readings *for CO and H2S only*.

The TWA reading is the average reading *during the last 8 hours*. If 8 hours have not elapsed since the last time the TWA reading was cleared, the average is still calculated over 8 hours. The missing time is assigned a 0 value (20.9% for oxygen) for readings.

The STEL reading is the average reading *during the last 15 minutes*.

	TWA	STEL
H2S	0.0	0.0ppm
CO	0	0ppm
	21:09	■

Date/Time/Battery Charge Screen

The date/time/battery charge screen displays the current date, time, and battery charge level. If the battery icon is fully filled in black, then the batteries are fully charged.

Sept/23/'03
20:34
BATTERY: ■

Clear Data Logger Screens

CAUTION: *Once you clear the data logger, you cannot retrieve any data previously stored in the data logger.*

NOTE: The GX-2003 does not log data during the first minute of operation after being turned on, so this screen will not appear during the first minute of operation after start up.

The clear data logger screens allow you to clear the data logger storage. (Press and release the DISPLAY(ADJ) button to go to the Remaining Log Time screen). You can set the GX-2003 to overwrite the oldest data when the data log is full. See “Updating the Datalog Overwrite Setting” on page 63.

CLEAR DATA LOGGER YES :AIR NO :DISPLAY 21:09 ■
--

To clear the data log:

1. With the above screen displayed, press and release the ▲AIR button.

A confirmation message displays.

ARE YOU SURE ? YES :AIR NO :DISPLAY 21:09 ■
--

2. Press and release the ▲AIR button to confirm that you want to clear the data logger.

The GX-2003 displays **CLEARING THE DATA LOGGER PLEASE WAIT** for several seconds, then displays **CLEARED OK**. The data logger is cleared and the remaining log time value is reset.

Remaining Log Time Screen

The remaining log time screen displays the time remaining until the data logger memory is full. The remaining log time depends on how often the GX-2003 stores data to the data log, how many channels are active, and how often the GX-2003 is turned on and off.

The table below illustrates how much data logging time is available for the various interval times. It assumes that the unit is setup with all 5 sensors, is only turned on once, and there are no alarm occurrences. See “Updating the Interval Time Setting” on page 63 for instructions on setting the data logging interval time.

Table 5: Data Logging Capacity, 5 Sensor GX-2003

Interval Time	Data Logging Time
10 seconds	10 hours
20 seconds	20 hours
30 seconds	30 hours
1 minute	60 hours
3 minutes	180 hours
5 minutes	300 hours
10 minutes	600 hours

<p style="text-align: center;">LOG TIME 9.9 HOURS REMAINING 21:09 ██████</p>
--

Press and release the DISPLAY(ADJ) button once more to return to Measuring Mode.

Data Logging

NOTE: The GX-2003 only logs data while in Normal Mode. If the GX-2003 is used in Bar Hole Mode or Leak Check Mode, no downloadable data will be logged while it is in either of these two modes.

NOTE: The GX-2003 does not log data during the first minute of operation after being turned on.

The GX-2003 features the ability to log data to its internal memory and download it to a computer via the infrared communications port on the lower right side. It logs gas readings during normal operation, alarm data, and calibration data.

To utilize the GX-2003's downloading capability, you will need the GX-2003 downloading software and a computer with an infrared port, a USB port, or a serial port that runs one of the following operating systems: Windows 98, Windows 2000, or Windows XP. If your computer has an infrared port, then no additional accessories are needed to download data from the GX-2003. If your computer does not have an infrared port but does have a USB or serial port, a USB/IrDA adapter cable or a serial/IrDA adapter cable can be used to download data from the GX-2003 using a USB or serial port. The downloading software is available from RKI Instruments, Inc. The adapter cables are also available from RKI or may be purchased at a computer or electronics supply store.

For a complete description of the downloading software and procedures for downloading data to a computer, see the GX-2003 Downloading Software Operator's Manual.

Data Cal 2000

The GX-2003 can be used with the Data Cal 2000 Docking Station. The Data Cal 2000 can charge the GX-2003's rechargeable battery pack if it is used, retrieve data, bump test and calibrate the GX-2003, and store records of bump tests and calibrations. The Data Cal 2000 is available from RKI Instruments, Inc. For a complete description of the Data Cal 2000, see the Data Cal 2000 Operator's Manual.

Calibration Mode

Calibration mode allows you to calibrate the GX-2003's sensor response. It also includes a menu item which allows you to adjust the LCD contrast.

CAUTION: BEFORE EACH DAY'S USAGE SENSITIVITY IN THE % LEL RANGE MUST BE TESTED ON A KNOWN CONCENTRATION OF THE COMBUSTIBLE TARGET GAS, METHANE, EQUIVALENT TO 25 - 50% OF FULL SCALE CONCENTRATION (The % LEL full scale is 100% LEL). ACCURACY MUST BE WITHIN -0 to + 20% OF ACTUAL. ACCURACY MAY BE CORRECTED BY FOLLOWING THE CALIBRATION INSTRUCTIONS FOR THE COMBUSTIBLE CHANNEL BELOW.

If the combustible channel passes the above response test and does not require calibration, the unit should still be calibrated periodically. The optimum frequency of calibration depends heavily on how the GX-2003 is used. For example, instruments used daily may need to be calibrated weekly or monthly, while instruments that are used only a few times a year may need to be calibrated before each use. Typical calibration frequencies range from monthly to quarterly. Make sure to perform the combustible channel response test as described above and make sure to develop a calibration schedule tailored to your application that takes this test and required calibration resulting from this test into account.

You can program the GX-2003 to notify you when it is due for calibration. See "Updating the Calibration Time Remaining Setting" on page 65.

Calibration Supplies and Equipment

To calibrate the GX-2003, you will need:

- Known calibrating samples of the gasses being detected. The combustible and toxic gas samples should have concentrations in approximately the middle of the range of detection. An oxygen-free source, such as 100% nitrogen is recommended for setting the oxygen zero.
- A demand-flow regulator to provide adequate sample gas flow
- Non-absorbent tubing

WARNING: If you are using a calibration kit that includes a gas bag and a fixed flow regulator or dispensing valve, do not apply gas directly to the GX-2003 with the regulator or valve or damage to the pump will result. See “Appendix A: Calibrating with a Sample Bag” on page 86 for instructions to properly use a gas bag kit.

To calibrate the %LEL, Oxygen, CO, and H₂S sensors at the same time, automatically, with no need for a zero-oxygen source, you can use the auto calibration feature with a 4-gas cylinder. If the H₂S channel is not active, then a 3-gas cylinder may be used for auto-calibration. This section includes instructions for auto calibration with a demand-flow regulator and a 4-gas cylinder. This section also includes instructions for calibrating one channel at a time using single calibration.

Preparing for Calibration

Whether you will calibrate the Model GX-2003 using auto calibration or single calibration, you will need to set the fresh air readings first before setting the span readings for each gas.

1. Find a fresh-air environment. This is an environment free of toxic or combustible gasses and of normal oxygen content (20.9%).
2. Turn on the unit as described in “Turning On the GX-2003, Normal Mode Only” on page 20 using the sample hose and probe.
3. With the unit on, perform a demand zero by pressing and holding the ▲AIR button. The display prompts you to hold the ▲AIR button.
4. Continue to hold the ▲AIR button until the display prompts you to release the ▲AIR button. The GX-2003 will set the fresh air reading for all channels.
5. Install the demand flow regulator onto the calibration cylinder.
6. Connect the sample tubing to the demand flow regulator.

Calibrating the GX-2003

From Measuring Mode, enter Calibration Mode by pressing and holding the (SHIFT)▼ button, then pressing the DISPLAY(ADJ) button and releasing both. If the unit prompts you for the password, enter it by using the ▲AIR and (SHIFT)▼ buttons to select each password number and then pressing and releasing POWER ENTER to enter it and move on to the next one. The calibration menu displays with the cursor next to **AUTO CALIBRATION**.

NOTE: The following screens illustrate a four-gas GX-2003 with both a % LEL and a % volume combustible sensor as examples only. Your GX-2003 may display slightly different screens.

>AUTO CALIBRATION SINGLE CALIBRATION CONTRAST NORMAL OPERATION 21:09
--

The GX-2003's calibration menu includes two methods of calibration: auto calibration and single calibration.

- **Auto Calibration:** This method allows you to calibrate the CH₄(%LEL sensor only), OXY, H₂S, and CO sensors simultaneously. It is designed for use with the RKI 4-gas calibration cylinder and is the quickest and easiest method to calibrate the GX-2003.
- **Single Calibration:** This method allows you to calibrate one sensor at a time. Use this method if you are only calibrating one or two sensors, if you are calibrating the %volume combustible sensor, or if you are not using the RKI 4-gas calibration cylinder.

Calibrating with the Auto Calibration Method

This section describes calibration using the auto calibration method. To calibrate using the single calibration method, see “Calibrating with the Single Calibration method” on page 42.

1. With the cursor next to the **AUTO CALIBRATION** menu item, press and release the POWER ENTER button to display the calibration values screen.

C CH4	50%LEL
A OXY	12.0VOL%
L H2S	25.0ppm
. CO	50ppm
21:09	

The gas concentrations displayed in the calibration values screen must match the gas concentrations listed on the 4-gas calibration cylinder. If *all* concentrations match, go to step 6. If *one or more* concentrations do not match, continue with step 2.

2. To adjust the values on the screen, hold down the (SHIFT)▼ button, then press the DISPLAY(ADJ) button and release both. The CH₄ calibration value begins to flash.

3. If necessary, use the ▲AIR and (SHIFT)▼ buttons to set the correct combustible gas value.
4. Press and release the POWER ENTER button to enter the new setting. The OXY calibration value begins to flash.
5. Repeat steps 3 and 4 to set the correct values for the remaining channels. After the last channel is set, you return to the calibration values screen and the values are no longer flashing.

NOTE: The RKI Four Gas Cylinder typically contains 12% O₂ by volume. Be sure to set the “OXY” reading to agree with the concentration listed on the cylinder’s label, not zero.

6. With the calibration values screen displayed, press the POWER/ENTER button. **CAL.** along the left side of the LCD begins to flash and the current gas readings are displayed.

C CH4	0%LEL
A OXY	20.9VOL%
L H2S	0.0ppm
. CO	0ppm
	21:09 ■■■■■

7. Connect the tubing from the demand flow regulator to the rigid tube on the probe. Allow the gas to flow for one minute.
8. Press and release the POWER/ENTER button to set the calibration to the programmed values.

If all channels passed calibration, **AUTO CALIBRATION PASS** displays, then the calibration menu displays.

If any of the sensors cannot calibrate to the proper value, **FAIL PUSH AIR KEY** displays and the GX-2003 lists the sensor(s) that failed to calibrate. In the example below, the OXY and H2S channels failed calibration. The other sensors calibrated normally.

FAIL	
PUSH AIR KEY	
<	> < >
<O2 >	< > <CO >
	21:09 ■■■■■

The buzzer, vibrator, and alarm lights activate. Press and hold the ▲AIR button for a few seconds to reset the alarm and return to the calibration menu. Attempt to calibrate again. If the failure continues, investigate the cause. See “Troubleshooting” on page 74.

9. Disconnect the tubing from the probe.
10. Unscrew the demand flow regulator from the calibration cylinder.
11. Use the (SHIFT)▼ button to place the cursor next to the **NORMAL OPERATION** menu option, then press and release the POWER ENTER button to return to Measuring Mode.

Calibrating with the Single Calibration method

This section describes calibration using the Single Calibration method. To calibrate using the Auto Calibration method, see “Calibrating with the Auto Calibration Method” on page 40.

CAUTION: *The single calibration method does not have a “FAIL” notification. If a sensor cannot be set to agree with the calibration source, see “Troubleshooting” on page 74.*

1. While in the calibration menu, use the ▲AIR or (SHIFT) ▼ button to place the prompt next to the **SINGLE CALIBRATION** menu option.

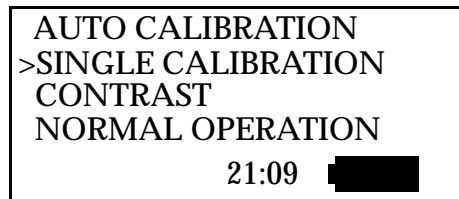

2. Press and release the POWER/ENTER button to display the single calibration menu.

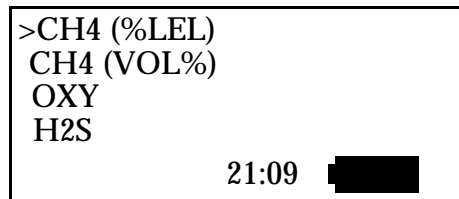

NOTE: To display the CO sensor, use the (SHIFT)▼ button to move the cursor to the bottom of the screen and then press it again to advance to the next screen.

3. Use the ▲AIR or (SHIFT)▼ button to place the cursor next to the sensor you want to calibrate (in this example the combustible gas % LEL sensor).

4. Press and release the POWER/ENTER button. The single calibration screen displays for the sensor you selected. The gas reading flashes.

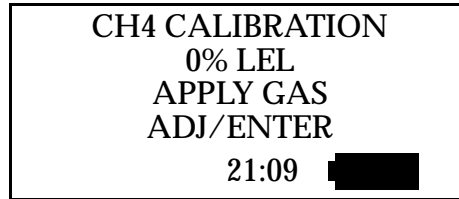

5. Connect the tubing from the demand flow regulator to the rigid tube on the probe. Allow the calibration gas to flow for one minute.
6. If necessary, use the ▲AIR and (SHIFT)▼ buttons to adjust the reading to match the concentration listed on the calibration cylinder.
7. Press and release the POWER ENTER button to save the span value. The LCD will indicate that the calibration has ended, then the single calibration menu displays.
8. Disconnect the tubing from the GX-2003's probe.
9. Repeat steps 3 through 8 for any other channels you want to calibrate. Make sure you use an appropriate calibration cylinder for each channel.

CAUTION: *When calibrating the oxygen channel, verify the concentration of oxygen listed on the cylinder's label. For oxygen-free samples (100% nitrogen for example), set the oxygen zero setting to 0.0%.*

10. After the last channel is calibrated, disconnect the calibration tubing from the probe, then unscrew the demand flow regulator from the calibration cylinder.
11. With the Single Calibration menu displayed, press the (SHIFT)▼ button until the cursor is next to the **ESCAPE** menu item.
12. Press and release the POWER ENTER button to return to the calibration menu.
13. Use the (SHIFT)▼ button to place the cursor next to the **NORMAL OPERATION** menu item, then press and release the POWER ENTER button to return to Measuring Mode.

Adjusting the LCD Contrast

The contrast setting controls the LCD contrast. Select the setting so the characters on the display are easy to see. It can be set from 0 to 15. The higher the setting, the darker the characters and LCD background.

1. From Measuring Mode, enter Calibration Mode by pressing and holding the (SHIFT)▼ button, then pressing the DISPLAY(ADJ) button and releasing both. If the unit prompts you for the password, enter it by using the ▲AIR and (SHIFT)▼ buttons to select each password number and then pressing and releasing POWER ENTER to enter it and move on to the next one. The calibration menu displays with the cursor next to **AUTO CALIBRATION**.
2. Use the (SHIFT)▼ button to place the cursor next to the **CONTRAST** menu item.

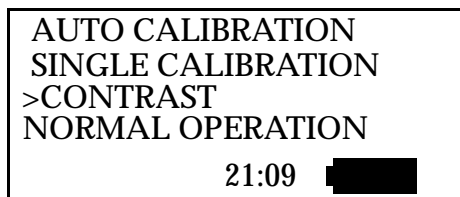

```
AUTO CALIBRATION
SINGLE CALIBRATION
>CONTRAST
NORMAL OPERATION
21:09 [Battery Icon]
```

3. Press and release the POWER ENTER button. The contrast adjust screen appears.

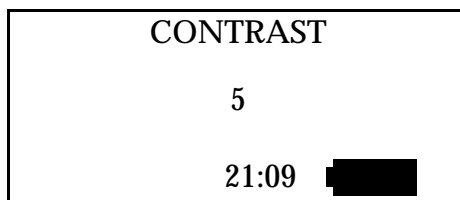

```
CONTRAST
5
21:09 [Battery Icon]
```

4. Use the ▲AIR or (SHIFT)▼ button to adjust the setting until the characters on the LCD are easy to see.
5. Press and release the POWER ENTER button to save the setting and return to the calibration menu.
6. Use the (SHIFT)▼ button to place the cursor next to the **NORMAL OPERATION** menu item, then press and release the POWER ENTER button to return to Measuring Mode.

Chapter 4: Using the GX-2003 in Bar Hole Mode

Overview

This chapter explains how to operate the GX-2003 in Bar Hole Mode. Bar Hole Mode is used to perform consistent checks of bar holes when tracking down underground gas leaks. When the GX-2003 is in Bar Hole Mode, only the combustible and oxygen sensors are displayed.

If a GX-2003 is intended for bar hole testing, it is shipped with Bar Hole Mode and Leak Check Mode enabled so that the operator must choose which operational mode to use when the unit is turned on (see “Turning LB Mode Display On or Off” on page 72).

Start Up, Bar Hole Mode

This section explains how to start up the GX-2003 in Bar Hole Mode and get it ready for operation.

Turning On the GX-2003, Bar Hole Mode

WARNING: If a CO or H₂S sensor is installed, these sensors will not be active while the GX-2003 is in Bar Hole Mode.

WARNING: Gas alarms are not active when the GX-2003 is in Bar Hole Mode.

The following description of the GX-2003 start up sequence assumes that the following menu items in Setup Mode are turned on: USER/STATION ID, and CAL. TIME REMAINING. If either of these items is turned off, then the corresponding screen will not appear.

NOTE: In order for **BAR HOLE MODE** to appear as a selection in the Mode Select Screen in Step 3 below, the GX-2003 must have both a % volume combustible sensor and an LEL/PPM sensor installed. If a GX-2003 has only the LEL/PPM sensor installed, then **BAR HOLE MODE** will not appear as a choice as shown in Step 3 below and **NORMAL MODE** and **LEAK CHECK MODE** will be the only choices displayed. In this case, see “Turning On the GX-2003 in Normal Mode With All Modes Active” on page 23 or “Turning On the GX-2003, Leak Check Mode” on page 52.

1. Connect the sample hose to the GX-2003's quick connect inlet fitting.
2. Screw the bar hole probe onto the sample hose's threaded fitting.
3. Press and briefly hold down the POWER/ENTER button. The Mode Select Screen displays.

```

>NORMAL MODE
BAR HOLE MODE
LEAK CHECK MODE

                21:09 [Battery Icon] N
  
```

NOTE: If a "N" appears to the right of the battery icon, this indicates that a Ni-MH battery pack is being used instead of alkaline batteries.

4. The cursor will begin in front of Normal Mode and Normal Mode will flash dark and light indicating it is selected. Use the (SHIFT)▼ button to move it in front of Bar Hole Mode.
5. With Bar Hole Mode selected, press and release the POWER/ENTER button to begin the Bar Hole Mode startup sequence.

NOTE: If no button is pressed for 20 seconds, the unit will proceed into whichever mode has the cursor in front of it.

6. If USER/STATION ID is turned on (see page 62), the ID Screen displays for a few seconds.

```

                USER ID
                *****
                STATION ID
                *****
  
```

7. After the ID Screen, if CAL. TIME REMAINING is turned on, the screen that appears next depends on how CAL.EXPIRED ACTION is set in the Setup Mode Menu(page 62).

- If the unit is due for calibration and CAL. EXPIRED ACTION is set to CONFIRM TO USE, then the following screen displays.

```

                CAL. DATE PAST

                CAL. IS REQUIRED
  
```

The alarm LED's and buzzer will pulse several times and the vibrator will activate for a second. After this, press the RESET SILENCE button until you hear a beep to continue.

- If the unit is due for calibration and CAL. EXPIRED ACTION is set to CANNOT USE, then the following screen displays.

```
CAL. DATE PAST  
  
NOT OPERATED
```

The GX-2003 cannot be used until a calibration has been performed by selecting AUTO CALIBRATION in Setup Mode Menu. See "Calibration Mode" on page 38 for calibration instructions.

- If calibration is not due or CAL EXPIRED ACTION is set to NO EFFECT, then the following screen appears for a few seconds indicating when the next calibration is due.

```
NEXT CAL. DATE  
Dec/18/'03  
TIME TO CAL. 45 DAYS
```

8. The Date/Time/Battery Level Screen appears for a few seconds.

```
Sept/23/'03  
20:34  
BATTERY: ██████████
```

This screen displays the current date, time, and an indication of how much battery charge remains. If the battery icon is fully filled in black, then the batteries are at full charge.

9. If the GX-2003 experiences a sensor failure, a screen indicating which sensor failed displays. In the example below, the combustible % volume sensor has failed.

```
FAIL  
SENSOR  
< > <CH4 VOL>  
< > < > < >  
21:09 ██████████
```

If a one of the combustible sensors, LEL/ppm or % volume, fails, it is not possible to enter Bar Hole Mode. Press and release the

RESET SILENCE button to acknowledge the failure and return to the Mode Select Screen. Replace the failed sensor as soon as possible.

If the oxygen sensor fails, press and release the RESET SILENCE button to acknowledge the failure and continue to Bar Hole Mode. The gas reading for the oxygen sensor will be replaced by “XXX”. Replace the failed sensor as soon as possible.

If the CO or H₂S sensor is installed and fails, press and release the RESET SILENCE button to acknowledge the failure and continue to Bar Hole Mode.

10. The GX-2003 is now operating in Bar Hole Mode. The pump is off and the following screen appears.

CH4	0%LEL
OXY	20.9VOL%
ENTER:MEASURE	
DISP :PURGE	
B.H.MODE	21:09 

The methane and oxygen channels are displayed along with the time and battery charge level.

Performing a Demand Zero, Bar Hole Mode

Before using the GX-2003, it is recommended to set the fresh air readings for the target gasses by performing a demand zero. This will set the CH₄ channel to zero and the OXY channel to 20.9%.

1. Find a fresh-air environment. This is an environment free of toxic or combustible gasses and of normal oxygen content (20.9%).
2. Turn on the unit as described above in “Turning On the GX-2003, Bar Hole Mode”.
3. Press and hold the ▲AIR button. The pump will start and the display will indicate “FRESH AIR PURGE . . .” below the oxygen reading for a few seconds before indicating that a demand zero is taking place and prompting you to hold the ▲AIR button.
4. Continue to hold the ▲AIR button until the display prompts you to release the ▲AIR button. The GX-2003 will set the fresh air reading for the CH₄ and oxygen channels. Start up is complete and the unit is now ready for bar hole testing.

Bar Hole Testing

In bar hole mode, the you can initiate sampling for a fixed time period to monitor for methane and oxygen in a bar hole. The factory set time is 30 seconds. At the end of the sample period, the pump will shut off and the peak methane and minimum oxygen levels monitored during the sample period will be displayed. Bar Hole Mode also allows the you to initiate an air purge cycle to purge gas from the GX-2003 after a sample is taken. See “Setting the Bar Hole Measurement Time” on page 72 to change the bar hole sample time.

In a low-light environment, press and release the (SHIFT)▼ button to turn on the display backlight. Although the backlight will turn on when any button is pressed, other buttons may initiate an undesired operation sequence. See “Updating the LCD Back Light Time Setting” on page 71 to program backlight duration. If CONFIRMATION BEEP is turned on in the Setup Mode menu, the GX-2003 beeps once every 15 minutes to confirm that it’s operating.

Performing a Bar Hole Test

1. Start up the GX-2003 as described in “Start Up, Bar Hole Mode” on page 45.
2. Take the GX-2003 to the bar hole that will be tested.
3. Insert the probe into the bar hole and press and release the POWER/ENTER button. The pump will turn on and the sample period will begin with the sample period counting down in seconds in the lower right corner of the display above the battery icon. The CH4 channel will be displayed in %VOL and B.H. MODE will be flashing.

CH4	0%VOL
OXY	20.9VOL%
B.H.MODE	21:09  30

4. After 15 seconds of sampling, if the CH4 reading is less than 5 %VOL, the CH4 channel will automatically begin displaying in %LEL.

5. At the end of the sample period, the pump will shut off and the audible alarm will sound, then the peak methane reading and the minimum oxygen reading for the sample period will be displayed.

PCH4	0%LEL
EOXY	20.9VOL%
A	ENTER:MEASURE
K	DISP :PURGE
B.H.MODE	21:09 

6. If a high concentration of methane is encountered, a fresh air purge can be performed to purge the hose, probe and GX-2003 of gas before the next bar hole test. To perform a purge, do the following:

- Remove the probe from the barhole so the instrument will draw fresh air.
- Press and release the DISPLAY (ADJ) button. The display will now indicate “FRESH AIR PURGE . . .” below the oxygen reading and the purge time will begin counting down from 30 seconds in the lower right corner of the display above the battery icon.

CH4	0%VOL
OXY	20.9VOL%
FRESH AIR PURGE . . .	
	30
B.H.MODE	21:09 

- When the purge is complete, the screen will return to the initial Bar Hole Mode screen.

CH4	0%LEL
OXY	20.9VOL%
	ENTER:MEASURE
	DISP :PURGE
B.H.MODE	21:09 

7. If other bar holes will be tested, proceed to the next bar hole and repeat steps 3 - 6.
8. To cancel a bar hole measurement or fresh air purge that is in progress, press and release the DISPLAY(ADJ) button.
9. To exit Bar Hole Mode and return to the Mode Select Screen at any time, press and hold the (SHIFT)▼ button for 5 seconds.

Turning Off the GX-2003, Bar Hole Mode

1. Press and hold the POWER ENTER button.
2. The unit will initiate a bar hole measurement. Keep holding the POWER ENTER button. The buzzer will sound and the LCD back light will flash for about five seconds.
3. Release the button when GOODBYE appears on the display. When GOODBYE disappears and the backlight turns off, the unit is off.

Chapter 5: Using the GX-2003 in Leak Check Mode

Overview

This chapter explains how to operate the GX-2003 in Leak Check Mode. Leak Check Mode is used to pinpoint small leaks of combustible gas from valves, flanges, connections, and other potential leak points. When the GX-2003 is in Leak Check Mode, only the LEL/ppm combustible sensor is active.

If a GX-2003 is intended for tracking down leaks, it is shipped with Bar Hole Mode and Leak Check Mode enabled so that the operator must choose which operational mode to use when the unit is turned on (see “Turning LB Mode Display On or Off” on page 72).

Start Up, Leak Check Mode

This section explains how to start up the GX-2003 in Leak Check Mode and get it ready for operation.

NOTE: The battery drain is higher in Leak Check Mode than in Normal Mode or Bar Hole Mode. Extended operation in this mode will result in shorter battery life than specified in “Specifications” on page 9.

Turning On the GX-2003, Leak Check Mode

CAUTION: *If an oxygen, CO, or H₂S sensor is installed, these sensors will not be active while the GX-2003 is in Leak Check Mode.*

The following description of the GX-2003 start up sequence assumes that the following menu items in Setup Mode are turned on: USER/STATION ID, and CAL. TIME REMAINING. If either of these items is turned off, then the corresponding screen will not appear.

NOTE: In order for **BAR HOLE MODE** to appear as a selection in the Mode Select Screen in Step 3 below, the GX-2003 must have both a % volume combustible sensor and an LEL/PPM sensor installed. If a GX-2003 has only the LEL/PPM sensor installed, then **BAR HOLE MODE** will not appear as a choice as shown in Step 3 below and **NORMAL MODE** and **LEAK CHECK MODE** will be the only choices displayed.

1. Connect the tapered rubber nozzle or the sample hose to the GX-2003's quick connect inlet fitting.
2. If a sample hose is used, screw the probe onto the sample hose's threaded fitting.

NOTE: If a probe is used when using the GX-2003 in Leak Check Mode, use the standard probe, not the bar hole probe.

3. Press and briefly hold down the POWER/ENTER button. The Mode Select Screen displays.

```

>NORMAL MODE
BAR HOLE MODE
LEAK CHECK MODE

21:09 [Battery Icon] N
  
```

NOTE: If a “N” appears to the right of the battery icon, this indicates that a Ni-MH battery pack is being used instead of alkaline batteries.

4. The cursor will begin in front of Normal Mode and Normal Mode will flash dark and light indicating it is selected. Use the (SHIFT)▼button to move it in front of Leak Check Mode.
5. With Leak Check Mode selected, press and release the POWER/ENTER button to begin the Leak Check Mode startup sequence.

NOTE: If no button is pressed for 20 seconds, the unit will proceed into whichever mode has the cursor in front of it.

6. If USER/STATION ID is turned on (see page 62), the ID Screen displays for a few seconds.

```

USER ID
*****
STATION ID
*****
  
```

7. After the ID Screen, if CAL. TIME REMAINING is turned on, the screen that appears next depends on how CAL.EXPIRED ACTION is set in the Setup Mode Menu(page 62).
 - If the unit is due for calibration and CAL. EXPIRED ACTION is set to CONFIRM TO USE, then the following screen

displays.

CAL. DATE PAST
CAL. IS REQUIRED

The alarm LED's and buzzer will pulse several times and the vibrator will activate for a second. After this, press the RESET SILENCE button until you hear a beep to continue.

- If the unit is due for calibration and CAL. EXPIRED ACTION is set to CANNOT USE, then the following screen displays.

CAL. DATE PAST
NOT OPERATED

The GX-2003 cannot be used until a calibration has been performed by selecting AUTO CALIBRATION in Setup Mode Menu. See "Calibration Mode" on page 38 for calibration instructions.

- If calibration is not due or CAL EXPIRED ACTION is set to NO EFFECT, then the following screen appears for a few seconds indicating when the next calibration is due.

NEXT CAL. DATE
Dec/18/'03
TIME TO CAL. 45 DAYS

8. The Date/Time/Battery Level Screen appears for a few seconds.

Sept/23/'03
20:34
BATTERY: 

This screen displays the current date, time, and an indication of how much battery charge remains. If the battery icon is fully filled in black, then the batteries are at full charge.

9. If the GX-2003 experiences a sensor failure during start up, a screen indicating which sensor failed displays. In the example

below, the LEL/ppm sensor has failed.

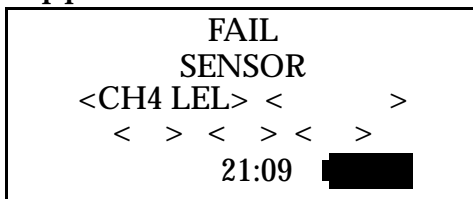

If the LEL/ppm sensor fails, it is not possible to enter Leak Check Mode. Press and release the RESET SILENCE button to acknowledge the failure and return to the Mode Select Screen. Replace the failed sensor as soon as possible.

If the % volume combustible, oxygen, CO, or H₂S sensor is installed and fails, press and release the RESET SILENCE button to acknowledge the failure and continue to Leak Check Mode. Replace the failed sensor as soon as possible.

10. The GX-2003 is now operating in Leak Check Mode. The pump is on and the following screen appears.

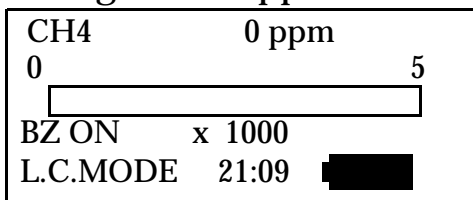

The methane channel is displayed along with the time and battery charge level. L.C. MODE in the lower left corner is flashing.

Performing a Demand Zero, Leak Check Mode

Before using the GX-2003, it is recommended to set the fresh air reading for the target gas by performing a demand zero. This will set the CH4 channel to zero.

1. Find a fresh-air environment. This is an environment free of toxic or combustible gasses and of normal oxygen content (20.9%).
2. Turn on the unit as described above in “Turning On the GX-2003, Leak Check Mode”.
3. Press and hold the ▲AIR button. The display prompts you to hold the ▲AIR button.
4. Continue to hold the ▲AIR button until the display prompts you to release the ▲AIR button. The GX-2003 will set the fresh air reading for the CH4 channel. Start up is complete and the unit is now ready for monitoring.

Leak Testing

In Leak Check Mode, the GX-2003 only displays combustible gas readings, and the readings are displayed in 100 ppm increments up to 5,000 ppm. The readings are displayed in both numerical and bar graph form. As the gas concentration increases from 0 ppm, the alarm LEDs begin to blink in unison with the buzzer's pulsing. The blinking/pulsing rate increases as the gas reading increases. If desired the buzzer can be turned off in Leak Check Mode.

In a low-light environment, press and release any of the buttons to turn on the display backlight. See "Updating the LCD Back Light Time Setting" on page 71 to program backlight duration. If CONFIRMATION BEEP is turned on in the Setup Mode menu, the GX-2003 beeps once every 15 minutes to confirm that it's operating.

Locating a Leak

1. Start up the GX-2003 as described above in "Start Up, Leak Check Mode" on page 52.
2. Move the probe tip or tapered nozzle tip back and forth along the area where a leak is suspected.
3. Observe the display reading. If the gas level increases, the numerical reading will increase, the bar graph level will increase to the right, and the beeping and buzzer pulsing frequency will increase.
4. Use the increasing and decreasing of the reading to locate the leak point.
5. To exit Leak Check Mode and return to the Mode Select Screen at any time, press and hold the (SHIFT)▼ button for 5 seconds.

Turning the Buzzer On and Off in Leak Check Mode

The alarm buzzer can be turned off and on when the GX-2003 is in Leak Check Mode. This setting only applies to Leak Check Mode and does not affect buzzer operation in Normal or Bar Hole Mode. The buzzer setting is displayed in the lower left corner as **BZ ON** when the buzzer is on or **BZ OFF** when the buzzer is off. When the GX-2003 is turned on, the buzzer is always set to **BZ ON** in Leak Check Mode. If the buzzer is turned off, then it will remain off in Leak Check Mode even if you enter Normal Mode or Bar Hole Mode and return to Leak Check Mode unless it is manually turned on or the unit is turned off and on again.

To turn the buzzer off or on while in Leak Check Mode:

1. Press and hold the DISPLAY(ADJ) button for 3 seconds.
2. Release the button when the buzzer setting in the lower left corner changes.

Turning Off the GX-2003, Leak Check Mode

1. Press and hold the POWER ENTER button.
2. The buzzer will sound and the LCD back light will flash for about five seconds.
3. Release the button when GOODBYE appears on the display. When GOODBYE disappears and the backlight turns off, the unit is off.

Chapter 6: Setup Mode

Overview

This chapter describes the GX-2003 in Setup Mode. In Setup Mode, you can:

- update alarm point settings
- turn the lunch break function on or off
- update the alarm latching setting
- update the alarm silence setting
- turn the confirmation beep on or off
- update the data logging interval time setting
- update the data logger overwrite setting
- update the date and time
- update the calibration interval setting
- turn the calibration time remaining function on or off
- update the calibration expired action setting
- adjust the display contrast
- update the GX-2003's serial number
- turn the user ID/station ID function on or off
- perform an auto calibration
- perform a single calibration
- update the LCD back light time setting
- turn the password function on or off
- turn bar hole and leak check modes on or off
- set the bar hole measurement time

The GX-2003 is factory-set to suit most applications. Update settings in Setup Mode only if required for your specific application.

Tips for Using Setup Mode

- When in the main menu, the cursor (>) will flash in front of a menu item indicating that the item is selected.
- Use (SHIFT)▼ to scroll down through the main menu and submenus, and to lower values or change the setting in a specific option.
- Use ▲AIR to scroll up through the main menu and submenus, and to raise values or change the setting in a specific option.
- Use the POWER ENTER button to enter a selected menu item, and to enter and save settings during programming.
- An adjustable parameter that is flashing can be adjusted with the ▲AIR and (SHIFT)▼ buttons.
- Press the DISPLAY (ADJ) button while entering or updating parameters to exit the screen without saving any changes.

Using Setup Mode

WARNING: The GX-2003 is not in operation as a gas detector while in Setup Mode. Although it will respond to gas in parts of AUTO CALIBRATION and SINGLE CALIBRATION, there are no alarm indications.

1. Take the GX-2003 to a non-hazardous location, and turn it off if it is on.
2. Press and hold down the ▲AIR and (SHIFT)▼ buttons, then press and hold the POWER/ENTER button. When you hear a beep, release the buttons. If the unit prompts you for the password, enter it by using the ▲AIR and (SHIFT)▼ buttons to select each password number and then pressing and releasing POWER ENTER to enter it and move on to the next one. The main menu displays. It displays four menu items at a time.

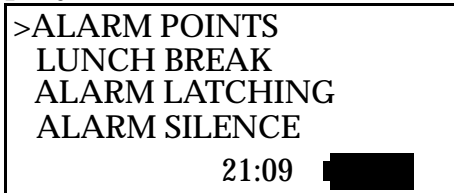

```
>ALARM POINTS
LUNCH BREAK
ALARM LATCHING
ALARM SILENCE
21:09 [Battery Icon]
```

3. Use the ▲AIR or (SHIFT)▼ button to move the cursor up and down the menu items and to view additional menu items.

Updating the Alarm Point Settings

This menu item allows you to update one or more alarm points (the reading at which the GX-2003 recognizes the alarm condition).

1. From the main menu, place the cursor next to the **ALARM POINTS** menu item. Press and release the POWER ENTER button. All detection channels are displayed.

```
>CH4
OXY
H2S
CO
21:09 [REDACTED] N
```

2. Move the cursor next to the channel of the alarm point you want to update. Press and release the POWER ENTER button. The channel's set alarm screen displays for low alarm (in this example for the combustible gas channel).

```
SET ALARM
<CH4> %LEL
LOW ALARM
10% LEL
21:09 [REDACTED]
```

NOTE: The GX-2003 displays the set alarm screens for each channel in the following sequence: low alarm, high alarm, STEL alarm (toxics only), and TWA alarm (toxics only).

If this is the alarm you want to update, continue with step 3. If not, continue pressing the POWER ENTER button until the correct set alarm screen displays, then continue with step 3.

3. Use the ▲ AIR and (SHIFT) ▼ buttons to set the alarm point to the desired setting. Keep the following in mind:
 - The low alarm cannot be set higher than the high alarm and the high alarm cannot be set lower than the low alarm.
 - Any alarm setting can be turned off by adjusting it to its lowest setting. The setting will be displayed as **OFF**. To turn off a high alarm, the low alarm must also be turned off.
 - The oxygen low alarm is a decreasing alarm. All other gas alarms are increasing alarms.

NOTE: If you want to exit this screen without saving any change to the alarm point, press the DISPLAY (ADJ) button

4. Press and release the POWER ENTER button to save the new alarm point and move to the next set alarm screen.
5. Repeat step 3 and 4 to update additional alarms while in the desired set alarm screen.
6. Press and release the POWER/ENTER button repeatedly until you return to the screen that displays all the detection channels.
7. Repeat steps 2 through 6 until all desired alarms are updated.
8. To exit **ALARM POINTS**, use the (SHIFT)▼ button to move the cursor to the last menu item on the screen, then press and release the (SHIFT)▼ button again. The **ESCAPE** message displays.
9. Press and release the POWER ENTER button to save the settings and return to the main menu.

Updating the Lunch Break Setting

With **LUNCH BREAK** set to **OFF** (factory setting), the GX-2003 automatically starts new TWA and PEAK reading collection and resets the time in operation at start up.

With **LUNCH BREAK** set to **ON**, the Resume Datalog Screen displays during start up. From this screen, you can choose to continue accumulating TWA and PEAK readings and the time in operation from the last time the GX-2003 was used or start collecting new readings.

1. From the main menu, place the cursor next to the **LUNCH BREAK** menu item. Press and release the POWER ENTER button.

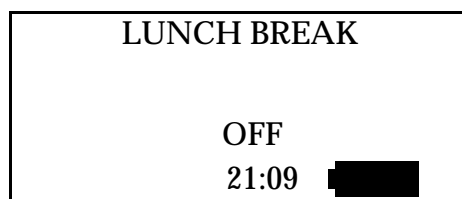

2. Use the ▲AIR or (SHIFT)▼ button to display the desired setting.
3. Press and release the POWER/ENTER button to save the setting and return to the main menu.

Updating the Alarm Latching Setting

With **ALARM LATCHING** set to **ON** (factory setting), the GX-2003 remains in alarm condition until the alarm condition passes *and* the **RESET SILENCE** is pressed.

With **Alarm Latching** set to **OFF**, the GX-2003 automatically resets an alarm when the alarm condition passes.

1. From the main menu, place the cursor next to the **ALARM LATCHING** menu item. Press and release the **POWER ENTER** button.

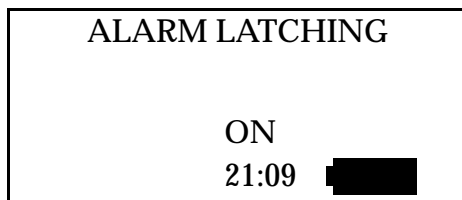

2. Use the **▲AIR** or **(SHIFT) ▼** button to display the desired setting.
3. Press and release the **POWER ENTER** button to save the setting and return to the main menu.

Updating the Alarm Silence Setting

With **ALARM SILENCE** set to **ON** (factory setting), pressing and releasing the **RESET SILENCE** button silences the buzzer when the GX-2003 is in alarm. The LED's continue to flash, and the display continues to show the level of alarm. When the gas concentration falls below the low alarm level, pressing and releasing the **RESET SILENCE** button turns off the LED's and removes the **ALM1** message.

With **ALARM SILENCE** set to **OFF**, you cannot silence the buzzer.

1. From the main menu, place the cursor next to the **ALARM SILENCE** menu item. Press and release the **POWER ENTER** button.

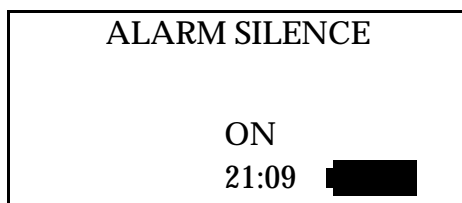

2. Use the **▲AIR** or **(SHIFT) ▼** button to display the desired setting.
3. Press and release the **POWER ENTER** button to save the setting and return to the main menu.

Updating the Confirmation Beep Setting

With **CONFIRMATION BEEP** set to **ON**, the GX-2003 beeps once every 15 minutes to verify that it is operating.

With **CONFIRMATION BEEP** set to **OFF** (factory setting), the GX-2003 does not sound a confirmation beep.

1. From the main menu, place the cursor next to the **CONFIRMATION BEEP** menu item. Press and release the **POWER ENTER** button.

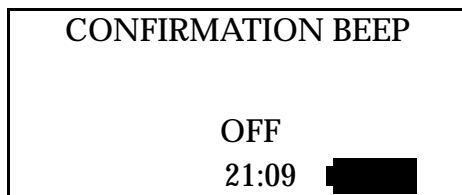

2. Use the **▲AIR** or **(SHIFT)▼** button to display the desired setting.
3. Press and release the **POWER ENTER** button to save the setting and return to the main menu.

Updating the Interval Time Setting

This setting indicates how often the GX-2003 records readings into the data logger. The following interval times can be selected: 10 minutes; 5 minutes; 3 minutes; 1 minute; 30 seconds; 20 seconds; 10 seconds. The factory setting is 5 minutes.

1. From the main menu, place the cursor next to the **INTERVAL TIME** menu item. Press and release the **POWER ENTER** button.

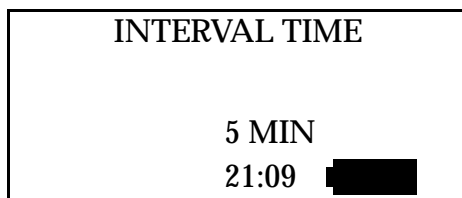

2. Use the **▲AIR** or **(SHIFT)▼** buttons to display the desired setting.
3. Press and release the **POWER ENTER** button to **SAVE** the setting and return to the main menu.

Updating the Datalog Overwrite Setting

With **DATALOG OVERWRITE** set to **ON** (factory setting), the GX-2003 writes over the oldest data with new data when the data logger memory is full.

With **DATALOG OVERWRITE** set to **OFF**, the GX-2003 stops saving data to the data logger when the data logger memory is full.

1. From the main menu, place the cursor next to the **DATALOG OVERWRITE** menu item. Press and release the POWER ENTER button.

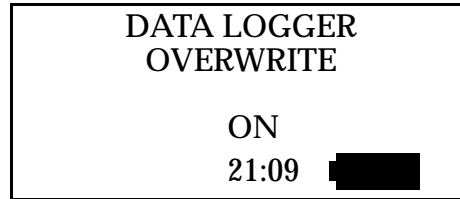

2. Use the ▲AIR or (SHIFT)▼ button to display the desired setting.
3. Press and release the POWER/ENTER button to save the setting and return to the main menu.

Updating the Date and Time Settings

1. From the main menu, place the cursor next to the **DATE/TIME** menu item. Press and release the POWER ENTER button. The date and time will be displayed with the year flashing.

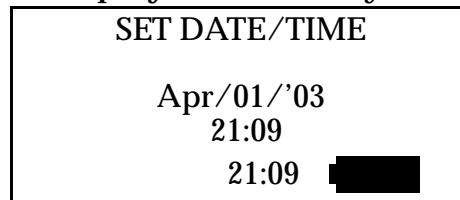

2. Use the ▲AIR or (SHIFT)▼ button to display the desired year.
3. Press and release the POWER ENTER button to save the setting. The month setting flashes.
4. Repeat steps 2 and 3 to enter the month, day, hours, and minutes settings. The main menu displays after you enter the minutes setting.

Updating the Calibration Interval

This setting defines the amount of time between calibrations. The minimum setting is 1 day and the maximum setting is 255 days. The factory setting is 90 days.

1. From the main menu, place the cursor next to the **CAL. INTERVAL** menu item. Press and release the POWER ENTER button.

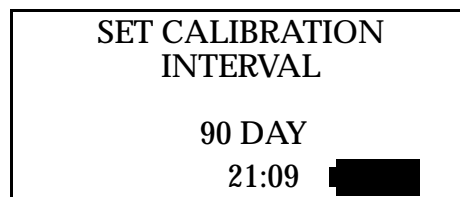

2. Use the ▲AIR or (SHIFT)▼ button to display the desired setting.

Tip: Press and hold the ▲AIR or (SHIFT)▼ button to rapidly scroll through the settings.

3. Press and release the POWER ENTER button to save the setting and return to the main menu.

Updating the Calibration Time Remaining Setting

With **CAL. TIME REMAINING** set to **ON** (factory setting), the GX-2003 will give an indication at start up if it is due for calibration. The type of indication will depend on the **CAL. EXPIRED ACTION** setting (see below).

1. From the main menu, place the cursor next to the **CAL. TIME REMAINING** menu item. Press and release the POWER ENTER button.

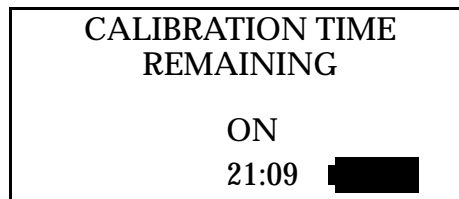

2. Use the ▲AIR or (SHIFT)▼ button to display the desired setting.

3. Press and release the POWER ENTER button to save the setting and return to the main menu.

Updating the Calibration Expired Action Setting

This item defines what indication is given during start up when calibration is due and **CAL. TIME REMAINING** is set to **ON**.

With **CAL. EXPIRED ACTION** set to **CONFIRM TO USE** (factory setting), the GX-2003 will give an indication at start up if calibration is due and require the user to press the RESET SILENCE button to continue.

With **CAL. EXPIRED ACTION** set to **CANNOT USE**, if the unit is due for calibration the GX-2003 will give an indication at start up that calibration is due and the unit cannot be used until it is calibrated.

With this setting, it is necessary to calibrate the instrument from the Setup Mode if calibration is not performed before it is due. See “Calibrating Using Auto Calibration” on page 67 and “Calibrating Using Single Calibration” on page 69 for instructions.

With **CAL. EXPIRED ACTION** set to **NO EFFECT**, no confirmation during startup or calibration is required to use the GX-2003.

1. From the main menu, place the cursor next to the **CAL. EXPIRED ACTION** menu item. Press and release the POWER ENTER button.

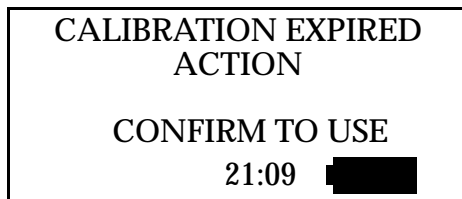

2. Use the ▲AIR or (SHIFT) ▼ button to display the desired setting.
3. Press and release the POWER ENTER button to save the setting and return to the main menu.

Updating the LCD Contrast Setting

NOTE: The LCD contrast setting can also be adjusted in Calibration Mode. See “Adjusting the LCD Contrast” on page 44.

The contrast setting controls the LCD contrast. Select the setting so the characters on the display are easy to see. It can be set from 0 to 15. The higher the setting, the darker the characters and LCD background.

1. From the main menu, place the cursor next to the **CONTRAST** menu item. Press and release the POWER ENTER button.

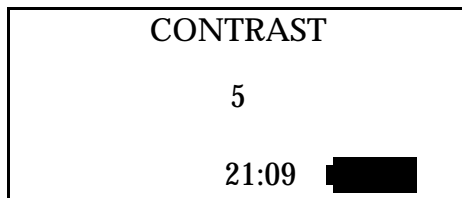

2. Use the ▲AIR or (SHIFT) ▼ button to adjust the setting until the characters on the LCD are easy to see.
3. Press and release the POWER ENTER button to save the setting and return to the main menu.

Updating the GX-2003's Serial Number

Every GX-2003 is factory programmed with a unique serial number that matches the serial number on the serial number label. Use the following procedure if you wish to change the serial number.

1. From the main menu, place the cursor next to the **SERIAL No.** menu item. Press and release the POWER ENTER button. The first character of the serial number is flashing indicating it can be changed.

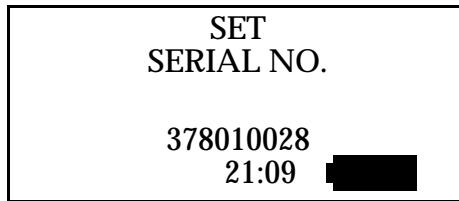

2. Use the ▲AIR or (SHIFT) ▼ button to display the desired character, then press and release the POWER/ENTER button to enter the character. The next character flashes.
3. Repeat step 2 to enter the remaining characters. The serial number is saved and the main menu displays after you enter the last character.

Turning the User/Station ID Function On or Off

With **USER/STATION ID** set to **ON**, the ID Screen displays during start up and in Display Mode. The ID's can be updated in Display Mode

With **USER/STATION ID** set to **OFF** (factory setting), the ID Screen does not display during start up or in Display Mode.

1. From the main menu, place the cursor next to the **USER/STATION ID** menu item. Press and release the POWER ENTER button.

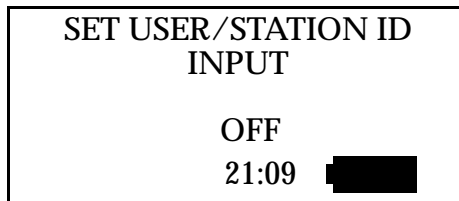

2. Use the ▲AIR or (SHIFT) ▼ button to display the desired setting.
3. Press and release the POWER ENTER button to save the setting and return to the main menu.

Calibrating Using Auto Calibration

If the **CAL. EXPIRED ACTION** is set to **CANNOT USE** and calibration becomes due, then the unit must be calibrated using this menu item and/or the next menu item, **SINGLE CALIBRATION** because it will not be possible to enter normal operation. See "Calibration Supplies and Equipment" on page 38 for the items you will need to perform a calibration.

1. Install the demand flow regulator onto the calibration cylinder.
2. Connect the sample tubing to the demand flow regulator.

3. Install the hose and probe to the GX-2003.
4. From the main menu, place the cursor next to the **AUTO CALIBRATION** menu item. Press and release the POWER ENTER button to display the calibration values screen.

C CH4	50%LEL
A OXY	12.0VOL%
L H2S	25.0ppm
. CO	50ppm
	21:09 

The gas concentrations displayed in the calibration values screen must match the gas concentrations listed on the 4-gas calibration cylinder. If *all* concentrations match, go to step 9. If *one or more* concentrations do not match, continue with step 5.

5. To adjust the values on the screen, hold down the (SHIFT)▼ button, then press the DISPLAY(ADJ) button and release both. The CH4 calibration value begins to flash.
6. If necessary, use the ▲AIR and (SHIFT)▼ buttons to set the correct combustible gas value.
7. Press and release the POWER ENTER button to enter the new setting. The OXY calibration value begins to flash.
8. Repeat steps 6 and 7 to set the correct values for the remaining channels. After the last channel is set, you return to the calibration values screen and the values are no longer flashing.

NOTE: The RKI Four Gas Cylinder typically contains 12% O₂ by volume. Be sure to set the “OXY” reading to agree with the concentration listed on the cylinder’s label, not zero.

9. With the calibration values screen displayed, press the POWER/ENTER button. **CAL.** along the left side of the LCD begins to flash and the current gas readings are displayed.

C CH4	0%LEL
A OXY	20.9VOL%
L H2S	0.0ppm
. CO	0ppm
	21:09 

10. Connect the tubing from the demand flow regulator to the rigid tube on the probe. Allow the gas to flow for one minute.
11. Press and release the POWER/ENTER button to set the calibration to the programmed values.

If all channels passed calibration, **AUTO CALIBRATION PASS** displays, then the calibration main Setup menu displays.

If any of the sensors cannot calibrate to the proper value, **FAIL PUSH AIR KEY** displays and the GX-2003 lists the sensor(s) that failed to calibrate. In the example below, the OXY and H2S channels failed calibration. The other sensors calibrated normally.

```
FAIL
PUSH AIR KEY
< > < >
<O2> < > <CO>
21:09 [REDACTED]
```

The buzzer, vibrator, and alarm lights activate. Press and hold the **▲AIR** button for a few seconds to reset the alarm and return to the main Setup menu. Attempt to calibrate again. If the failure continues, investigate the cause. See “Troubleshooting” on page 74.

12. Disconnect the tubing from the probe.
13. Unscrew the demand flow regulator from the calibration cylinder.

Calibrating Using Single Calibration

If the **CAL. EXPIRED ACTION** is set to **CANNOT USE** and calibration becomes due, then the unit must be calibrated using this menu item and/or the previous menu item, **AUTO CALIBRATION** because it will not be possible to enter normal operation. See “Calibration Supplies and Equipment” on page 38 for the items you will need to perform a calibration.

1. Install the demand flow regulator onto the calibration cylinder.
2. Connect the sample tubing to the demand flow regulator.
3. Install the hose and probe to the GX-2003.
4. From the main menu, place the cursor next to the **SINGLE CALIBRATION** menu item. Press and release the **POWER/ENTER** button to display the single calibration menu.

```
>CH4 (%LEL)
CH4 (VOL%)
OXY
H2S
21:09 [REDACTED]
```

NOTE: To display the CO sensor, use the (SHIFT)▼ button to move the cursor to the bottom of the screen and then press it again to advance to the next screen.

5. Use the ▲AIR or (SHIFT)▼ button to place the cursor next to the sensor you want to calibrate (in this example the combustible gas %LEL sensor).
6. Press and release the POWER/ENTER button. The single calibration screen displays for the sensor you selected. The gas reading flashes.

CH4 CALIBRATION
0% LEL
APPLY GAS
ADJ/ENTER
21:09 ██████

7. Connect the tubing from the demand flow regulator to the rigid tube on the probe. Allow the calibration gas to flow for one minute.
8. If necessary, use the ▲AIR and (SHIFT)▼ buttons to adjust the reading to match the concentration listed on the calibration cylinder.
9. Press and release the POWER ENTER button to save the span value. The LCD will indicate that the calibration has ended, then the single calibration menu displays.
10. Disconnect the tubing from the GX-2003's probe.
11. Repeat steps 5 through 10 for any other channels you want to calibrate. Make sure you use an appropriate calibration cylinder for each channel.

CAUTION: *When calibrating the oxygen channel, verify the concentration of oxygen listed on the cylinder's label. For oxygen-free samples (100% nitrogen for example), set the oxygen zero setting to 0.0%.*

12. After the last channel is calibrated, disconnect the calibration tubing from the probe, then unscrew the demand flow regulator from the calibration cylinder.
13. With the Single Calibration menu displayed, press the (SHIFT)▼ button until the cursor is next to the **ESCAPE** menu item.
14. Press and release the POWER ENTER button to return to the main Setup menu.

Updating the LCD Back Light Time Setting

This setting indicates the length of time the LCD illuminates when you press any button. The minimum setting is 0 seconds; the maximum setting is 60 seconds. The factory setting is 30 seconds.

1. From the main menu, place the cursor next to the **LCD BACK LIGHT TIME** menu item. Press and release the POWER ENTER button.

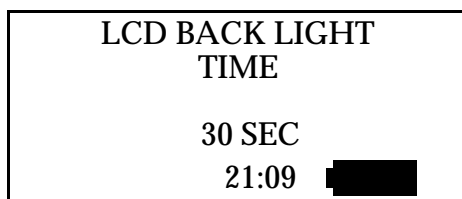

2. Use the **▲AIR** and **(SHIFT)▼** buttons to display the desired setting.
3. Press and release the POWER ENTER button to save the setting and return to the main menu.

Turning the Password Function On or Off

With **PASSWORD ON/OFF** set to **ON**, the GX-2003 prompts you for a password when you enter Calibration Mode or Setup Mode.

With **PASSWORD ON/OFF** set to **OFF** (factory setting), no password is required to enter Calibration Mode or Setup Mode.

1. From the main menu, place the cursor in front of the **PASSWORD ON/OFF** menu item. Press and release the POWER ENTER button.

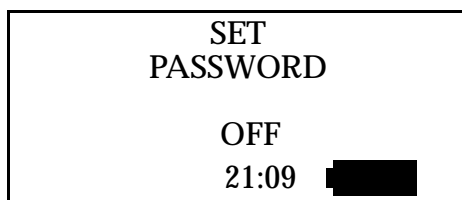

2. Use the **▲AIR** or **(SHIFT)▼** button to display the desired setting.
3. If you selected **OFF**, press and release the POWER ENTER button to save the setting and return to the main menu.
If you selected **ON**, press and release the POWER ENTER button. **ON** is replaced by four characters with the first character being a flashing 0 and the rest asterisks (*).
4. Use the **▲AIR** or **(SHIFT)▼** button to select a number from 0 to 9.
5. Press and release the POWER ENTER button to enter the selection and advance to the next character.

- Repeat steps 4 and 5 to select the remaining characters. When you press and release the POWER ENTER button to enter the last number, the password is saved and you return to the main menu.

Turning LB Mode Display On or Off

With **LB MODE DISPLAY** set to **ON**, the Mode Select Screen appears when the unit is turned on.

With **LB MODE DISPLAY** set to **OFF**, the Mode Select Screen does not appear when the unit is turned on and the unit goes into Normal Mode after the start up sequence.

This setting is factory set to **OFF** when a unit is shipped unless the instrument is ordered for bar hole measurement or leak checking use.

- From the main menu, place the cursor next to the **SET LB MODE DISPLAY** menu item. Press and release the POWER ENTER button.

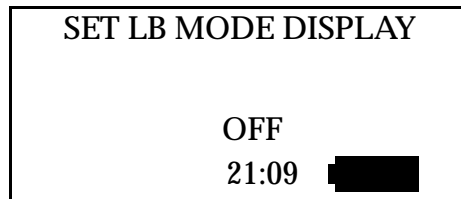

- Use the ▲AIR or (SHIFT)▼ button to display the desired setting.
- Press and release the POWER/ENTER button to save the setting and return to the main menu.

Setting the Bar Hole Measurement Time

This setting indicates the length of time the unit will sample when a bar hole measurement is initiated in Bar Hole Mode. It can be set to 30 (factory set), 45, or 60 seconds.

- From the main menu, place the cursor next to the **B.H. MEASURE TIME** menu item. Press and release the POWER ENTER button.

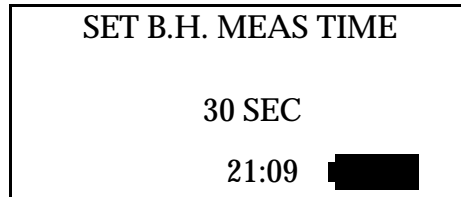

- Use the ▲AIR or (SHIFT)▼ button to display the desired setting.
- Press and release the POWER ENTER button to save the setting and return to the main menu.

Exiting Setup Mode

1. From the main menu, place the cursor in front of the **START MEASUREMENT** menu item. Press and release the **POWER ENTER** button.
2. The unit will begin its start up sequence.

Chapter 7: Maintenance

Overview

This chapter describes troubleshooting procedures for the GX-2003. It also includes procedures for recharging the battery pack and replacing various consumable parts.

WARNING: RKI Instruments, Inc. recommends that service, calibration, and repair of RKI instruments be performed by personnel properly trained for this work. Replacing sensors and other parts with original equipment does not affect the intrinsic safety of the instrument.

Troubleshooting

The troubleshooting table describes error messages, symptoms, probable causes, and recommended action for problems you may encounter with the GX-2003.

Table 6: Troubleshooting the GX-2003

Symptoms	Probable Causes	Recommended Action
<ul style="list-style-type: none">The LCD is blank.	<ul style="list-style-type: none">The unit may have been turned off.The alkaline batteries may need to be replaced or the Ni-MH battery pack recharged.	<ol style="list-style-type: none">To turn on the unit, press and briefly hold the POWER ENTER button.If the unit does not turn on, replace the alkaline batteries or recharge the Ni-MH battery pack.If the difficulties continue, contact RKI Instruments, Inc. for further instruction.
<ul style="list-style-type: none">Display indicates "Circuit Trouble" during startup.	<ul style="list-style-type: none">A circuit fault has occurred on one of the PCB's.	<ul style="list-style-type: none">Contact RKI Instruments, Inc. for further instruction.
<ul style="list-style-type: none">The LCD shows abnormally high or low readings but other gas detection instruments do not.	<ul style="list-style-type: none">The GX-2003 may need to be recalibrated.The sensor for the affected channel(s) may need replacement.	<ol style="list-style-type: none">Recalibrate the unit.If the difficulties continue, replace the sensor for the affected channel(s) and calibrate the affected channel(s).If the difficulties continue, contact RKI Instruments for further instruction.

Table 6: Troubleshooting the GX-2003

Symptoms	Probable Causes	Recommended Action
<ul style="list-style-type: none"> • The unit indicates flow failure and does not recover when RESET SILENCE is pressed and released. 	<ul style="list-style-type: none"> • The cotton filter in the probe or filter holder is dirty and clogged. • The sample hose has a kink or obstruction. • The hydrophobic filter disks or wire mesh disk are dirty and clogged • The pump is malfunctioning. 	<ol style="list-style-type: none"> 1. Change the cotton filter in the probe or filter holder. 2. Inspect the sample hose for kinks or obstructions and replace if necessary. 3. Inspect the hydrophobic filter disks and the wire mesh disk and replace if necessary. 4. If difficulties continue, contact RKI Instruments for further instruction.
<ul style="list-style-type: none"> • Auto calibration fails or unable to set the response readings during single calibration. 	<ul style="list-style-type: none"> • The auto calibration values may not match the cylinder gas concentrations. (auto calibration only) • The CO filter is saturated. • The sample gas is not reaching the sensor because of a bad connection • The calibration cylinder may be out of gas or is outdated. • The sensor for the affected channel(s) may need replacement. 	<ol style="list-style-type: none"> 1. Check all calibration tubing for leaks or for any bad connections. 2. Make sure the GX-2003 has been properly set up for calibration. 3. Change the CO filter. 4. Verify that the calibration cylinder contains an adequate supply of fresh test sample. 5. If the fail condition continues, replace the sensor(s). 6. If the difficulties continue, contact RKI Instruments, Inc. for further instruction.

Replacing or Recharging the Batteries

WARNING: To prevent ignition of a hazardous atmosphere, batteries must only be changed or charged in an area known to be nonhazardous.

Replace or charge the batteries when the battery icon indicates that the unit is in low battery warning. When in low battery warning, only half of one battery level indication bar is displayed in the battery icon on the LCD, and this icon will be flashing.

Replacing Alkaline Batteries or Ni-MH Battery Pack

NOTE: Use Procell PC 1500 alkaline batteries, Duracell MN 1500 alkaline batteries, or RKI Instruments Ni-MH battery pack 49-1606RK to maintain the CSA classification of the GX-2003. Use of other batteries or mixing alkaline and rechargeable batteries will void the CSA classification and may void the warranty

1. Turn off the GX-2003.

WARNING: Do not remove the batteries or battery pack while the GX-2003 is on.

2. Turn the battery cover release knob counterclockwise, remove the battery cover, and lay it aside.
3. Carefully remove the old alkaline batteries or rechargeable battery pack. To remove the battery pack, pull up on the tab at the bottom of the pack where "PULL" is molded into the plastic near the tab. Verify that the battery compartment and electrical contacts are clean.
4. Carefully install the new AA alkaline batteries or rechargeable battery pack.

For alkaline batteries, follow the battery diagram inside the battery compartment.

For a battery pack, match the molded polarity symbols in the corners of the pack with the diagram inside the battery compartment. Insert the end of the pack with the "-" symbol into the compartment first and then push it against the battery springs

while pushing down the other end to install it into the compartment.

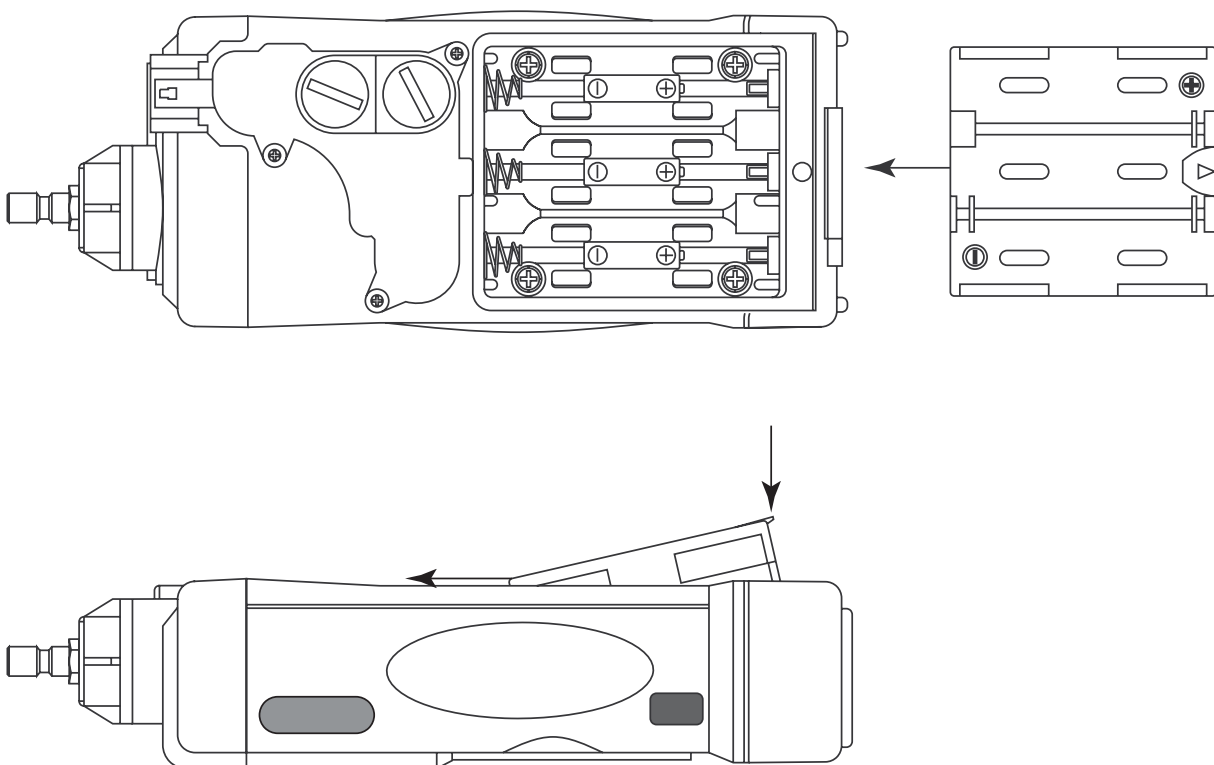

Figure 6: Installing the Battery Pack

5. Reinstall the battery cover and turn the battery cover release knob clockwise to lock the cover in place.

Recharging the Battery Pack in the Instrument

CAUTION: *To be used only with Ni-MH battery pack p/n 49-1606RK. Charge only with RKI charger model BC-2003, p/n 49-2160RK, or RKI charger model BC-2003DC, p/n 49-2161RK. Use of other rechargeable batteries or chargers or charging of other rechargeable batteries in the GX-2003 will void the warranty.*

1. Plug the power cord of the optional battery charging station into an AC outlet.
2. Make sure the GX-2003 is off.
3. Place the GX-2003 into the battery charging station as shown in Figure 7 below so that the metal contacts on the bottom of the unit come into contact with the metal contacts in the bottom of the holder in the charging station. When proper contact has been made, the red LED on the charging station will turn on.

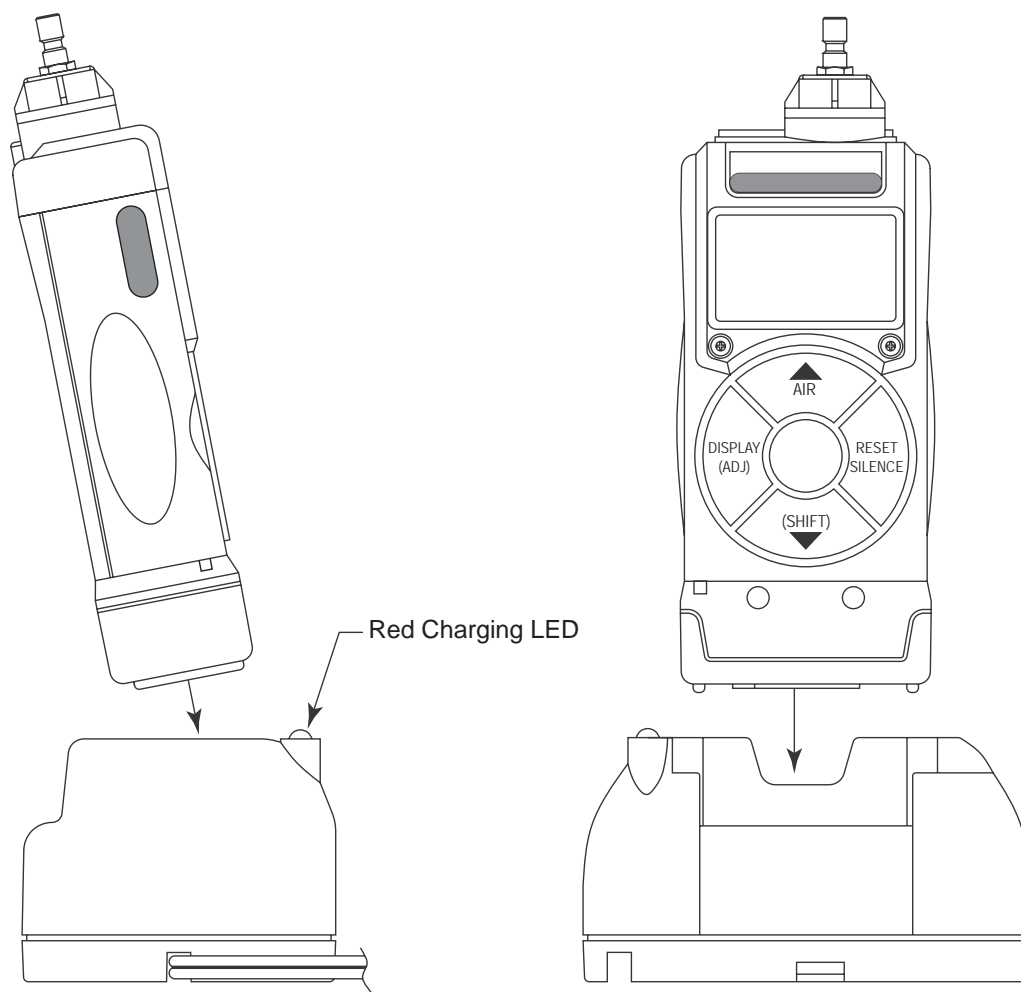

Figure 7: Putting the GX-2003 into the Charging Station

4. When a full charge has been reached, approximately 90 minutes, the red LED on the charging station will turn off. Remove the GX-2003 from the charging station and unplug the charging station's power cord from the AC outlet.

Recharging the Battery Pack Out of the Instrument

The battery pack may be charged using the charging station while it is out of the GX-2003. This is useful if spare battery packs are kept in case the pack in the GX-2003 needs to be charged, but the unit must be used immediately. In this case, a spare charged pack can be installed in the GX-2003 and the dead pack charged in the charging station.

1. Plug the power cord of the optional battery charging station into an AC outlet.

2. Insert the battery pack into the charging station as shown in Figure 8 below so that the metal contacts on the ends of the battery pack come into contact with the metal contacts in the charging station. When proper contact has been made, the red LED on the charging station will turn on.

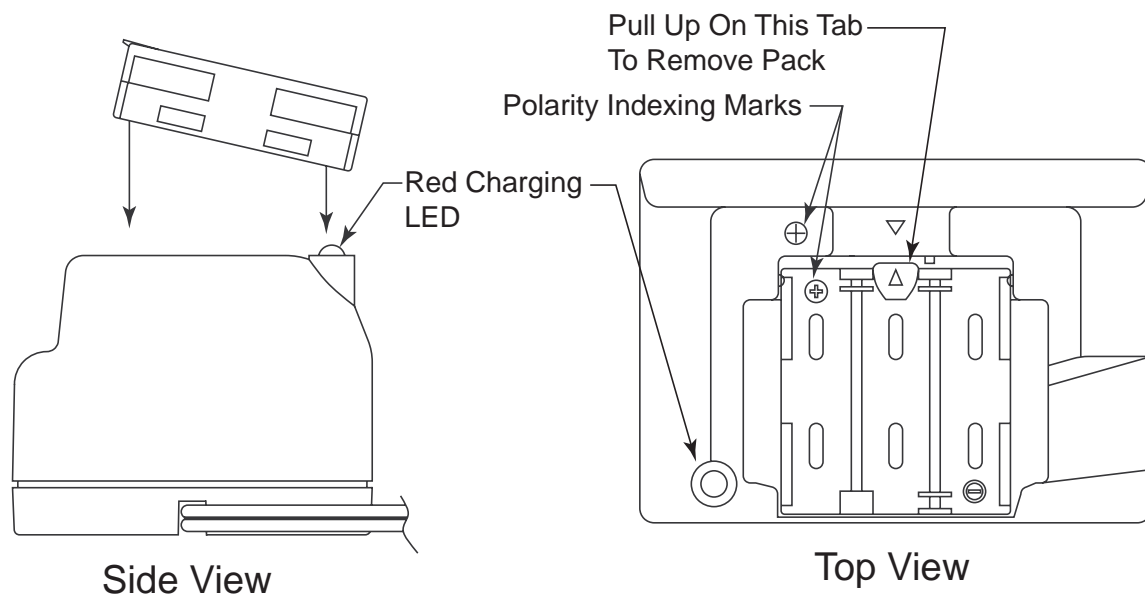

Figure 8: Putting the Battery Pack into the Charging Station

3. When a full charge has been reached, approximately 90 minutes, the red LED on the charging station will turn off. Remove the battery pack from the charging station by lifting up on the tab with the arrowhead on it and unplug the charging station's power cord from the AC outlet.

Replacing the HC and CO Filters

1. Verify that the GX-2003 is off.
2. Use a coin to unscrew the plastic filter retainer from the flow chamber on the back of the GX-2003. The HC filter is in the position closer to the exhaust and has a yellow label around its position. The CO filter is below the HC filter and has a red label around its position.
3. If the filter does not come out with the filter retainer, carefully remove it from the flow chamber.
4. Discard the old filter and snap the colored side (yellow for HC and red for CO) of the new filter into the filter retainer.

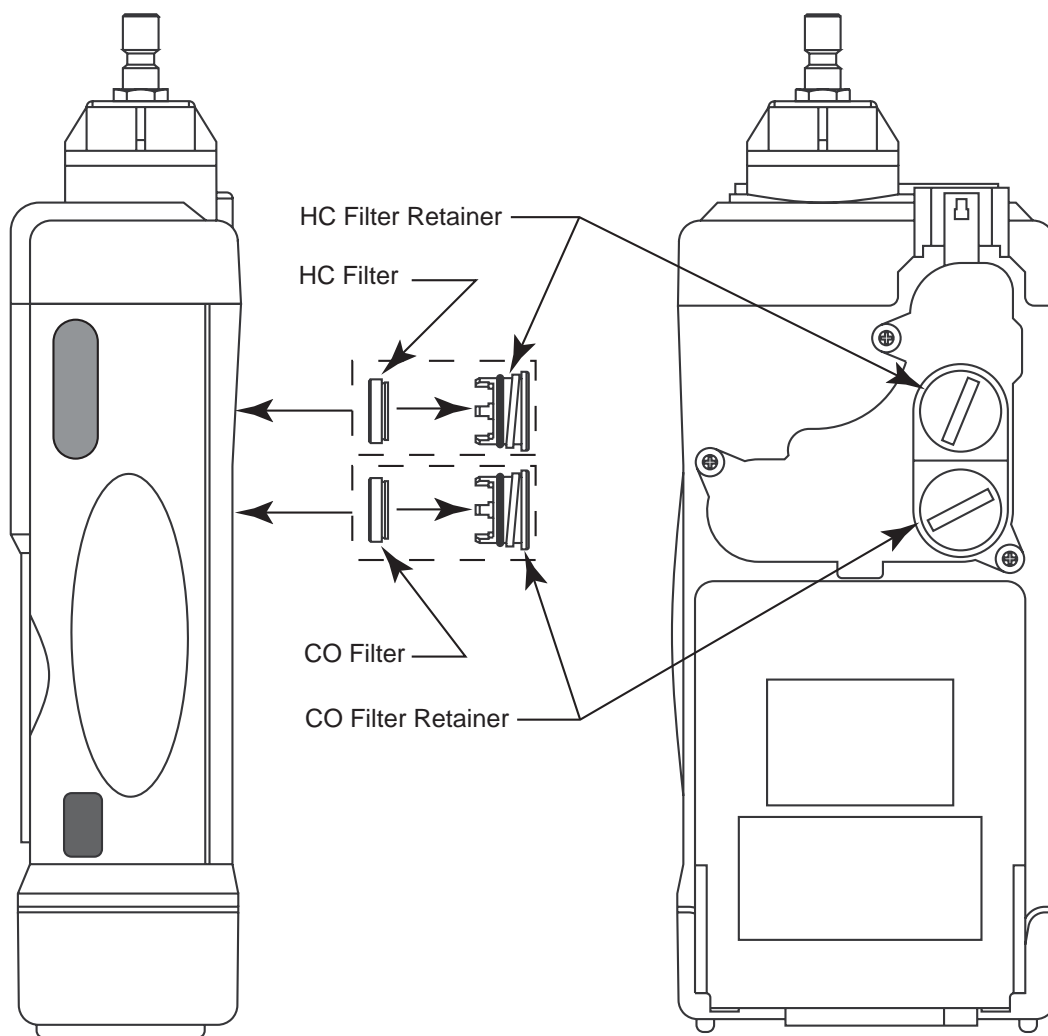

Figure 9: Replacing the CO and HC Filters

5. Carefully screw the filter retainer with the filter back into the correct position in the flow chamber.

Replacing a Sensor

1. Verify that the Model GX-2003 is off.
2. Unscrew and remove the three screws that secure the flow chamber to the back of the GX-2003.
3. Gently pull on the exhaust to remove the flow chamber from the case and expose the sensors.
4. Remove the sensor from its socket.
5. Carefully insert the replacement sensor in the correct socket.

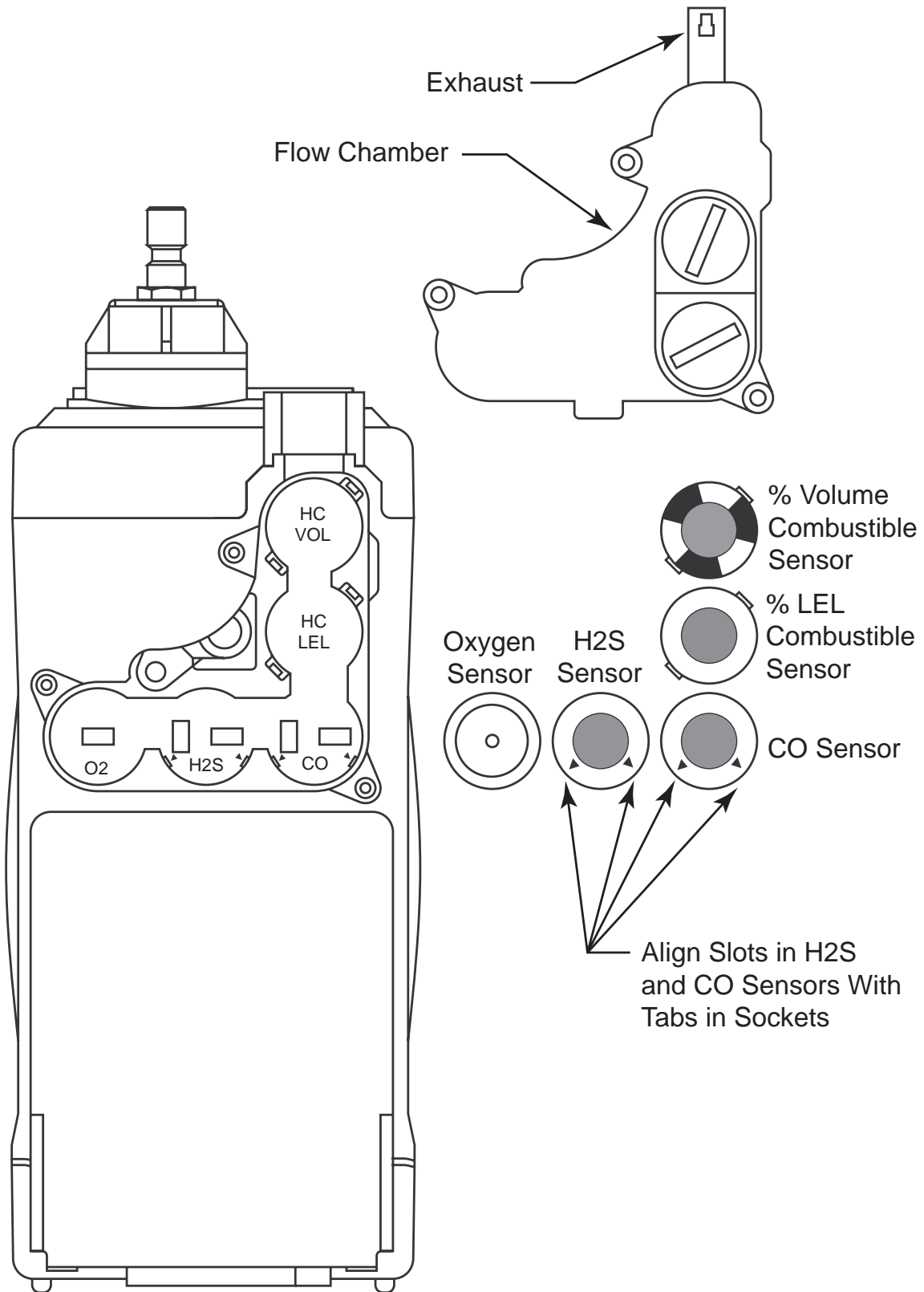

Figure 10: Replacing a Sensor

CAUTION: *When replacing a sensor, verify that the sensor is properly aligned with its socket before inserting it into the socket. The CO and H₂S sensors have alignment slots which match up with alignment tabs in the sockets. The combustible sensors each have two non-polarized contacts which must line up with the contacts in their socket. Forcing a sensor into its socket may damage the sensor or the socket.*

6. Place the flow chamber in position over the sensor area and press it into the case until it is flush with the back of the case.
7. Secure the flow chamber to the GX-2003 with the three screws removed in step 2.
8. Start up the GX-2003 by pressing and briefly holding the POWER ENTER button.
9. Calibrate the new sensor as described in “Calibration Mode” on page 38.

Replacing the Hydrophobic Disk Filter, Cotton Filter, and Wire Mesh Disk

1. Verify that the GX-2003 is off.
2. Locate the clear plastic filter holder at top of the GX-2003.
3. Grasp the filter holder and turn it about 1/8 of a turn counterclockwise.
4. Pull the filter holder away from the case. Inspect the cotton dust filter and replace if dirty.
5. The hydrophobic disk filters and wire mesh disk are located in the case and are retained by a rubber gasket. Pull out the rubber gasket with needle nose pliers.

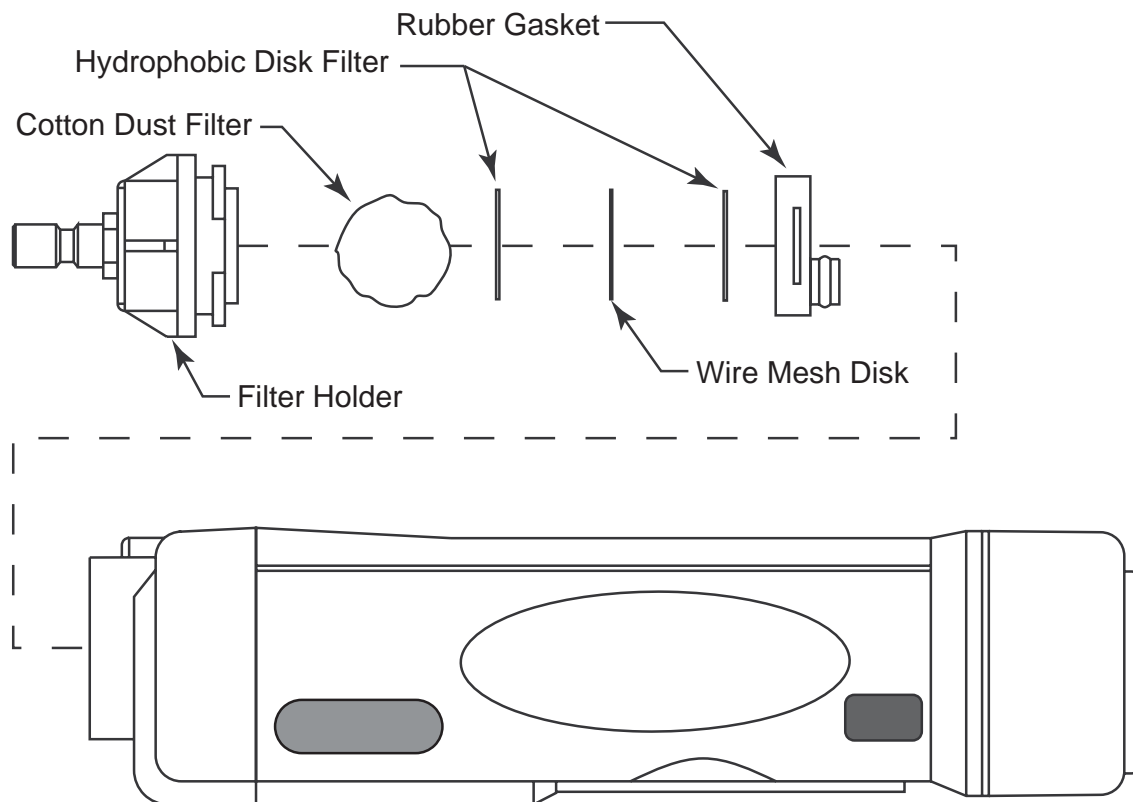

Figure 11: Changing the Filters & Wire Mesh Disk

6. Remove the old hydrophobic filters and/or wire mesh disk from the gasket. A hydrophobic filter is located on either side of the wire mesh disk.
7. Install the new hydrophobic filters and/or wire mesh disk making sure a hydrophobic filter is located on each side of the wire mesh disk.
8. Reinstall the gasket with the parts into the case.
9. Reinstall the filter holder with the cotton dust filter. Align the two wide tabs on the bottom of the filter holder with the two wide slots in the case where the filter holder fits. Push the filter holder into the case and turn it about 1/8 turn clockwise until it snaps into place.

Parts List

Table 7 lists part numbers for the GX-2003's replacement parts and accessories.

Table 7: Parts List

Part Number	Description
06-1248RK	Calibration kit tubing (specify length in feet)
07-2005RK	Gasket, filter/screen retaining
17-1001RK	Tapered rubber nozzle
20-0318RK	Rubber protective Boot w/belt clip
21-1062RK	Battery cover
21-1833RK	Filter holder, clear plastic
33-0159RK	Hydrophobic disk filter
33-1031RK	Cotton ball 25 pack, for replacement of cotton dust filter
33-1112RK	Wire mesh disk filter
33-7108RK	HC filter
33-7109RK	CO filter
47-5026RK	Downloading cable, serial/IrDA adapter
47-5027RK	Downloading cable, USB/IrDA adapter
49-1606RK	Ni-MH battery pack
49-1120RK	AA size alkaline battery
49-2160RK	115 VAC charging station
49-2161RK	12 VDC charging station
71-0089RK	Operator's Manual, Model GX-2003 (this document)
71-0096RK	Operator's Manual, GX-2003 Downloading Software
80-0009RK-XX	Sample hose. Replace "XX" with length in feet. Available lengths for the GX-2003 are 2, 3, 10, 15, 20, 25, 30, and 40 feet.
80-0150RK	10" sample probe with dust filter
80-0157RK	30" fiberglass bar hole probe
81-GX03CO	Calibration kit, for LEL/Oxy/CO unit, 58 liter
81-GX03CO-LV	Calibration kit, for LEL/Oxy/CO unit, 34 liter
81-GX03HSCO	Calibration kit, for LEL/Oxy/H2S/CO unit, 58 Liter

Table 7: Parts List (cont.)

Part Number	Description
81-GX03HSCO-LV	Calibration kit, for LEL/Oxy/H2S/CO unit, 34 Liter
81-GX03VOLHS	Calibration kit, for %VOL(CH4)/LEL/Oxy/H2S/CO unit, 58 Liter
81-GX03VOLHS-LV	Calibration kit, for %VOL(CH4)/LEL/Oxy/H2S/CO unit, 34 Liter
81-0154RK-02	Calibration cylinder for demand-flow regulator kit, 58L; four-gas (CH ₄ ; O ₂ ; CO; H ₂ S)
81-1054RK	Regulator, demand-flow type (for 58- and 103-liter calibration cylinders)
83-0007RK	Downloading software
ES-1821	Carbon monoxide sensor
ES-1821L	Carbon monoxide sensor, for low humidity use
ES-1827	Hydrogen sulfide sensor
ES-1827L	Hydrogen sulfide sensor, for low humidity use
NC-6264ALB	LEL/ppm combustibles sensor, for use with all operating modes, Normal Mode, Bar Hole Mode, and Leak Check Mode
NC-6264AT	% LEL combustibles sensor, for Normal Mode operation only
OS-BM2	Oxygen sensor
TE-7561	TC %volume combustibles sensor

Appendix A: Calibrating with a Sample Bag

Overview

The GX-2003 can be calibrated with a gas bag calibration kit instead of a demand flow regulator kit. Appendix A describes how to use a sample bag calibration kit to calibrate the GX-2003. A parts list at the end of this appendix lists spare parts for the calibration kit.

Calibration Supplies and Equipment

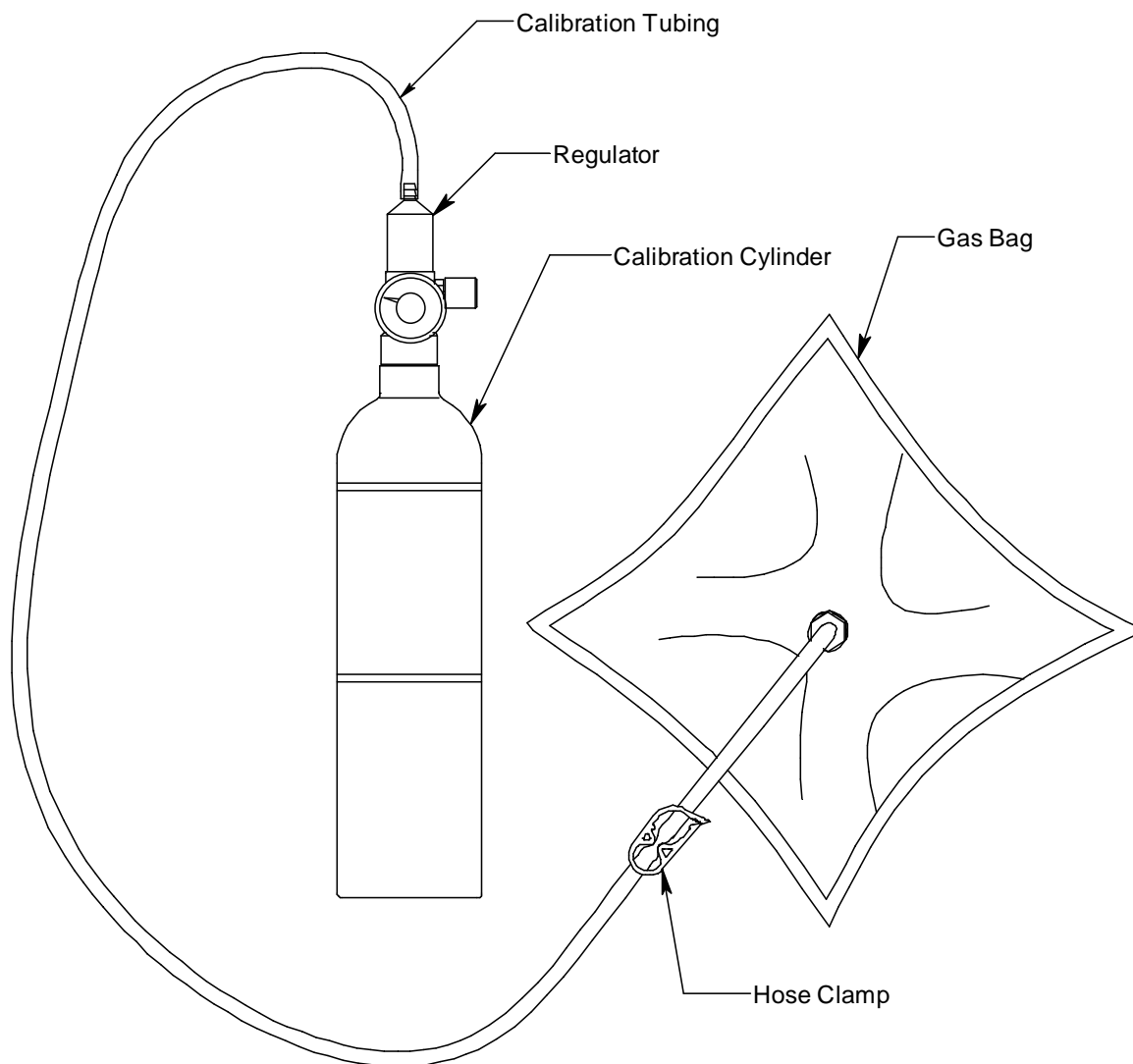

Figure 12: Gas Bag Calibration Kit

To calibrate the GX-2003, you will need:

- Known calibrating samples of the gases being detected. The combustible and toxic gas samples should have concentrations in approximately the middle of the range of detection. An oxygen-free source, such as 100% nitrogen is recommended for setting the oxygen zero when using single calibration.

WARNING: When using auto calibration, the multi-gas cylinder must have an oxygen concentration in the range of 10% - 18% oxygen.

- A gas collection bag with hose clamp
- A 0.5 LPM fixed-flow regulator or dispensing valve
- Calibration tubing

To calibrate the %LEL, Oxygen, CO, and H₂S sensors at the same time, automatically, with no need for a zero-oxygen source, you can use the auto calibration feature with a 4-gas cylinder. If the H₂S channel is not active, then a 3-gas cylinder may be used for auto-calibration. This document includes instructions for auto calibration with a fixed flow regulator or dispensing valve and a 4-gas cylinder. This document also includes instructions for calibrating one channel at a time using single calibration.

Preparing for Calibration

Whether you will calibrate the Model GX-2003 using auto calibration or single calibration, you will need to set the fresh air readings first before setting the span readings for each gas.

1. Find a fresh-air environment. This is an environment free of toxic or combustible gases and of normal oxygen content (20.9%).
2. Turn on the unit as described in “Turning on the GX-2003” in the GX-2003 Operator’s Manual using the sample hose and probe.
3. With the unit on, perform a demand zero by pressing and holding the ▲AIR button. The display prompts you to hold the ▲AIR button.
4. Continue to hold the ▲AIR button until the display prompts you to release the ▲AIR button. The GX-2003 will set the fresh air reading for all channels.

5. Slide the tubing clamp onto the tubing and connect the tubing onto the sample bag's inlet. Leave the clamp unclamped for now.
6. Connect the other end of the tubing to the regulator's or dispensing valve's hose barb fitting.
7. Fill the gas collection bag by screwing the fixed flow regulator onto the calibration cylinder or by screwing the dispensing valve onto the calibration cylinder and turning the knob counterclockwise.

NOTE: If the regulator has no On/Off knob, then gas will begin to flow at 0.5 LPM as soon as the regulator is connected to the cylinder.

8. Allow the gas to dispense until the gas collection bag is a little over half full.
9. If a fixed flow regulator without a knob is used, disconnect it from the cylinder and immediately clamp down the hose clamp to prevent the release of gas from the gas collection bag. If a fixed flow regulator with a knob or a dispensing valve is used, turn the knob clockwise to stop the gas flow, clamp down the hose clamp and remove the regulator or dispensing valve from the cylinder.
10. Disconnect the tubing from the regulator or dispensing valve.

Calibrating the GX-2003

From Measuring Mode, enter Calibration Mode by pressing and holding the (SHIFT)▼ button, then pressing the DISPLAY(ADJ) button and releasing both. If the unit prompts you for the password, enter it by using the ▲AIR and (SHIFT)▼ buttons to select each password number and then pressing and releasing POWER ENTER to enter it and move on to the next one. The calibration menu displays with the cursor next to **AUTO CALIBRATION**.

NOTE: The following screens illustrate a four-gas GX-2003 with both a % LEL and a % volume combustible sensor as examples only. Your GX-2003 may display slightly different screens.

<p>>AUTO CALIBRATION SINGLE CALIBRATION CONTRAST NORMAL OPERATION</p> <p style="text-align: right;">21:09 ██████</p>
--

The GX-2003's calibration menu includes two methods of calibration: auto calibration and single calibration.

- **Auto Calibration:** This method allows you to calibrate the CH₄(%LEL sensor only), OXY, H₂S, and CO sensors simultaneously. It is designed for use with the RKI 4-gas calibration cylinder and is the quickest and easiest method to calibrate the GX-2003.
- **Single Calibration:** This method allows you to calibrate one sensor at a time. Use this method if you are only calibrating one or two sensors, if you are calibrating the %volume combustible sensor, or if you are not using the RKI 4-gas calibration cylinder.

Calibrating with the Auto Calibration Method

This section describes calibration using the auto calibration method. To calibrate using the single calibration method, see “Calibrating with the Single Calibration Method” below.

1. With the cursor next to the **AUTO CALIBRATION** menu item, press and release the POWER ENTER button to display the calibration values screen.

C CH ₄	50%LEL
A OXY	12.0VOL%
L H ₂ S	25.0ppm
. CO	50ppm
	21:09 

The gas concentrations displayed in the calibration values screen must match the gas concentrations listed on the 4-gas calibration cylinder. If *all* concentrations match, go to step 6. If *one or more* concentrations do not match, continue with step 2.

2. To adjust the values on the screen, hold down the (SHIFT)▼ button, then press the DISPLAY(ADJ) button and release both. The CH₄ calibration value begins to flash.
3. If necessary, use the ▲AIR and (SHIFT)▼ buttons to set the correct combustible gas value.
4. Press and release the POWER ENTER button to enter the new setting. The OXY calibration value begins to flash.
5. Repeat steps 3 and 4 to set the correct values for the remaining channels. After the last channel is set, you return to the calibration values screen and the values are no longer flashing.

NOTE: The RKI Four Gas Cylinder typically contains 12% O₂ by volume. Be sure to set the “OXY” reading to agree with the concentration listed on the cylinder’s label.

6. With the calibration values screen displayed, press the POWER/ENTER button. **CAL.** along the left side of the LCD begins to flash and the current gas readings are displayed.

C CH4	0%LEL
A OXY	20.9VOL%
L H2S	0.0ppm
. CO	0ppm
	21:09 [REDACTED]

7. Connect the tubing from the gas bag to the rigid tube on the probe. Allow the GX-2003 to sample gas for approximately one minute.

WARNING: *Do not connect the regulator or dispensing valve to the GX-2003. Applying gas to the GX-2003 directly with the regulator or dispensing valve can result in damage to the GX-2003’s pump.*

8. Press and release the POWER/ENTER button to set the calibration to the programmed values.

If all channels passed calibration, **AUTO CALIBRATION END** displays, then the calibration menu displays.

If any of the sensors cannot calibrate to the proper value, **FAIL PUSH AIR KEY** displays and the GX-2003 lists the sensor(s) that failed to calibrate. In the example below, the OXY and H2S channels failed calibration. The other sensors calibrated normally.

FAIL			
PUSH AIR KEY			
<	>	<	>
<O2 >	<	>	<CO >
		21:09	[REDACTED]

The buzzer, vibrator, and alarm lights activate. Press and hold the ▲AIR button for a few seconds to reset the alarm and return to the calibration menu. Attempt to calibrate again. If the failure continues, investigate the cause. See the “Troubleshooting” section in the Operator’s Manual.

9. Disconnect the tubing from the GX-2003’s probe.
10. Use the (SHIFT)▼ button to place the cursor next to the **NORMAL OPERATION** menu option, then press and release the POWER ENTER button to return to Measuring Mode.

Calibrating with the Single Calibration method

This section describes calibration using the Single Calibration method. To calibrate using the Auto Calibration method, see “Calibrating with the Auto Calibration Method” above.

CAUTION: *The single calibration method does not have a “FAIL” notification. If a sensor cannot be set to agree with the calibration source, see the “Troubleshooting” section of the Operator’s Manual.*

1. While in the calibration menu, use the ▲AIR or (SHIFT) ▼ button to place the prompt next to the **SINGLE CALIBRATION** menu option.

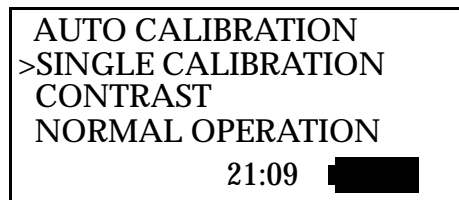

AUTO CALIBRATION
>SINGLE CALIBRATION
CONTRAST
NORMAL OPERATION
21:09 [REDACTED]

2. Press and release the POWER/ENTER button to display the single calibration menu.

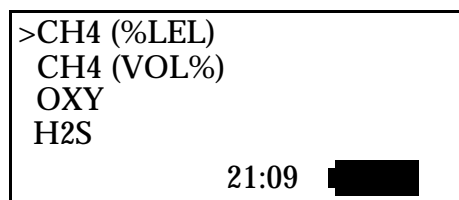

>CH4 (%LEL)
CH4 (VOL%)
OXY
H2S
21:09 [REDACTED]

NOTE: To display the CO sensor, use the (SHIFT) ▼ button to move the cursor to the bottom of the screen and then press it again to advance to the next screen.

3. Use the ▲AIR or (SHIFT) ▼ button to place the cursor next to the sensor you want to calibrate (in this example the combustible gas %LEL sensor).
4. Press and release the POWER/ENTER button. The single calibration screen displays for the sensor you selected. The gas reading flashes.

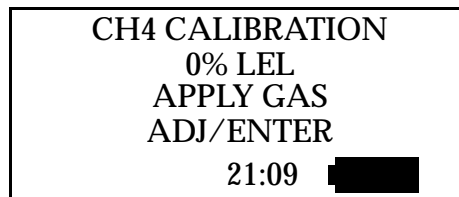

CH4 CALIBRATION
0% LEL
APPLY GAS
ADJ/ENTER
21:09 [REDACTED]

5. Connect the tubing from the gas bag to the rigid tube on the probe. Allow the GX-2003 to sample gas for one minute.

6. If necessary, use the ▲AIR and (SHIFT)▼ buttons to adjust the reading to match the concentration listed on the calibration cylinder.
7. Press and release the POWER ENTER button to save the span value. The LCD will indicate that the calibration has ended, then the single calibration menu displays.
8. Disconnect the tubing from the GX-2003's probe.
9. Repeat steps 3 through 8 for any other channels you want to calibrate. Make sure you use an appropriate calibration cylinder for each channel.

CAUTION: *When calibrating the oxygen channel, verify the concentration of oxygen listed on the cylinder's label. For oxygen-free samples (100% nitrogen for example), set the oxygen zero setting to 0.0%.*

10. After the last channel is calibrated, disconnect the calibration tubing from the probe.
11. With the Single Calibration menu displayed, press the (SHIFT)▼ button until the cursor is next to the **ESCAPE** menu item.
12. Press and release the POWER ENTER button to return to the calibration menu.
13. Use the (SHIFT)▼ button to place the cursor next to the **NORMAL OPERATION** menu item, then press and release the POWER ENTER button to return to Measuring Mode.

Parts List

Table 8: Sample Bag Calibration Kit Spare Parts

Part Number	Description
81-0013RK-01	Calibration cylinder, 50% volume methane in nitrogen, 34 liter
81-0018RK-01	Calibration cylinder, 50% isobutane in air, 34 liter
81-0090RK-01	Calibration cylinder, 3-gas mix, LEL/Oxygen/CO, 34 liter
81-0154RK-04	Calibration cylinder, 4-gas mix, LEL/Oxygen/CO/H ₂ S, 34 liter
81-1001RK	Dispensing valve, for 17/34 liter cylinders
81-1051RK	Regulator with gauge and knob, 34AL/58 liter/103 liter cylinders, 0.5 LPM
81-1126RK	Gas bag with clamp and hose barb, 9" x 9", 2 liter