



QRAE II Quick Reference
Covers Diffusion & Pump Models
with Firmware Version 3.12 and higher

WARNINGS

Use only RAE Systems rechargeable battery pack part number 020-3402-000, or alkaline battery pack part number 020-3403-000. Use only DURACELL MN1500 batteries with alkaline battery pack. This instrument has not been tested in an explosive gas/air atmosphere having an oxygen concentration greater than 21%. Substitution of components may impair suitability for intrinsic safety. Recharge batteries only in non-hazardous locations. Do not connect the serial communication port in a hazardous location.

STATIC HAZARD: Clean only with a damp cloth.

For safety reasons this equipment must be operated and serviced by qualified personnel only. Read and understand instruction manual completely before operating or servicing. Only the combustible gas detection portion of this instrument has been assessed for performance.

All newly purchased RAE Systems instruments should be bump tested by exposing the sensor(s) to known concentration calibration gas before the instrument is put into service, and later, prior to each use. A bump test is defined as a brief exposure of the monitor to the calibration gas and the sensors to show response and trigger the lowest alarm set point for each sensor.

- The QRAEII Multi Gas detector must be calibrated if it does not pass a Bump Test, or at least once every 180 days, depending on use and sensor exposure to poisons and contaminants.
- Calibration intervals and bump test procedures may vary due to national legislation.
- When using an H₂S sensor in a QRAE II, RAE Systems recommends using RAE calibration gas cylinders with a 4 gas mix containing 10 ppm H₂S, 50 ppm CO, 50% LEL Methane, and 18% Oxygen.

Any rapid up-scale reading followed by a declining or erratic reading may indicate a gas concentration beyond upper scale limit which may be hazardous.

Important

This Quick Reference provides operational information for the QRAE II. It is not intended as a substitute for the User's Guide. The User's Guide must be carefully read by all individuals who have or will have the responsibility of using, maintaining, or servicing this product. The product will perform as designed only if it is used, maintained, and serviced in accordance with the manufacturer's instructions.

Standard Contents

QRAE II

Calibration Adapter (diffusion model only)

Water Trap Filter (pump model only)

Quick Start Guide

Alkaline Battery Adapter

CD-ROM with User's Guide and related materials, ProRAE Studio Software

Package for Windows 2000, NT and XP

(Rechargeable version only) Charging/download cradle with computer interface cable

(Rechargeable version only) AC/DC Adapter with international plugs

(Rechargeable version only) Lithium-Ion battery pack



Setting Up The Charging Cradle

Before charging the rechargeable Li-ion battery, you must set up the charging cradle. Its AC/DC adapter is designed for use anywhere in the world and is able to handle voltages between 100 VAC and 240 VAC at either 50 Hz or 60 Hz. It comes with several plugs that snap into place on the base of the AC/DC adapter.

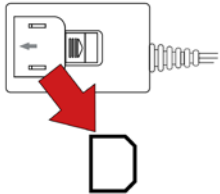
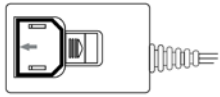

1. Remove the plastic spacer piece from adapter's receptacle.

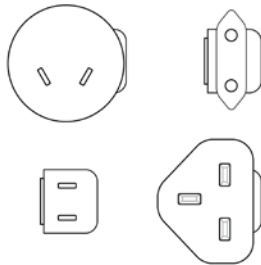

2. Select the correct plug for your region.

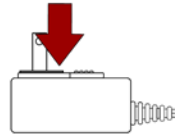
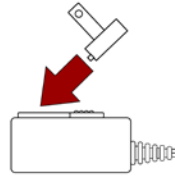

3. Tilt the plug into the adapter's receptacle, aligning the small ledge with the cutout inside the receptacle.

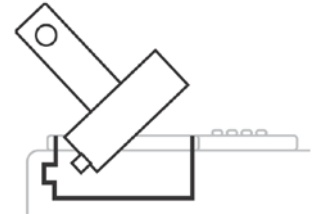

4. Connect the adapter's plug to the receptacle on the back of the cradle.

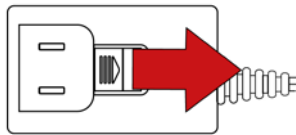

5. If you need to remove the plug, slide the capture plate to release the plug, and tilt out the plug from the receptacle.

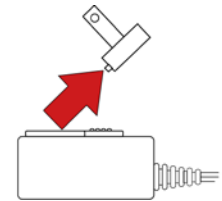
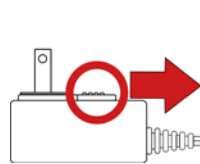

Charging The Battery

Always charge the QRAE II before use. To charge the QRAE II:

1. Plug the AC/DC adapter into the QRAE II's cradle.
2. Plug the AC/DC adapter into the wall outlet.
3. Place the QRAE II into the cradle and press down until the charging LED glows.

Red charging LED: Unit charging
Green charging LED: Unit charged

Note: A full recharge of the Li-ion battery typically requires six hours.

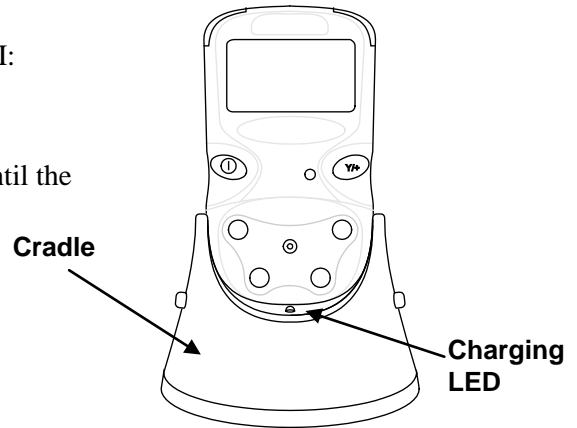

Turning The QRAE II On

Hold down [MODE] for 2 seconds. When starting up, the QRAE II simultaneously turns the backlight on and off, beeps once, blinks once, and vibrates. It performs diagnostics and tells you current settings.

Turning The QRAE II Off

Press and hold [MODE]. In 2 seconds, a 5-second countdown to shutoff begins. You must hold your finger on the key for the entire shutoff process. If you remove your finger from the key during the countdown, the shutoff operation is canceled and the QRAE II continues normal operation.

User Interface

The QRAE II's user interface consists of the display, LEDs, an alarm transducer, and two keys, labeled [MODE] and [Y/+]. The LCD display provides visual feedback that includes time, sensor mode, battery condition, and datalog enable/disable status.

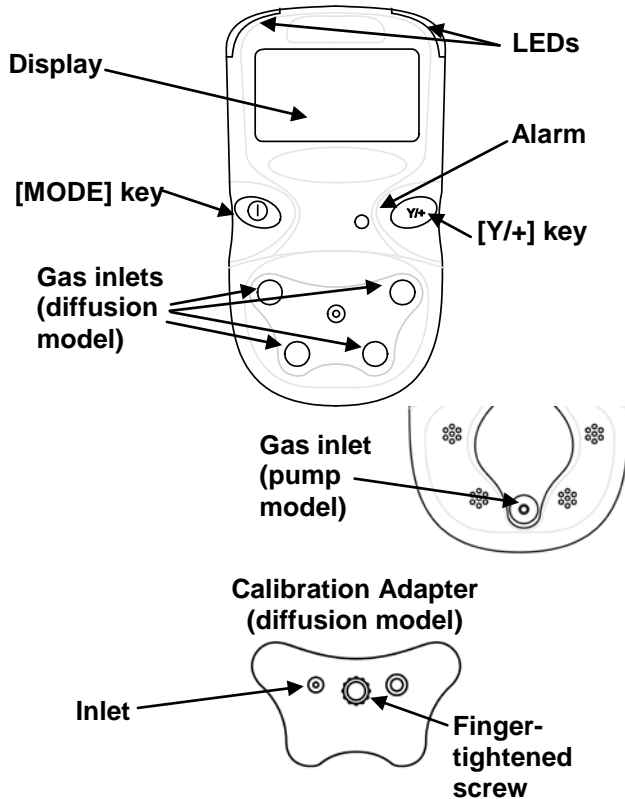

User Interface Icons	
Icon	Indication
	Battery Voltage low (flashing) Battery Low alarm triggered
	Battery fully charged
	Battery charging
	Alkaline Battery Adapter in use
	Alkaline Battery cannot be charged
	Datalogging active (flashing)
	Datalog memory full
	Pump running
	Pump blocked (blinks on and off)

Everyday Use

With the QRAE II turned off, press and hold [MODE]. When the display turns on, release the key. The QRAE II is now in the normal operating mode (Normal Mode).

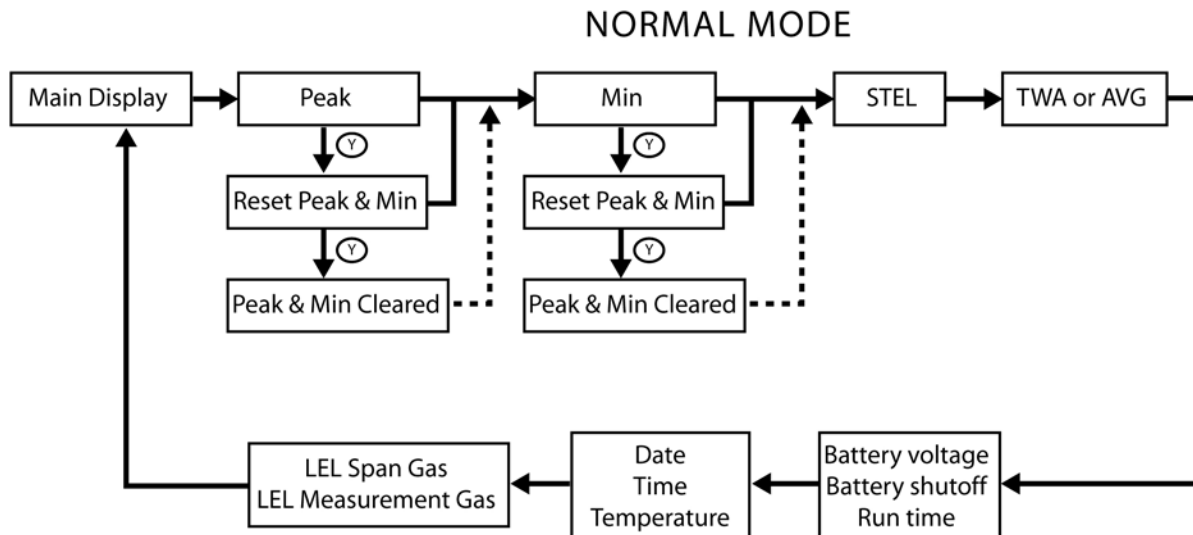

Use MODE key (M) to advance, except where noted.

Note: For more information on Normal Mode, refer to the QRAE II User's Guide.

Bump Testing And Calibration

RAE Systems recommends that a bump test be performed on the QRAE II before the monitor is put into service, and later, prior to each use. A bump test is defined as a brief exposure of the monitor to the calibration gas and the sensors to show response and trigger the lowest alarm set point for each sensor.

- The QRAE II Multi Gas detector must be calibrated if it does not pass a Bump Test, or at least once every 180 days, depending on use and sensor exposure to poisons and contaminants.
- Calibration intervals and bump test procedures may vary due to national legislation.
- When using an H₂S sensor in a QRAE II, RAE Systems recommends using RAE calibration gas cylinders with a 4 gas mix containing 10 ppm H₂S, 50 ppm CO, 50% LEL Methane, and 18% Oxygen.

Important! Make sure you have the correct calibration gas in the correct concentration. Also make sure that the calibration gas is not beyond its “Best when used by” date, which is stamped on the cylinder’s label. The following diagram shows Programming Mode’s five submenus and how to navigate through them.

Note: Press [MODE] to navigate from one menu choice to the next and [Y/+] to make selections.

1. If the QRAE II is off, turn it on (hold down [MODE] for 2 seconds).
2. After startup, press and hold both keys.
3. Press the [MODE] key to advance to OK.
4. Press [Y/+]. The QRAE II is now in Programming Mode’s Calibrate Monitor submenu.

Note: Refer to the QRAE II User’s Guide for information on password-protected QRAE IIs.

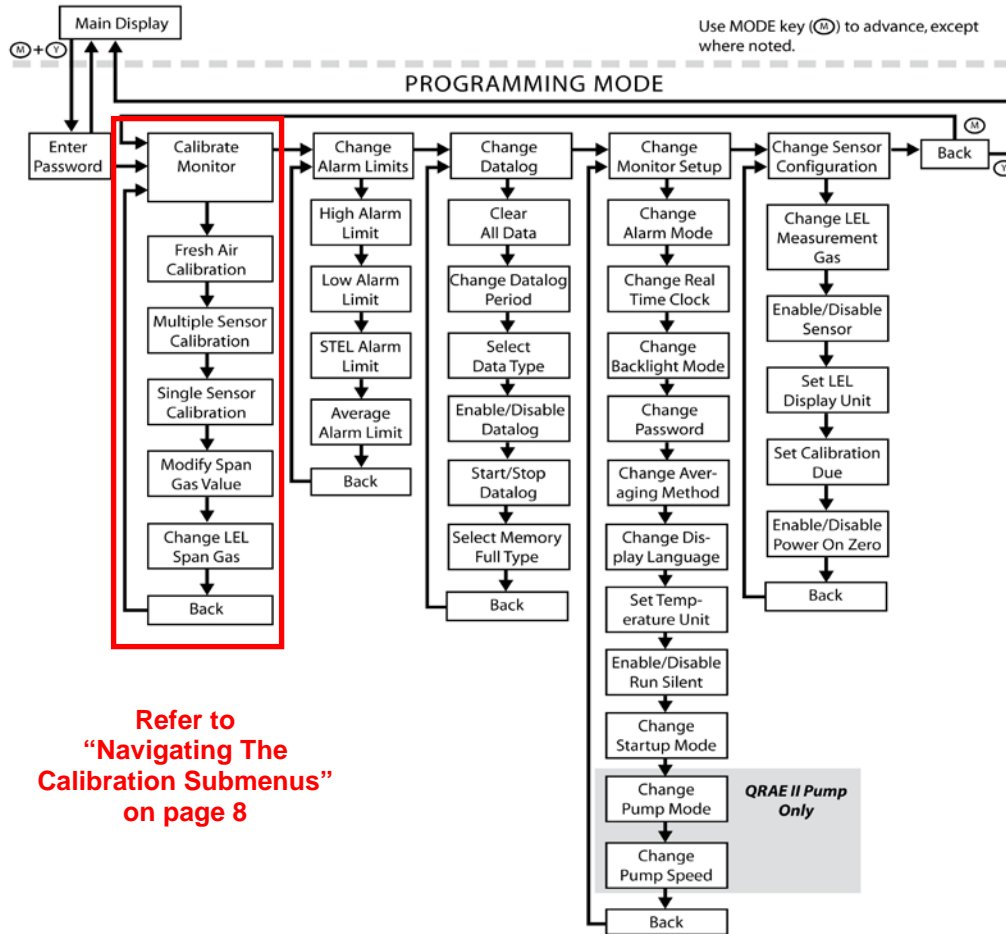

Refer to
**“Navigating The
 Calibration Submenus”**
 on page 8

Navigating The Calibration Submenus



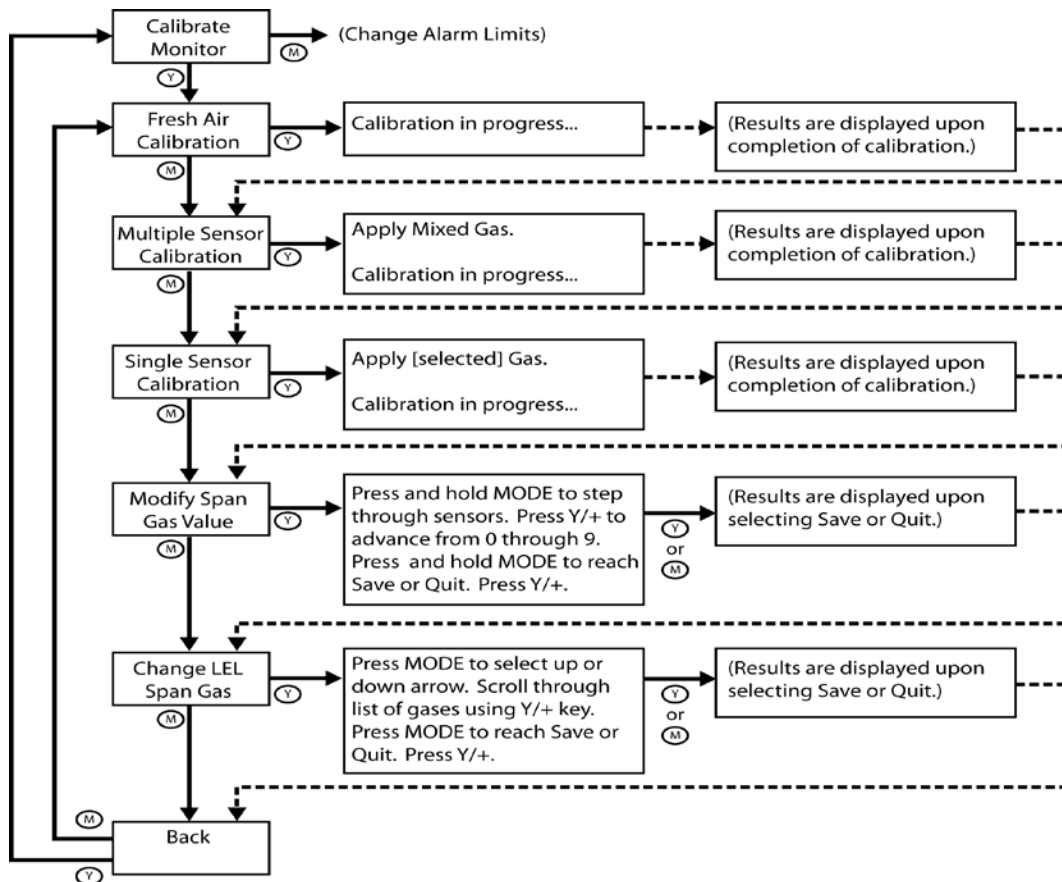

The submenus and actions are shown in the following diagram:



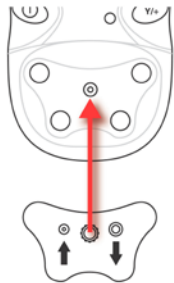

Calibrating The QRAE II

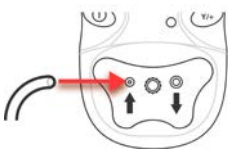
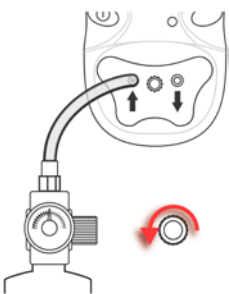
Calibration is covered in detail in the section “Calibrating The QRAE II,” in the QRAE II User’s Guide.

Diffusion Model

				
1. Place calibration adapter over filter area.	2. Finger-tighten screw to fasten calibration adapter.	3. Attach hose from calibration gas source.	4. Open calibration gas regulator and start calibration.	5. Remove the calibration adapter.

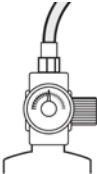
Pump Model

			
1. Connect hose to inlet.	2. Attach hose to calibration gas.	3. Open gas regulator and start calibration.	4. Remove hose.

Zero (Fresh Air) Calibration

This procedure determines the zero point of the sensor calibration curve. Expose the inlet to a clean air source with 20.9% oxygen and without any organic, toxic or combustible gas impurities. This “Zero Air” can be from a cylinder, clean ambient air, or ambient air purified through a charcoal filter.

Caution! If your QRAE II is a diffusion model, do not use the Calibration Adapter while performing zero calibration in fresh air.

1. If the QRAE II is off, turn it on (hold down [MODE] for 2 seconds).
2. After startup, press and hold both keys.
3. At Calibrate Monitor, press [Y/+]. The display should show: **Fresh Air Calibration?**
4. Press Y+ to start calibration. Calibration is performed automatically (there is a 30-second countdown).

When the zero calibration is successful, the display should show a reading of “20.9” for the oxygen sensor and “0” for all other sensors.

Multiple Sensor Calibration

Select a sensor to calibrate by pressing [MODE] until the sensor's name is highlighted. Then press [Y/+] to toggle the selection on (indicated by an asterisk, *) or off (no asterisk). To select other sensors to calibrate, press [MODE] until you reach the sensor you want to select. Then press [Y/+] .

After you have selected all the sensors you want calibrated, it is time to perform the calibration.

1. Attach the Calibration Adapter to the QRAE II (diffusion model only).
2. Attach the regulator to the Calibration Gas cylinder.
3. Attach a hose to the Calibration Adapter and to the regulator (diffusion model only), or attach hose to the inlet (pump model).
4. Turn on the regulator to start the Calibration Gas flow.
5. Press [MODE] until OK is highlighted.
6. Press [Y/+] to start calibration. You should see a countdown from 60 seconds.

Note: If you see the following message, check that the gas is flowing and the hose is attached:

No Gas Flow... Apply gas or hit any key to start.

When calibration is complete, the screen displays this message: **Multiple Sensor Calibrated!**

If a sensor fails, try calibrating again. If calibration fails again, replace the sensor.

Note: If you want to perform a single-sensor calibration, refer to the QRAE II User's Guide.



RAE Systems by Honeywell World Headquarters

3775 N. First St.
San Jose, CA 95134-1708 USA
Phone: +1 408.952.8200
Fax: +1 408.952.8480

RAE Systems Europe

Kristinehøj 23 A, DK-2770 Kastrup, Denmark
Phone: +45 86 52 51 55
Fax: +45 86 52 51 77
orders@raeeurope.com
sales@raeeurope.com
service@raesystems.com
Web: www.raesystems.eu

RAE Systems Asia

RAE Systems (Hong Kong) Ltd.
Units 1516-18, 15/F, Delta House, 3 On Yiu Street
Shatin, N.T. Hong Kong
Phone: +852.2669.0828
Fax: +852.2669.0803
Email: asiasales@raesystems.com

Technical Support

Monday through Friday,
7:00 AM to 5:00 PM Pacific (US) Time

Phone (toll-free): +1 888-723-4800
Phone: +1 408-952-8461
Email: tech@raesystems.com

RAE Systems Middle East

LOB 7, Ground Floor, Office 19
Jebel Ali Free Zone
Dubai, United Arab Emirates
Phone: +971.4.887.5562
Fax: +971.4.887.5563
Email: mesales@raesystems.com