

OAKION®

pH/CON 510

Benchtop Meter

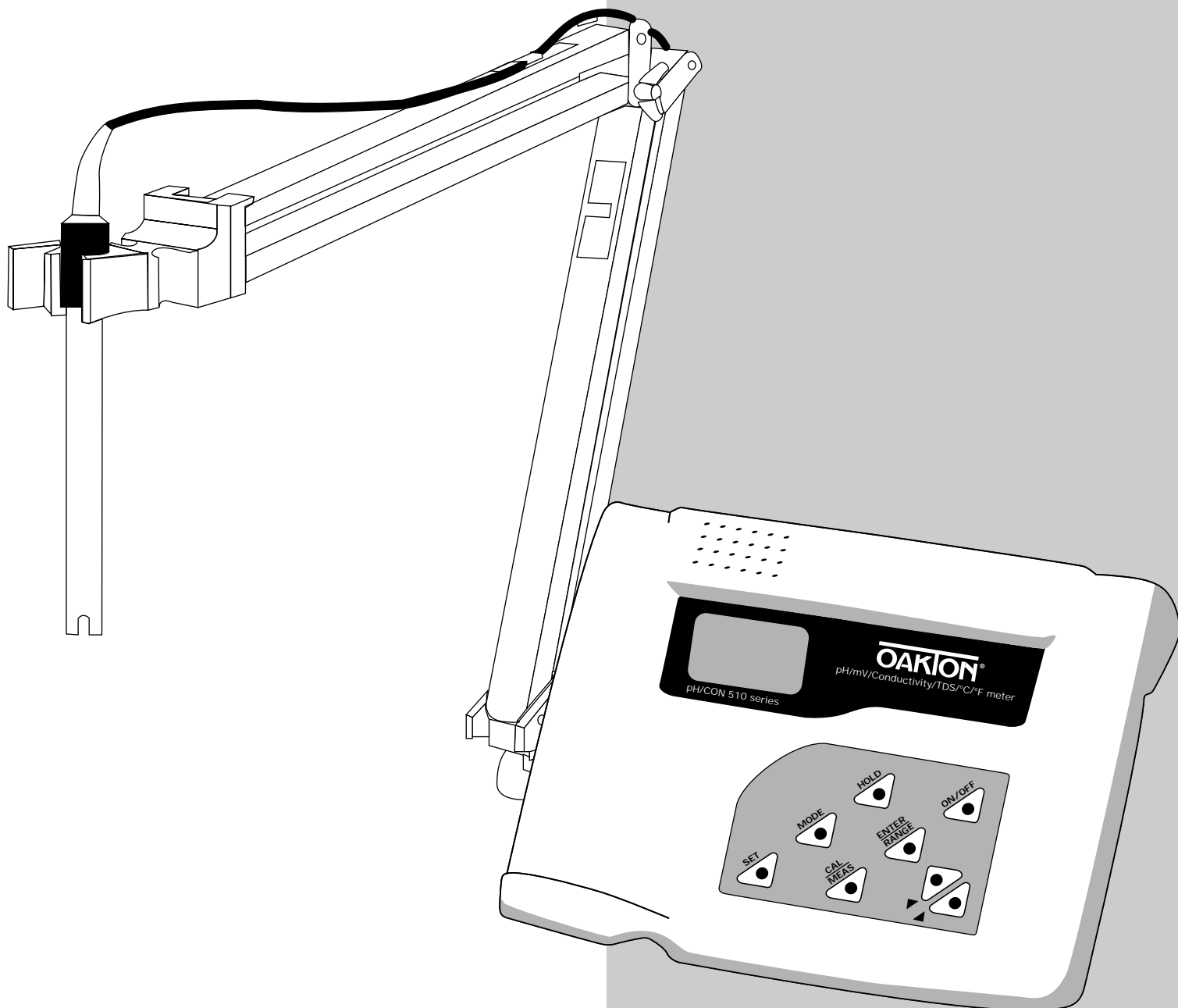

pH/CON 510 meter

WD-35610-10, -12, -15, -17

OAKION®

10/00 ©2000

68X090817

Table of contents

Starting up	4-8	Probe Care	38-39
Keypad	4	Electrode activation	38
Display	5	Electrode maintenance	38
Electrode holder arm	6-7	Storing pH/ORP electrodes	38
Probe connections	8	Electrode cleaning	39
Power connections	8	Conductivity/TDS probe care	39
Calibration	9-14	Troubleshooting	40-41
Important information on meter calibration	9	Error messages	40
pH calibration	10-11	Troubleshooting	41
Conductivity/TDS calibration	12-13	Specifications	42
Temperature calibration	14	Accessories	43
Measurement	15-21	Appendix 1: Conductivity to TDS conversion factors	44
pH measurements	15	Appendix 2: Calculating temperature coefficients	45
mV measurements	16	Appendix 3: pH and temperature	46
Conductivity /TDS measurements	17	Appendix 4: Meter factory default settings	47
HOLD function/Ready indicator/Auto endpoint	18	Warranty	48
Using manual ranging function: conductivity/TDS	19	Return of Items	48
Selecting manual temperature compensation:			
conductivity /TDS	20		
Selecting a manual temperature compensation value ..	21		
Advanced Setup mode	23-37		
Advanced setup mode overview	23-25		
P1.0: Viewing previous pH calibration data	26		
P2.0: Viewing pH electrode data	27		
P3.0: pH configuration	28-29		
P3.1: Ready indicator and auto endpoint functions	28		
P3.2: Selecting number of pH calibration points	28		
P3.3: Selecting NIST or USA buffer sets	29		
P3.4: Selecting °C or °F	29		
P4.0: Resetting to factory default settings (pH)	30		
P5.0: Viewing previous con./TDS calibration data	31		
P6.0: Viewing con./TDS probe data	32		
P7.0: Conductivity/TDS configuration	33-35		
P7.1: Ready indicator and auto endpoint functions	33		
P7.2: Selecting °C or °F	34		
P7.3: Selecting Automatic/Manual temp. comp.	34		
P7.4: Setting the TDS factor	35		
P8.0: Temperature settings	36		
P8.1: Selecting the temperature coefficient	36		
P8.2: Selecting the normalization temperature	36		
P9.0: Resetting to factory default settings (con./TDS) ..	37		

starting up
calibration
measurement
setup mode
electrode care
troubleshooting
specifications
accessories
appendixes
warranty
return of items

Quick tip
 let the mini table of contents in the outer margins of this manual guide you instantly to the right section

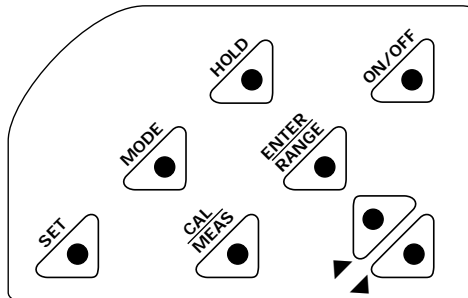
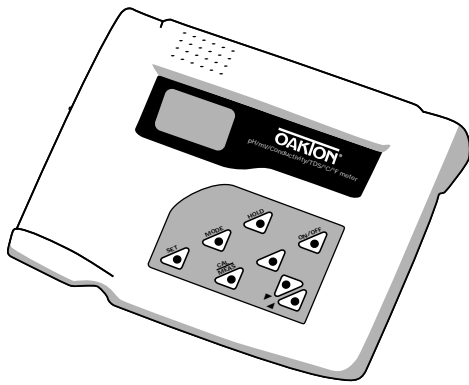

Figure 1

- starting up
- calibration
- measurement
- setup mode
- electrode care
- troubleshooting
- specifications
- accessories
- appendixes
- warranty
- return of items

1. Starting up

Thank you for purchasing an OAKTON® pH/CON 510 benchtop meter. This multiparameter meter reads pH, mV, Conductivity, Total Dissolved Solids (TDS), and temperature (°C or °F). It is microprocessor controlled, user-friendly and reliable.

Keypad

See Figure 1.

A large membrane keypad makes the meter easy to use. Names and symbols describe the function button controls.

ON/OFF

Powers the meter **ON/OFF**. When the meter is switched on, it starts in the mode the meter was last in when powered down.

ENTER/RANGE

ENTER Press to confirm values in Calibration mode and to confirm selections in Setup mode.

RANGE Press to switch to manual ranging in Conductivity or TDS mode.

CAL/MEAS

Toggles user between Calibration and Measurement mode. Example: If you are in pH measurement mode, press CAL/MEAS to enter pH calibration mode.

NOTE: Temperature calibration is available from pH, TDS, or Conductivity calibration mode; see page 14 for directions.

In Set up mode: Press CAL/MEAS to return to main menu from sub menus. Press CAL/MEAS again to return to measurement mode from main menu.

HOLD

Freezes the measured reading. To activate, press HOLD while in measurement mode. To release, press HOLD again. NOTE: When auto endpoint feature is switched on, meter automatically holds reading after 5 seconds of stability. The HOLD indicator appears on the display. Press HOLD to release auto endpoint feature.

MODE

Measurement: Press **MODE** to toggle between pH, mV, conductivity and TDS.

Calibration: In calibration mode, press **MODE** to access temperature calibration.

SET

Enters advanced set up mode. SETUP mode lets you customize meter preferences and defaults, and view calibration and probe data.



Press in Setup mode to scroll through subgroups. Also lets you increment/decrement the values in the conductivity, TDS and temperature calibration modes.

Display

See Figure 2.

The OAKTON® pH/CON 510 meter features a large dual display that shows the measured parameter in the primary display, plus temperature in °C or °F in the secondary display. It also features mode annunciators that describe the meter's functions.

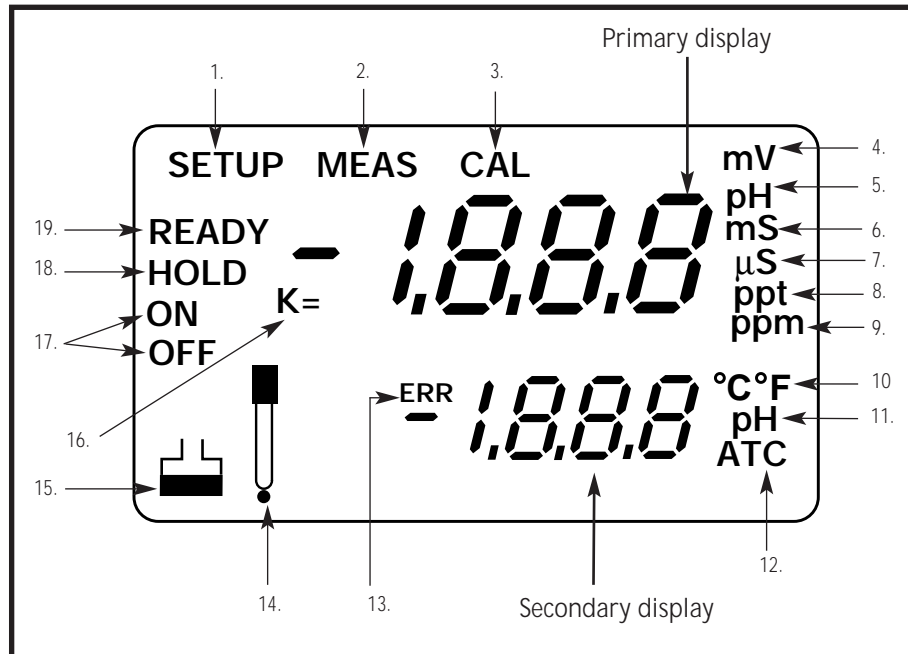

Figure 2

- | | | |
|-------------------------------|--|-----------------------------|
| 1. SETup mode indicator | 8. Parts per thousand (Total Dissolved Solids) indicator | 14. Probe indicator |
| 2. MEASurement mode indicator | 9. Parts per million (Total Dissolved Solids) indicator | 15. Calibration indicator |
| 3. CALibration indicator | 10. Temperature indicators | 16. Cell constant indicator |
| 4. mV indicator | 11. pH setup indicator | 17. ON/OFF indicator |
| 5. pH measurement indicator | 12. Automatic Temperature Compensation indicator | 18. HOLD indicator |
| 6. Millisiemens indicator | 13. ERRor indicator | 19. READY indicator |
| 7. Microsiemens indicator | | |

- starting up
- calibration
- measurement
- setup mode
- electrode care
- troubleshooting
- specifications
- accessories
- appendixes
- warranty
- return of items

- starting up
- calibration
- measurement
- setup mode
- electrode care
- troubleshooting
- specifications
- accessories
- appendixes
- warranty
- return of items

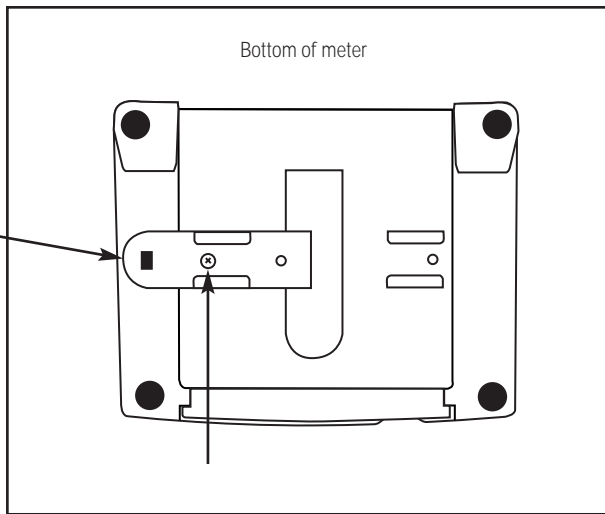

Figure 3

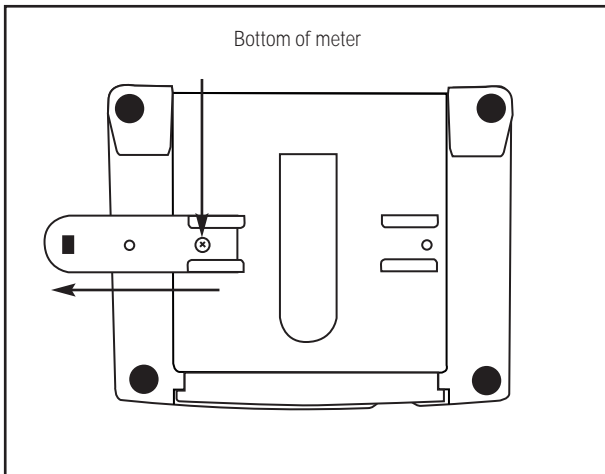

Figure 4

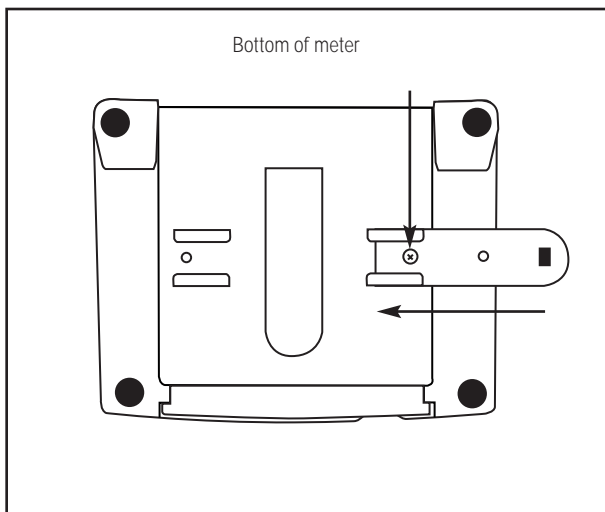

Figure 5

Electrode Holder Arm

The electrode holder is included in the same box as the meter.

To attach the electrode holder to the meter:

1. The electrode holder base attached to the bottom of the meter comes in the shipping position.

See Figure 3.

2. Use a Phillips screwdriver to remove the screw holding the electrode holder in shipping position.

See Figure 3.

3. Slide the electrode base away from the meter until the second screw slot lines up with the original screw hole. Use the screw removed earlier to secure electrode holder base into position.

See Figure 4.

4. The electrode holder arm is reversible. If desired, remove screw holding electrode holder base and slide base out of brackets. Slide base into brackets on opposite side and replace screw.

See Figure 5.

5. To install the electrode arm, turn meter back to the upright position.

See Figure 6.

6. Line up the hole on the base of the electrode holder arm with the peg on the electrode holder base. Slide the hole securely onto the electrode holder base.

See Figure 7.

The electrode arm is now ready to swing into desired position.

See Figure 8.

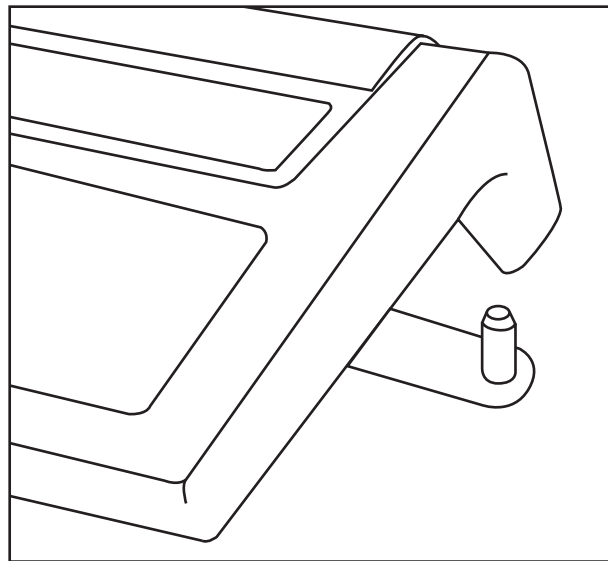

Figure 6

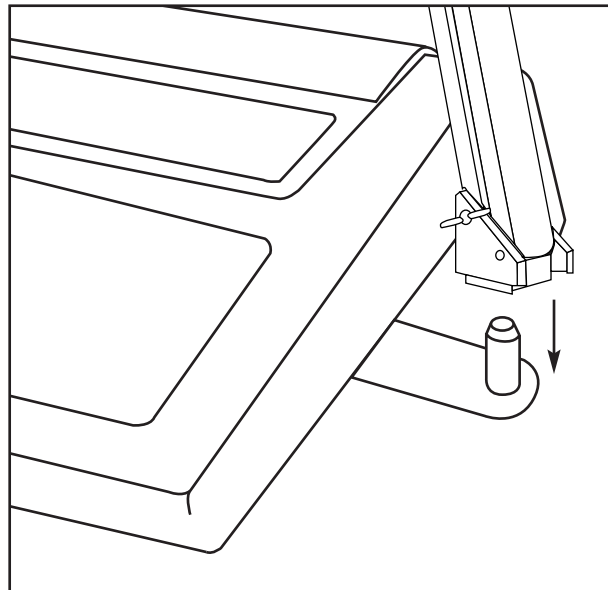

Figure 7

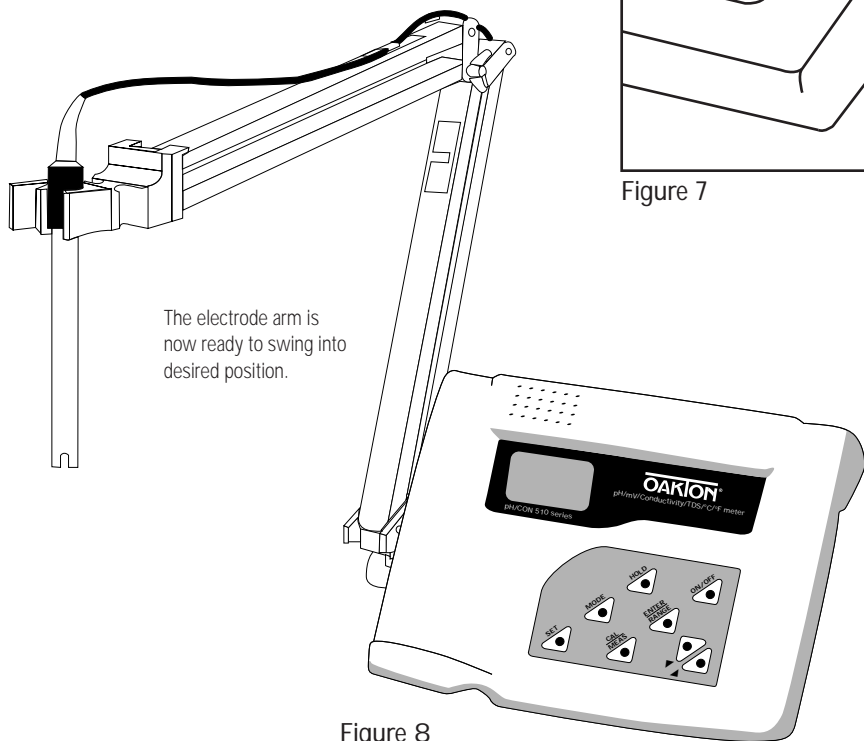

Figure 8

starting up

calibration

measurement

setup mode

electrode care

troubleshooting

specifications

accessories

appendixes

warranty

return of items

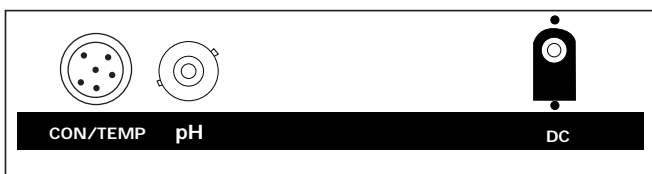

Figure 9

Attention!
 Do not get water on the connectors during operation. Avoid touching the connector with soiled or wet hands. Do not pull on the probe cord or the probe wires might disconnect.

starting up

calibration

measurement

setup mode

electrode care

troubleshooting

specifications

accessories

appendixes

warranty

return of items

Probe connections

See Figure 9 .

Your meter includes two probes:

- **pH electrode with BNC connector**
- **conductivity/TDS/temperature probe with a notched 6-pin connector**

The temperature sensing element built into the conductivity/TDS probe will also compensate for pH readings as long as both probes are in your solution at the same time.

If you want to use an “All in One” pH probe with a built-in temperature element, or if you want to use a separate temperature probe, you will need to disconnect the conductivity/TDS probe to allow for connection of the separate temperature sensor.

You can use any standard pH, mV (ORP) or Ion Selective electrode with a BNC connector with this meter. Conductivity/TDS probes, “All in One” pH electrodes with a built-in temperature element, and separate temperature probes require a probe with a notched 6-pin connector. For replacement probes, see the “Accessories” section, page 43.

To connect the pH electrode:

1. Slide the BNC connector of the probe over the BNC connector socket on the meter. Make sure the slots of the connector are in line with the posts of the socket. Rotate and push the connector clockwise until it locks.
2. To remove probe, push and rotate the connector counterclockwise. While holding onto the metal part of the connector, pull probe away from the meter.

To connect the conductivity/TDS/temperature probe:

1. Line up the notch and 6 pins on the meter with the holes in the 6-pin connector. Push down and turn the locking ring clockwise to lock into place.
2. To remove probe, turn locking ring counterclockwise on the probe connector. Pull probe away from the meter.

NOTE: follow the same directions to connect an optional separate temperature element.

Power connections

See Figure 9 .

Your meter includes an AC to DC adapter:

To connect the AC adapter:

1. Slide the phono plug of the AC adapter into the “DC” slot on the back of the meter.

2. Calibration

Important Information on Meter Calibration

When you recalibrate your meter, old calibration points are replaced on a "point by point" basis in pH, and on a "range by range" basis in conductivity or TDS.

For example:

- pH: if you previously calibrated your meter at pH 4.01, 7.00, and 10.01, and you recalibrate at pH 7.00, the meter retains the old calibration data at pH 4.01 and pH 10.01.
- Conductivity/TDS: if you previously calibrated your meter at 1413 μS in the 0 to 1999 μS range and you recalibrate at 1500 μS (also in the 0 to 1999 μS range), the meter will replace the old calibration data (1413 μS) in that range. The meter will retain all calibration data in other ranges.

Note that if you calibrate a TDS value in an equivalent conductivity range, the TDS value will replace the previous conductivity value, and vice versa.

To view current calibration points:

- pH: Program P1.0 in the SETUP section, page 26.
- Conductivity/TDS: Program P5.0 in the SETUP section, page 32.

To completely recalibrate your meter, or when you use a replacement probe, it is best to clear old calibration data by resetting the meter.

To reset the meter to its factory defaults:

- pH: Program P4.0 in the SETUP section, page 30.
- Conductivity/TDS: Program P9.0 in the SETUP section, page 37.

NOTE: Resetting the meter will set meter to factory defaults. Conductivity/TDS and pH must be reset separately.

Preparing the Meter for Calibration

Before starting calibration, make sure you are in the correct measurement mode. When you switch on the meter, the meter starts up in the units last used. For example, if you shut the meter off in "pH" units, the meter will read "pH" units when you switch the meter on.

Do not reuse calibration solutions after calibration. Contaminants in the solution can affect the calibration, and eventually the accuracy of the measurements. See page 43 for information on our high-quality calibration solutions.

More information

- See section 2.1 (pages 10-11) for pH calibration
- See section 2.2 (pages 12-13) for conductivity/TDS calibration
- See section 2.3 (page 14) for Temperature Calibration

starting up

calibration

measurement

setup
mode

electrode
care

troubleshooting

specifications

accessories

appendixes

warranty

return of
items

- starting up
- calibration
- measurement
- setup mode
- electrode care
- troubleshooting
- specifications
- accessories
- appendixes
- warranty
- return of items

pH calibration

We recommend that you perform at least a 2-point calibration using standard buffers that bracket (one above and one below) the expected sample range.

Preparing for pH calibration

This meter is capable of up to 5-point pH calibration to ensure accuracy across the entire pH range of the meter. The meter automatically recognizes and calibrates to these standard buffer values, which makes pH calibration faster and easier.

Select from the following buffer options:

USA: pH 1.68, 4.01, 7.00, 10.01, and 12.45.

NIST: pH 1.68, 4.01, 6.86, 9.18, and 12.45.

To select the buffer set, see Setup Program P3.3 on page 29.

The pH/CON 510 meter also lets you select the number of pH calibration points the meter will use in calibration mode: 2, 3, 4, or 5. The meter will automatically exit calibration mode after you have calibrated to your selected number of points. See Setup Program P3.2 on page 28.

Before starting

Be sure to remove the protective electrode storage bottle or rubber cap of the probe before calibration or measurement. If the electrode has been stored dry, wet the probe in tap water for 10 minutes before calibrating or taking readings to saturate the pH electrode surface and minimize drift.

Wash your probe in deionized water after use, and store in electrode storage solution. If storage solution is not available, use pH 4.0 or 7.0 buffer. DO NOT store electrode in distilled or deionized water.

To calibrate pH:

1. If necessary, press the MODE key to select pH measurement mode. The pH indicator appears in the upper right hand corner of the display.

See Figure 10

2. Rinse the pH electrode thoroughly with de-ionized water or a rinse solution. Do not wipe the probe; this causes a build-up of electrostatic charge on the glass surface.
3. Dip the pH electrode into the standard calibration buffer (see page 10 for list of possible buffers). The end of the probe must be completely immersed into the sample. Stir the probe gently to create a homogeneous sample.

NOTE: The temperature element is in the conductivity/TDS cell. For temperature compensated readings, dip the conductivity/TDS cell into the calibration buffer as well.

4. Press CAL/MEAS to enter pH calibration mode. The CAL indicator lights. The primary display will show the measured reading while the smaller secondary display will indicate the pH standard buffer solution.

See Figure 11

5. Wait for the measured pH value to stabilize. If the READY indicator has been activated (set up program P3.1—see page 28), the READY annunciator lights when the reading is stable.
6. Press ENTER to confirm calibration. The meter is now calibrated to the current buffer. The lower display scrolls through the remaining buffer options.
 - If you are performing multipoint calibration, go to step 7.
 - If you are performing one-point calibration, go to step 9.
7. Rinse the electrode with de-ionized water or a rinse solution, and place it in the next pH buffer.
8. Follow steps 5 to 8 for additional calibration points.
9. When calibration is complete, press CAL/MEAS to return to pH measurement mode.

See Figure 12

Notes

To exit from pH Calibration mode without confirming calibration, DO NOT press ENTER in step 6. Press CAL/MEAS instead.

If the selected buffer value is not within ± 1.0 pH from the measured pH value: the electrode and buffer icon blink and the ERR annunciator appears in the lower left corner of the display.

To select USA or NIST buffer sets, see Set up Program P3.3 on page 29.

To limit the number of pH buffer values available during calibration, see Set up program P3.2 on page 28.

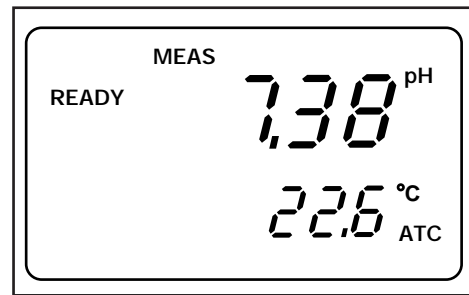

Figure 10

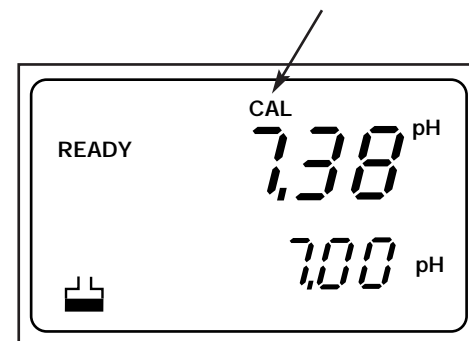

Figure 11

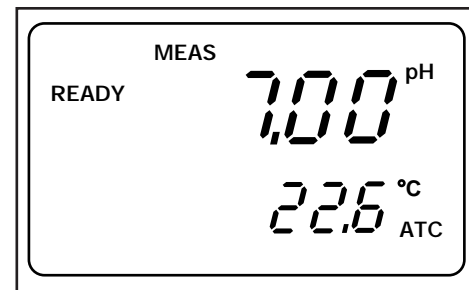

Figure 12

starting up
calibration
measurement
setup mode
electrode care
troubleshooting
specifications
accessories
appendixes
warranty
return of items

- starting up
- calibration
- measurement
- setup mode
- electrode care
- troubleshooting
- specifications
- accessories
- appendixes
- warranty
- return of items

Conductivity/TDS calibration

This meter is capable of up to 5-point conductivity or TDS calibration at one point per range:

Conductivity:	TDS:
0.00-19.99 μ S	0.00-9.99 ppm
0.0-199.9 μ S	10.0-99.9 ppm
0-1999 μ S	100-999 ppm
0.00-19.99 mS	1.00-9.99 ppt
0.0-199.9 mS	10.0-199.9 ppt

If you are measuring values in more than one range, make sure to calibrate each of the ranges you are measuring. All new calibration data will over-ride existing stored calibration data for each measuring range you calibrate.

- If you are measuring in ranges near to or greater than 20 mS (10 ppt), or near to or lower than 100 μ S (50 ppm), calibrate the meter at least once a week to get specified $\pm 1\%$ F.S. accuracy.
- If you are measuring in the mid ranges and you washed the probe in deionized water and stored it dry, calibrate the meter at least once a month.
- If you take measurements at extreme temperatures, calibrate the meter at least once a week.

Preparing for conductivity/TDS calibration

For best results, select a standard value close to the sample value you are measuring. Alternatively, use a calibration solution value that is approximately 2/3 the full scale value of the measurement range you plan to use. For example, in the 0 to 1999 μ S conductivity range, a 1413 μ S solution is a good solution for calibration.

See the table at left for recommended calibration solution ranges.

Temperature coefficient: These meters are factory set to a temperature coefficient of 2.1% per $^{\circ}$ C. For most applications this will provide good results. See Program P8.1 on page 36 to set the temperature coefficient to a different value.

See Appendix 2, "Calculating Temperature Coefficients" on page 45 to determine the appropriate temperature coefficient for your solution.

Normalization temperature: The factory default value for normalization temperature is 25 $^{\circ}$ C. If you need to normalize to a value other than 25 $^{\circ}$ C, see Program P8.2 on page 36.

TDS conversion factor: The factory default setting for the TDS conversion factor is 0.5. If your solution has a different TDS factor, you can improve calibration accuracy by setting the TDS factor prior to calibration. See Program P7.4 on page 35.

See Appendix 1, "Conductivity to TDS conversion Factors" on page 44 to determine your solution's TDS factor.

Conductivity / TDS Range	Recommended Calibration Solution Range
Conductivity	
0.00-19.99 μ S	6.00 to 17.00 μ S
0.0-199.9 μ S	60.0 to 170.0 μ S
0-1999 μ S	600 to 1700 μ S
TDS	
0.00-9.99 ppm	3.00 to 8.50 ppm
10.0-99.9 ppm	30.0 to 85.0 ppm
100-999 ppm	300 to 850 ppm
1.00-9.99 ppt	3.00 to 8.50 ppt
10.0-200 ppt	30.0 to 170 ppt

To calibrate conductivity or TDS:

1. If necessary, press the MODE key to select conductivity or TDS mode.

See Figure 13

2. Rinse the probe thoroughly with de-ionized water or a rinse solution, then rinse with a small amount of calibration standard.
3. Dip the probe into the calibration standard. Immerse the probe tip beyond the upper steel band. Stir the probe gently to create a homogeneous sample.

See Figure 14

4. Wait for the measured conductivity value to stabilize. If the READY indicator has been activated (Set up program P7.1—see page 33), the READY annunciator lights when the reading is stable.
5. Press CAL/MEAS to enter conductivity (TDS) calibration mode. The CAL indicator will appear in the upper right corner of the display.

See Figure 15

6. Press the ▲ or ▼ keys to change the value on the primary display to match the value of the calibration standard. The lower display will show the factory calibrated value.

See Figure 16

7. Press ENTER to confirm the calibration value. The meter returns to the MEAS (measurement) mode.
8. Repeat steps 1-7 for other ranges.

Notes

To exit from Conductivity (TDS) Calibration mode without confirming calibration, DO NOT press ENTER in step 7. Press CAL/MEAS instead. This will retain the meter's old calibration data in the measuring range of the calibration.

When entering calibration mode, the meter will display the factory default value. If the meter was previously calibrated, the display may "jump" to the factory default value when switching from measurement to calibration mode.

You can offset the conductivity or TDS reading up to $\pm 20\%$ from the default setting. If your measured value differs by more than $\pm 40\%$, clean or replace probe as needed.

See page 43 for a wide selection of high-quality calibration standards.

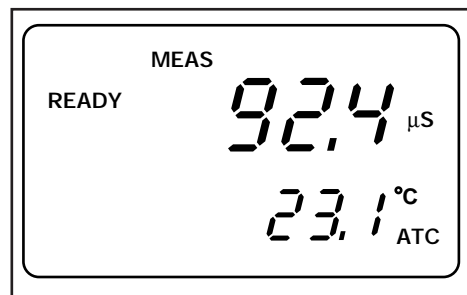

Figure 13

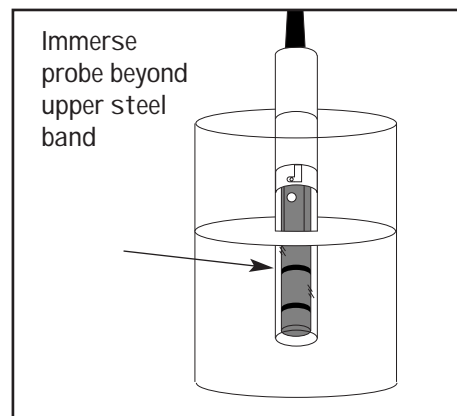

Figure 14

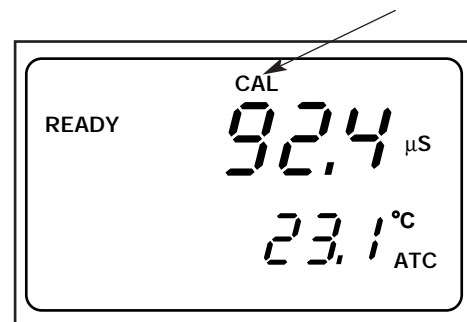

Figure 15

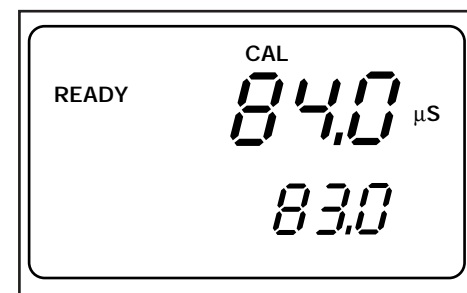

Figure 16

starting up

calibration

measurement

setup mode

electrode care

troubleshooting

specifications

accessories

appendixes

warranty

return of items

- starting up
- calibration
- measurement
- setup mode
- electrode care
- troubleshooting
- specifications
- accessories
- appendixes
- warranty
- return of items

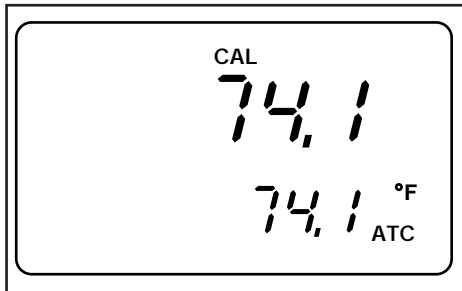

Figure 17

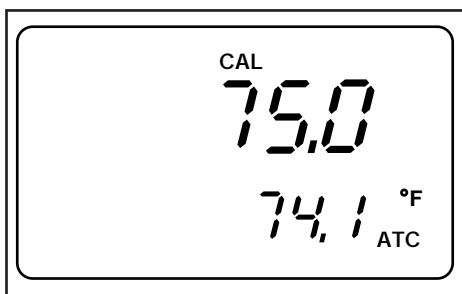

Figure 18

Temperature calibration

The temperature sensor (located in the conductivity/TDS cell) is factory calibrated. Calibrate your sensor only if you suspect sensor drift that may have occurred over a long period of time or if you have a replacement probe.

Temperature calibration

1. Make sure the conductivity/TDS cell (or alternative temperature element) is attached to the 6-pin connector.
2. Switch the meter on. The ATC annunciator will appear at the right-hand side of the LCD.
3. Press the CAL/MEAS key to enter calibration mode (either pH, conductivity or TDS). The CAL indicator will appear above the primary display.
4. While in calibration mode, press the MODE key to enter temperature calibration mode. The primary display shows the last set temperature value and the secondary display shows the temperature reading with zero offset.

See Figure 17

5. Dip the ATC element into a solution of known temperature (i.e. a temperature bath). Allow time for the temperature element to stabilize.
6. Scroll with the ▼ and ▲ keys to set the correct temperature value (i.e. the temperature of the temperature bath). You can adjust the reading in increments of 0.1°C.

See Figure 18

7. Once you have selected the correct temperature, press the ENTER key. The meter automatically returns to measurement mode.

Notes

- You can offset the temperature reading up to $\pm 5^{\circ}\text{C}$ from the original reading.
- To exit this program without confirming the temperature calibration value, DO NOT press ENTER in step 7. Press CAL/MEAS instead.

3. Measurement

Taking pH Measurements

To take readings:

1. Rinse the pH electrode with deionized or distilled water before use to remove any impurities adhering to the probe body. If the pH electrode has dehydrated, soak it for 30 minutes in electrode storage solution or a 2M–4M KCl solution.
2. Press ON to switch on meter.
3. Press the MODE key to select pH measurement mode. The MEAS annunciator appears on the top center of the LCD. The ATC indicator appears in the lower right hand corner to indicate Automatic Temperature Compensation.

See Figure 19

NOTE: For pH manual temperature compensation, you must disconnect the conductivity cell from the 6-pin connector. The ATC indicator will disappear from the display. You also need to set a manual temperature compensation value—see page 21 for directions.

4. Dip the pH electrode into the sample. Since the conductivity cell contains the temperature sensor, make sure it is also immersed in your solution.

When dipping the probe into the sample, the sensor or the glass bulb of the electrode must be completely immersed into the sample. Stir the probe gently in the sample to create a homogenous sample.

5. Allow time for the reading to stabilize. Note the reading on the display. If the Ready indicator is selected on, it will appear when the reading is stable. See page 18 for more information.
6. Press the MODE key to toggle between pH, mV, TDS and conductivity readings.

More information

- See page 18 for information on the HOLD function, READY indicator, and auto endpoint function.

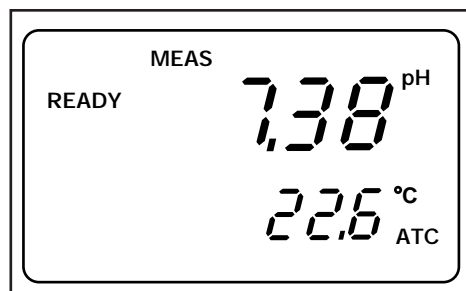

Figure 19

starting up

calibration

measurement

setup
mode

electrode
care

troubleshooting

specifications

accessories

appendixes

warranty

return of
items

More information

- See page 18 for information on the HOLD function, READY indicator, and auto endpoint function.

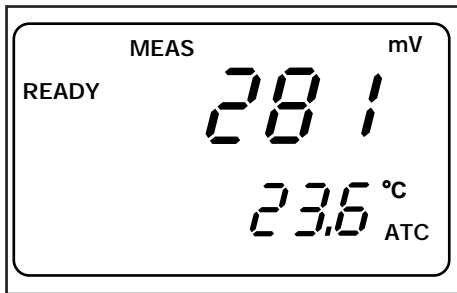

Figure 20

Taking mV Measurements

This meter can read mV measurements, which lets you take ORP or ion selective readings. It reads mV from a range of -600 to 600 mV.

You need to order an ORP or ion selective electrode with a BNC connector separately—see page 43 or contact your OAKTON distributor for information.

To take readings:

1. If necessary, press the MODE key to choose the mV mode.
2. Dip the electrode into the sample. The sensor or glass bulb of the electrode must be completely immersed into the sample. Stir the electrode gently to create a homogeneous sample.
3. Allow time for the reading to stabilize. Note the reading on the display. If the Ready indicator is selected on, it will appear when the reading is stable. See page 18 for more information.

See Figure 20

4. Press the MODE key to toggle between pH, mV, TDS and conductivity readings.

starting up

calibration

measurement

setup
mode

electrode
care

troubleshooting

specifications

accessories

appendixes

warranty

return of
items

Taking Conductivity or TDS Measurements

To take readings:

1. Rinse the probe with deionized or distilled water before use to remove any impurities adhering to the probe body. Shake or air dry. To avoid contamination or dilution of your sample, rinse probe with a small volume of your sample liquid.
2. Press ON to switch on meter.
3. Press the MODE key to select conductivity (TDS) measurement mode. The MEAS annunciator appears on the top center of the LCD.
 - Conductivity readings: display shows μS or mS
 - TDS readings: display shows ppm or pptThe ATC indicator appears in the lower right hand corner to indicate Automatic Temperature Compensation.

See Figure 21

NOTE: For conductivity or TDS manual temperature compensation, you must deactivate the temperature sensor built into the conductivity/TDS probe and set a manual temperature compensation value. The ATC indicator will disappear from the display. See pages 20-21 for directions.

4. Dip the probe into the sample.

When dipping the probe into the sample, the tip of the probe must be immersed above the second steel band. Stir the probe gently in the sample to create a homogenous sample.

See Figure 22

5. Allow time for the reading to stabilize. Note the reading on the display. If the Ready indicator is selected on, it will appear when the reading is stable. See page 18 for more information.
6. Press the MODE key to toggle between pH, mV, TDS and conductivity readings.

Notes

You can use the conductivity manual ranging function to select a specific range in which your readings will appear. See page 19 for directions.

More information

- See page 18 for information on the HOLD function, READY indicator, and auto endpoint function.

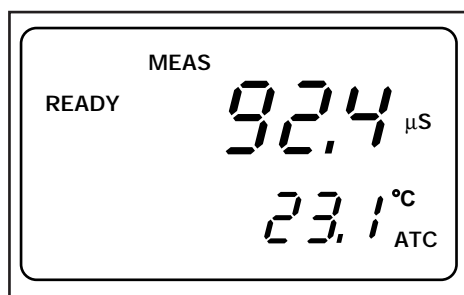

Figure 21

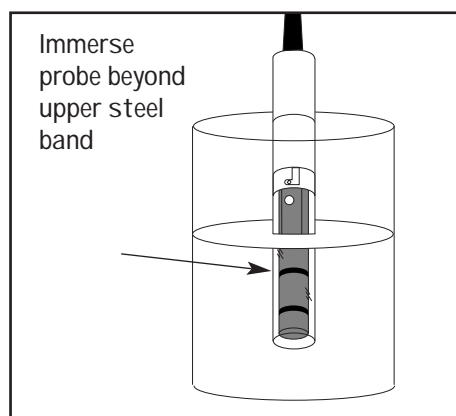

Figure 22

starting up

calibration

measurement

setup mode

electrode care

troubleshooting

specifications

accessories

appendixes

warranty

return of items

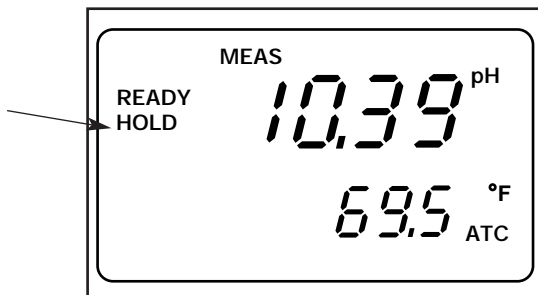

Figure 23

HOLD function

This feature lets you freeze your reading for a delayed observation. HOLD can be used any time when in MEAS mode.

1. To hold a measurement, press the HOLD key while in measurement mode. "HOLD" will appear on the display.

See figure 23

2. To release the held value, press HOLD again. Continue to take measurements.

Taking measurements with READY indicator selected on

If the READY indicator has been activated, the READY annunciator lights when the reading is stable. Switch the READY indicator on or off in Set up program P3.1—see page 28 for directions.

Taking measurements with the auto endpoint feature selected on

When a reading is stable for more than 5 seconds, the auto endpoint feature will automatically “hold” the reading. The “hold” indicator appears on the left side of the display. Press the HOLD key to release the reading. Switch the Auto endpoint feature on or off in Set up program P3.1—see page 28 for directions.

starting up

calibration

measurement

setup
mode

electrode
care

troubleshooting

specifications

accessories

appendixes

warranty

return of
items

Using manual ranging function: conductivity or TDS

When shipped from the factory, your meter automatically selects the range in which your readings appear. The manual ranging function lets you select the specific range in which you want to work.

From measurement mode:

1. To select the desired measuring range, press the RANGE key while in Conductivity (or TDS) measurement mode. The first range will appear on the display. The "MEAS" indicator blinks, and the "Range" number flashes briefly in the lower display.

	<u>conductivity</u>	<u>TDS</u>
r1 =	0.00-19.99 μ S	0.00-9.99 ppm
r2 =	0.0-199.9 μ S	10.0-99.9 ppm
r3 =	0-1999 μ S	100-999 ppm
r4 =	0.00-19.99 mS	1.00-9.99 ppt
r5 =	0.0-199.9 mS	10.0-199.9 ppt

See Figure 24

2. Press the RANGE key again (if needed) until desired range is selected.
3. To reselect the Auto-ranging function, repeatedly press the RANGE key until the "MEAS" indicator appears without blinking.

Notes

This meter will not let you manually select a range in which the reading will be overrange.

The meter resets to the Auto-ranging function once it is turned off. You will have reset the manual ranging function each time you turn the meter off.

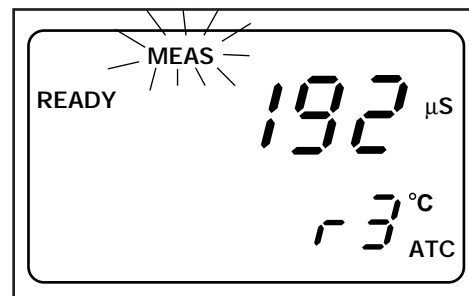

Figure 24

starting up
calibration
measurement
setup mode
electrode care
troubleshooting
specifications
accessories
appendixes
warranty
return of items

- starting up
- calibration
- measurement**
- setup mode
- electrode care
- troubleshooting
- specifications
- accessories
- appendixes
- warranty
- return of items

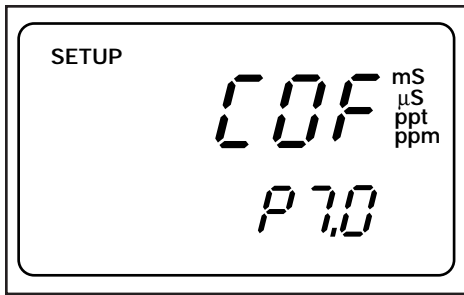

Figure 25

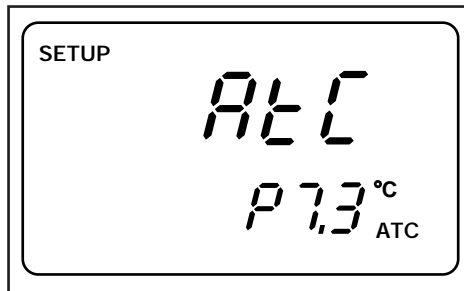

Figure 26

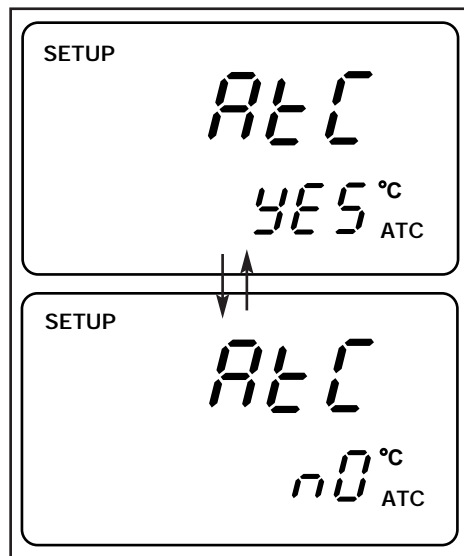

Figure 27

Selecting manual temperature compensation: conductivity or TDS

For manual temperature compensation in conductivity or TDS mode, you must:

1. Deactivate the temperature element built into the conductivity/TDS probe.
2. Select a manual temperature compensation value (see page 21).

You can deactivate the temperature element (select manual temperature compensation) in Set Up Program P7.3.

From measurement mode

1. Press the Mode key to select conductivity (or TDS) measurement mode.
2. Press the SET key to enter Set Up mode.
3. Press the ▲ or ▼ keys to scroll through subgroups until you view parameter P7.0.

See Figure 25

4. Press the ENTER key three times to select parameter 7.3. The upper display shows "ATC" and the lower display shows "P7.3".

See Figure 26

5. Press the ENTER key again. The upper display shows "ATC" and the lower display shows "YES" or "NO".
6. Press the ▲ and ▼ keys to select the Automatic Temperature Compensation off (NO).
 - YES = ATC on
 - NO = ATC off (manual compensation)

See Figure 27

7. Press the ENTER key to confirm selection and to return to the subgroup menu. Press the CAL/MEAS key twice to return to measurement mode.

Note that the ATC indicator no longer appears on the display.

Go to page 21 to select a manual temperature compensation value.

Selecting a manual temperature compensation value

To use manual temperature compensation, you need to enter the temperature value of your process into the meter. This is the value at which readings will manually temperature compensate. You can select any temperature between 0 and 100°C (32 and 212°F). Default value is 25°C (77°F).

To select a manual temperature compensation value:

1. Press the MODE key to select the measurement mode in which you need to use manual temperature compensation.
2. If necessary, select ATC off.
pH: see NOTE on page 15
Conductivity or TDS: see page 20
When ATC is off, the ATC indicator disappears from the lower right corner of the display.
3. Press the CAL/MEAS key to enter calibration mode. The CAL indicator will appear above the primary display.

See Figure 28

4. While in calibration mode, press the MODE key to enter temperature calibration mode. The primary display shows the current temperature setting and the secondary display shows the last set temperature value.

See Figure 29

5. Check the temperature of your sample using an accurate thermometer.
6. Press the ▲ or ▼ keys to offset the temperature to the measured value from step 5.

See Figure 30

7. Press ENTER to confirm the selected temperature and to return to measurement mode.

The meter will now compensate readings for the manually set temperature.

Notes

To exit this program without confirming the manual temperature compensation value, DO NOT press ENTER in step 7. Press CAL/MEAS instead.

Setting the manual temperature compensation value for conductivity or TDS will change the manual temperature compensation value for pH to the same value, and vice versa.

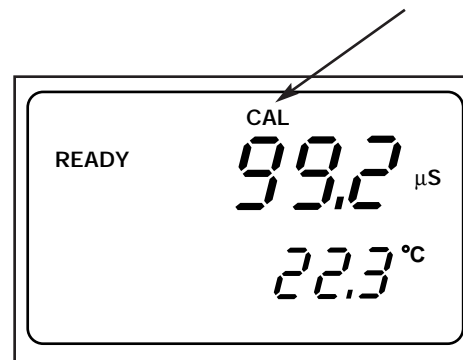

Figure 28

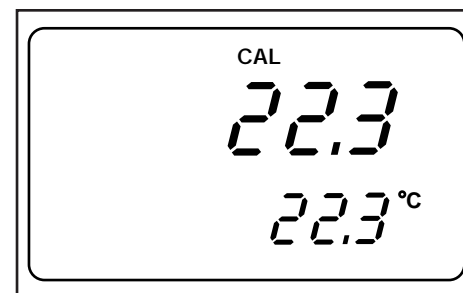

Figure 29

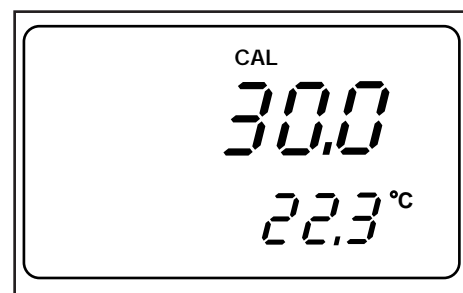

Figure 30

starting up
calibration
measurement
setup mode
electrode care
troubleshooting
specifications
accessories
appendixes
warranty
return of items

starting up

calibration

measurement

setup
mode

electrode
care

troubleshooting

specifications

accessories

appendixes

warranty

return of
items

Set up Mode

The Set up mode lets you customize your meter's preferences and defaults. Your OAKTON meter features different sub groups that organize all Set up parameters.

This meter blanks out sub groups that do not apply to the measurement mode [conductivity/TDS or pH] you are in when you enter Set up mode.

The full selection of available sub groups are:

pH sub groups

1. P1.0: Viewing pH calibration data
2. P2.0: Viewing pH probe data
3. P3.0: pH configuration
4. P4.0: Resetting meter to factory default (pH settings)

Conductivity/TDS sub groups

5. P5.0: Viewing conductivity or TDS calibration data
6. P6.0: Viewing conductivity or TDS probe data
7. P7.0: Conductivity or TDS configuration
8. P8.0: Conductivity or TDS temperature parameters
9. P9.0: Resetting meter to factory default (conductivity or TDS settings)

See pages 24-25 for a more detailed overview on the different parameters available in the sub group modes.

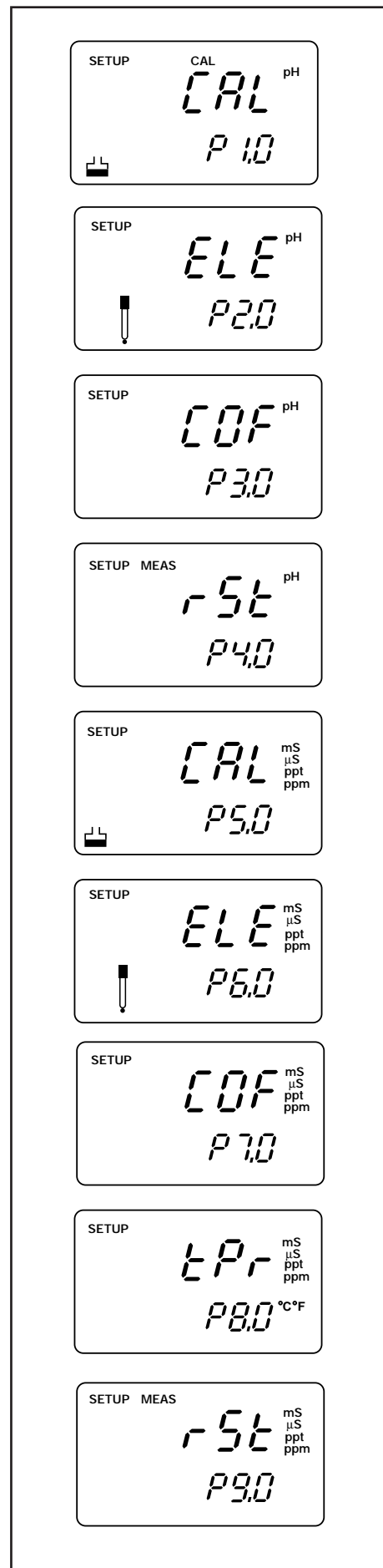

- starting up
- calibration
- measurement
- setup mode**
- electrode care
- troubleshooting
- specifications
- accessories
- appendixes
- warranty
- return of items

Set up mode overview

Press the SET key to enter Set up mode. Press the ▲ and ▼ keys to scroll through sub groups.

Sub groups available from pH measurement mode:

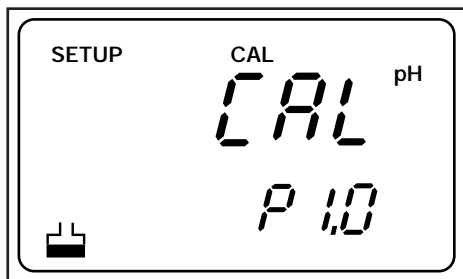

P1.0: Viewing pH calibration data

- P1.1 View previous pH calibration data (pH 1.68)
- P1.2 View previous pH calibration data (pH 4.01)
- P1.3 View previous pH calibration data (pH 7.00 or 6.86)
- P1.4 View previous pH calibration data (pH 10.01 or 9.18)
- P1.5 View previous pH calibration data (pH 12.45)

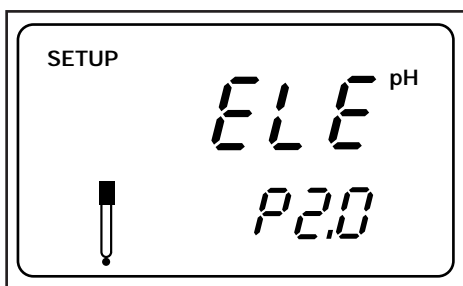

P2.0: Viewing pH electrode data

- P2.1 View electrode offset
- P2.2 View electrode slope

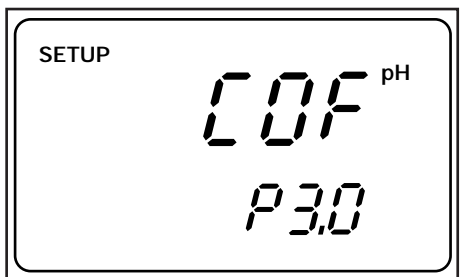

P3.0: pH configuration

- P3.1 Ready indicator on or off / auto endpoint on or off
- P3.2 Select number of pH calibration points
- P3.3 Select NIST or USA buffer sets
- P3.3 Select °F or °C

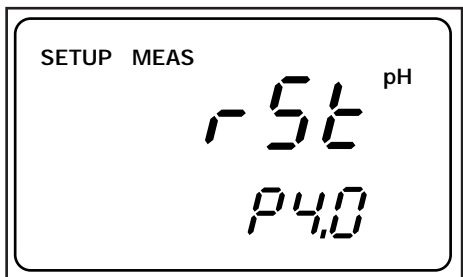

P4.0: Reset to factory default (pH)

Reset pH data to factory default settings

starting up

calibration

measurement

set up
mode

electrode
care

troubleshooting

specifications

accessories

appendixes

warranty

return of
items

Sub groups available from conductivity or TDS measurement mode:

P5.0: Viewing conductivity or TDS calibration data

P5.1 View conductivity/TDS calibration data R1

R1 = 0.00-19.99 μ S / 0.00-9.99 ppm

P5.2 View conductivity/TDS calibration data R2

R2 = 0.0-199.9 μ S / 10.0-99.9 ppm

P5.3 View conductivity/TDS calibration data R3

R3 = 0-1999 μ S / 100-999 ppm

P5.4 View conductivity/TDS calibration data R4

R4 = 0.00-19.99 mS / 1.00-9.99 ppt

P5.5 View conductivity/TDS calibration data R5

R5 = 0.0-199.9 mS / 10.0-199.9 ppt

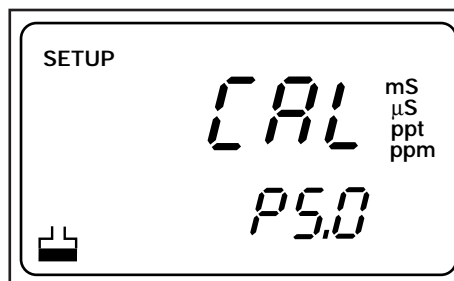

P6.0: Viewing conductivity or TDS probe data

P6.1 View effective cell constant R1

R1 = 0.00-19.99 μ S / 0.00-9.99 ppm

P6.2 View effective cell constant R2

R2 = 0.0-199.9 μ S / 10.0-99.9 ppm

P6.3 View effective cell constant R3

R3 = 0-1999 μ S / 100-999 ppm

P6.4 View effective cell constant R4

R4 = 0.00-19.99 mS / 1.00-9.99 ppt

P6.5 View effective cell constant R5

R5 = 0.0-199.9 mS / 10.0-199.9 ppt

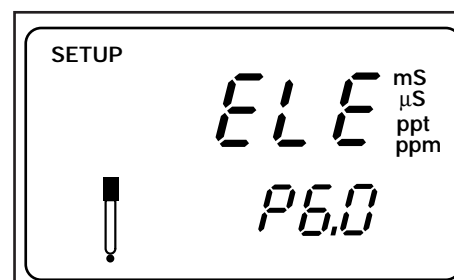

P7.0: Conductivity or TDS configuration

P7.1 Ready indicator on or off / auto endpoint on or off

P7.2 Select °F or °C

P7.3 Select Automatic or Manual Temperature Compensation

P7.4 Set Conductivity-to-TDS conversion factor

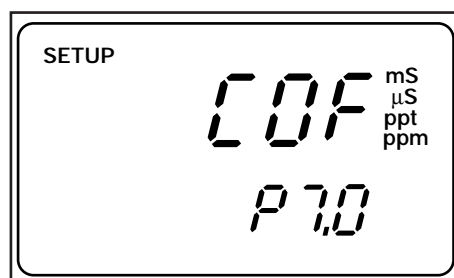

P8.0: Temperature parameters

P8.1 Set temperature coefficient

P8.2 Set normalization temperature

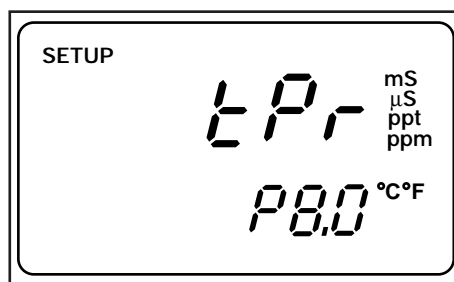

P9.0: Reset to factory default (conductivity or TDS)

Reset conductivity data to factory default settings

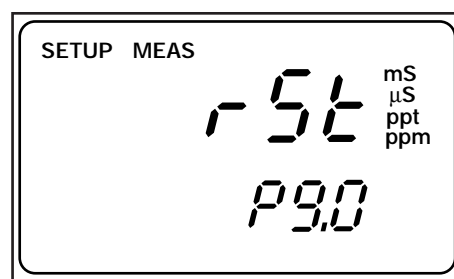

starting up

calibration

measurement

set up
mode

electrode
care

troubleshooting

specifications

accessories

appendixes

warranty

return of
items

- starting up
- calibration
- measurement
- set up mode
- electrode care
- troubleshooting
- specifications
- accessories
- appendixes
- warranty
- return of items

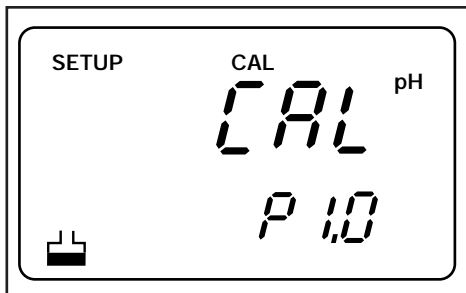

Figure 31

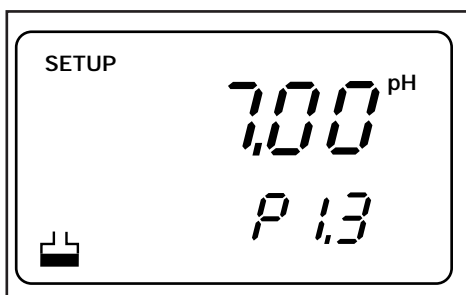

Figure 32

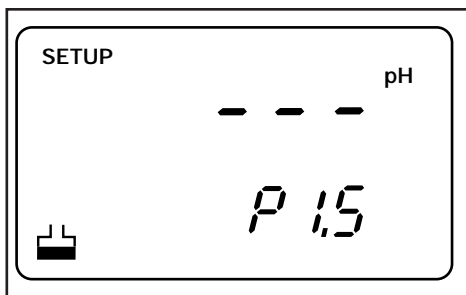

Figure 33

P1.0: Viewing previous pH calibration data

This mode lets you recall previous pH calibration data, which lets you know at which points this meter was previously calibrated. This is a “view only” mode.

From measurement mode:

1. Press the Mode key to select pH measurement mode.
2. Press the SET key to enter Set Up mode.

See Figure 31

3. Press the ▲ and ▼ keys to scroll through subgroups until you view parameter P1.0.

4. Press the ENTER key repeatedly to view previous calibration data.

USA buffers NIST buffers

P1.1 =	pH 1.68	pH 1.68
P1.2 =	pH 4.01	pH 4.01
P1.3 =	pH 7.00	pH 6.86
P1.4 =	pH 10.01	pH 9.18
P1.5 =	pH 12.45	pH 12.45

See Figure 32

5. When you have scrolled through all calibration data, you will automatically return to the subgroup menu. Press the CAL/MEAS key to return to measurement mode.

Notes

If there is no previous calibration data at a particular point, the primary display will show “---”.

See Figure 33

You can select USA or NIST buffer sets in P 3.3, page 29.

P2.0: Viewing pH electrode data

Program 2 has two “view only” options that lets you check the pH electrode parameters for diagnostic purposes. It lets you view:

P2.1: Electrode offset

P2.2 Electrode slope

From measurement mode

1. Press the Mode key to select pH measurement mode.
2. Press the SET key to enter Set Up mode.
3. Press the ▲ and ▼ keys to scroll through subgroups until you view parameter P2.0.

See Figure 34

4. Press the ENTER key to select parameter P2.1.
5. The display shows the electrode offset value (the mV offset at pH 7.00). If you have not calibrated at any buffer, the primary display shows 0.00 mV.

See Figure 35

6. Press the ENTER key to select parameter P2.2.
7. The display shows electrode slope in percentage. Slope displayed is the average slope based on the pH calibrations. Default setting is 100.0.

See Figure 36

8. Press the ENTER key to return to the subgroup menu. Press the CAL/MEAS key to return to measurement mode.

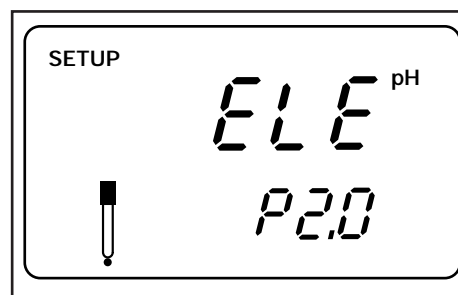

Figure 34

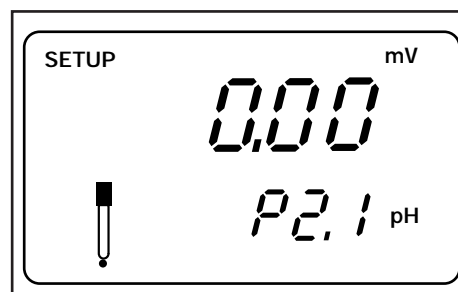

Figure 35

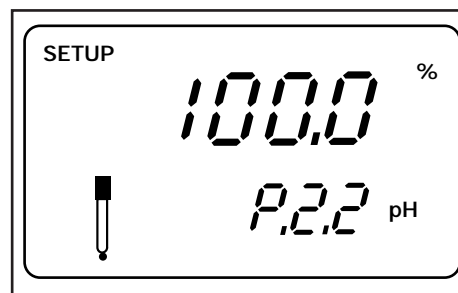

Figure 36

starting up
calibration
measurement
set up mode
electrode care
troubleshooting
specifications
accessories
appendixes
warranty
return of items

Definitions

READY indicator on indicates when reading is stable.

READY indicator off gives faster meter response.

Auto endpoint function on "holds" reading when it is stable for more than 5 seconds. The display automatically freezes, and the HOLD indicator appears on the display's left side. Press HOLD to release display and access other functions.

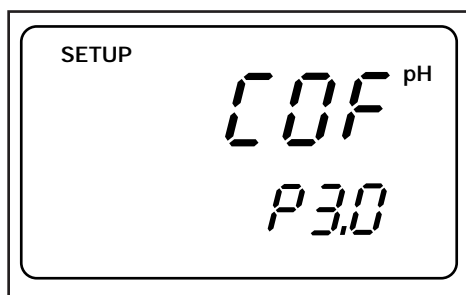

Figure 37

starting up

calibration

measurement

set up mode

electrode care

troubleshooting

specifications

accessories

appendixes

warranty

return of items

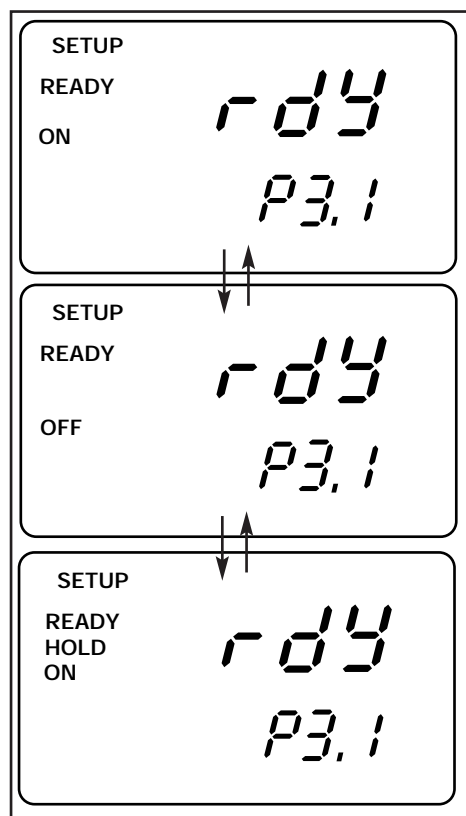

Figure 38

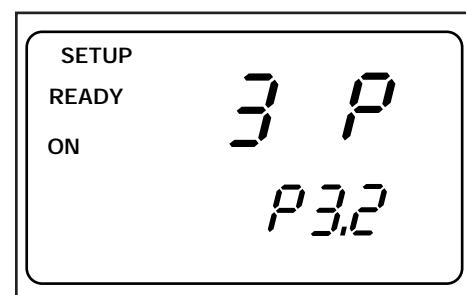

Figure 39

P3.0: pH configuration

P3.1: READY indicator and auto endpoint function

This program lets you select READY indicator on, READY indicator off, or Auto endpoint function on.

From measurement mode

1. Press the Mode key to select pH measurement mode.
2. Press SET key to enter Set Up mode.
3. Press the ▲ and ▼ keys to scroll through subgroups until you view parameter P3.0.

See Figure 37

4. Press the ENTER key to select parameter 3.1.

See Figure 38

5. Press the ▲ and ▼ keys to select the configuration:
 - OFF switches the READY indicator off.
 - ON switches the READY indicator on (meter default).
 - ON and HOLD together switches auto endpoint on.

6. Press the ENTER key to confirm selection and to proceed to step 5 of P.3.2. Press the CAL/MEAS key twice to return to measurement mode.

Notes

You can also change the Ready indicator and auto endpoint function in Program P7.1 (available from conductivity/TDS mode). Any changes you make to the Ready indicator/ auto endpoint function in pH mode will also change in conductivity/TDS mode.

P3.2: Selecting number of pH calibration points

Program P3.2 lets you select the number of pH calibration points the meter will use in calibration mode: 2, 3, 4, or 5. The meter will automatically exit calibration mode after you have calibrated to your selected number of points.

From measurement mode

1. Press the Mode key to select pH measurement mode.
2. Press SET key to enter Set Up mode.
3. Press the ▲ and ▼ keys to scroll through subgroups until you view parameter P3.0.

See Figure 37

4. Press the ENTER key twice to select parameter 3.2.

See Figure 39

5. Press the ▲ and ▼ keys to select 2, 3, 4, or 5 point pH calibration.
6. Press the ENTER key to confirm selection and to return to step 5 of P3.3. Press the CAL/MEAS key twice to return to measurement mode.

P3.3: Selecting NIST or USA buffer sets

Program P3.3 lets you select between the following calibration buffer sets:

USA: pH 1.68, 4.01, 7.00, 10.01, 12.45

NIST: pH 1.68, 4.01, 6.86, 9.18, 12.45

Factory default is the USA buffer set.

From measurement mode

1. Press the Mode key to select pH measurement mode.
2. Press SET key to enter Set Up mode.
3. Press the ▲ and ▼ keys to scroll through subgroups until you view parameter P3.0.

See Figure 37

4. Press the ENTER key three times to select parameter 3.3.

See Figure 40

5. Press the ▲ and ▼ keys to toggle between USA and NIST buffer sets.
6. Press the ENTER key to confirm selection and to proceed to step 5 of P.3.4. Press the CAL/MEAS key to return to measurement mode.

P3.4 Selecting °C or °F

This meter lets you select between °C and °F units for temperature readings. Factory default is °C.

From measurement mode

1. Press the Mode key to select pH measurement mode.
2. Press SET key to enter Set Up mode.
3. Press the ▲ and ▼ keys to scroll through subgroups until you view parameter P3.0.

See Figure 37

4. Press the ENTER key four times to select parameter 3.4.

See Figure 41

5. Press the ▲ and ▼ keys to toggle between °C and °F.
6. Press the ENTER key to confirm selection and to return to the subgroup menu. Press the CAL/MEAS key to return to measurement mode.

Notes

You can also switch between °C and °F in Program P7.2 (available from conductivity/TDS mode). If you switch between °C and °F in pH mode, the meter will also switch in conductivity/TDS mode.

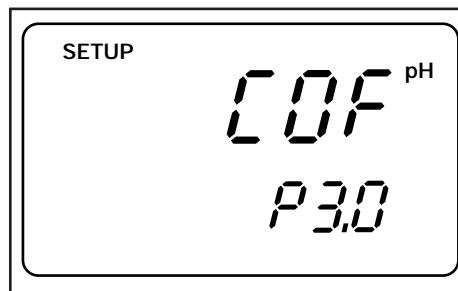

Figure 37

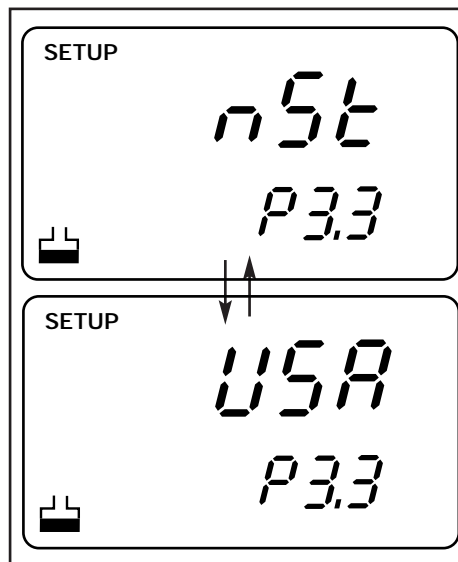

Figure 40

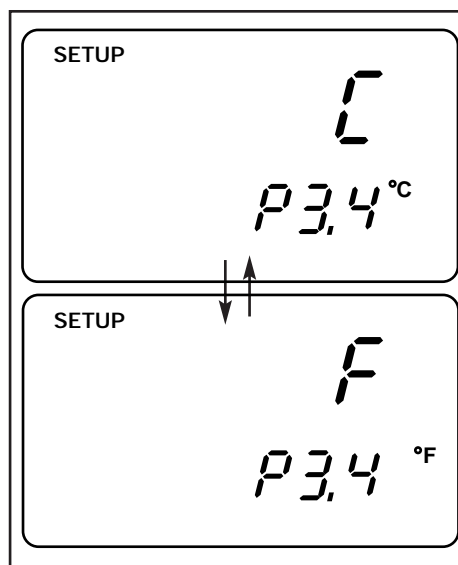

Figure 41

starting up
calibration
measurement
set up mode
electrode care
troubleshooting
specifications
accessories
appendixes
warranty
return of items

- starting up
- calibration
- measurement
- set up mode
- electrode care
- troubleshooting
- specifications
- accessories
- appendixes
- warranty
- return of items

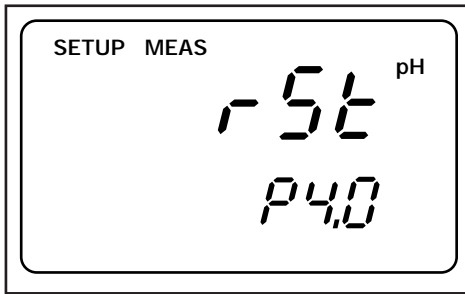

Figure 42

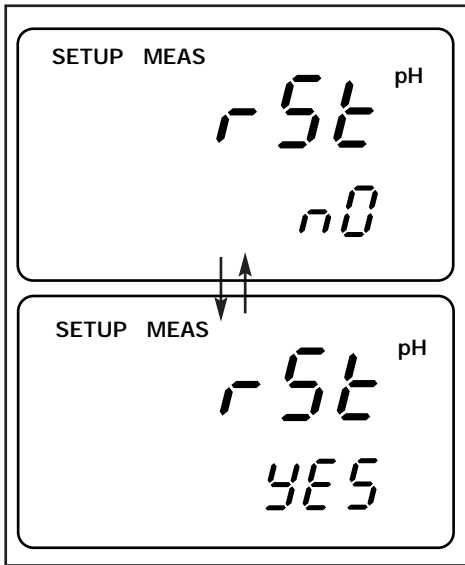

Figure 43

P4.0: Resetting to factory default settings (pH)

This program lets you reset all pH parameters to factory default settings. This clears all calibration data any other pH set up functions you might have changed. The following settings will remain as you have set them:

- temperature unit of measure (°C or °F)
- The temperature offset calibration value
- All conductivity (TDS) calibration data and parameters

From measurement mode

1. Press the Mode key to select pH measurement mode.
2. Press the SET key to enter Set Up mode.
3. Press the ▲ and ▼ keys to scroll through subgroups until you view parameter "P4.0" in the lower display.

See Figure 42

4. Press the ENTER key.

See Figure 43

5. Press the ▲ and ▼ keys to toggle between NO and YES.
 - NO retains current settings
 - YES resets to factory default settings

6. Press the ENTER key to confirm selection and to return to measurement mode.

Notes

To reset all conductivity/TDS data, see page 37.

See page 47 for a table of factory default settings.

P5.0: Viewing previous conductivity (TDS) calibration data

This mode lets you recall previous conductivity or TDS calibration data, which lets you know at which points this meter was previously calibrated. This is a “view only” mode.

From measurement mode:

1. Press the Mode key to select conductivity (TDS) measurement mode.
2. Press the SET key to enter Set Up mode.
3. Press the ▲ and ▼ keys to scroll through subgroups until you view parameter P5.0.

See Figure 44

4. Press the ENTER key repeatedly to view previous calibration data.

	<u>conductivity</u>	<u>TDS</u>
P5.1 (Range 1) =	0.00-19.99 μ S	0.00-9.99 ppm
P5.2 (Range 2) =	0.0-199.9 μ S	10.0-99.9 ppm
P5.3 (Range 3) =	0-1999 μ S	100-999 ppm
P5.4 (Range 4)=	0.00-19.99 mS	1.00-9.99 ppt
P5.5 (Range 5)=	0.0-199.9 mS	10.0-199.9 ppt

See Figure 45

5. When you have scrolled through all calibration data, you will automatically return to the subgroup menu. Press the CAL/MEAS key to return to measurement mode.

Notes

If there is no previous calibration data at a particular point, the primary display will show “- - -”.

See Figure 46

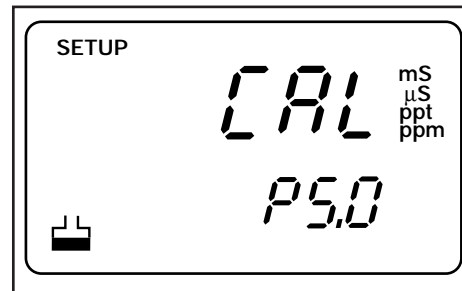

Figure 44

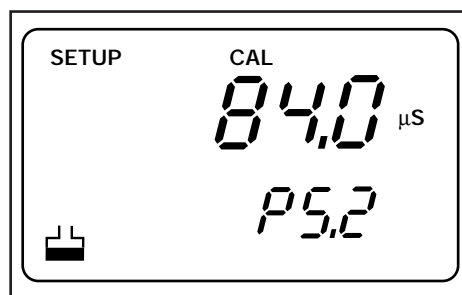

Figure 45

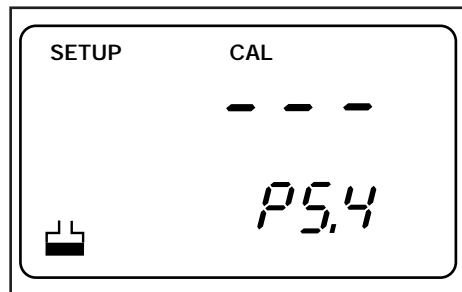

Figure 46

- starting up
- calibration
- measurement
- set up mode
- electrode care
- troubleshooting
- specifications
- accessories
- appendixes
- warranty
- return of items

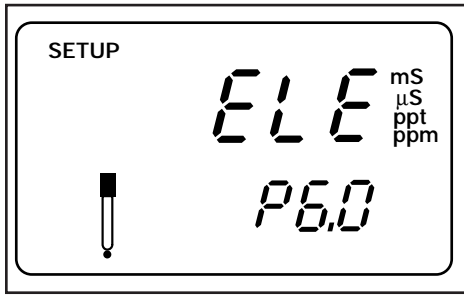

Figure 47

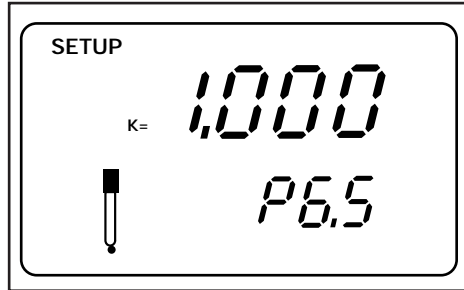

Figure 48

P6.0: Viewing conductivity (TDS) probe data

Program 6 has five "view only" options that let you check your conductivity/TDS probe's parameters for diagnostic purposes. These options show you the effective cell constant for each range. The cell constant is adjusted according to your calibration.

From measurement mode:

1. Press the Mode key to select conductivity (TDS) measurement mode.
2. Press the SET key to enter Set Up mode.
3. Press the ▲ and ▼ keys to scroll through subgroups until you view parameter P6.0.

See Figure 47

4. Press the ENTER key repeatedly to view the effective cell constant for each range.

	<u>conductivity</u>	<u>TDS</u>
P6.1 (Range 1) =	0.00-19.99 µS	0.00-9.99 ppm
P6.2 (Range 2) =	0.0-199.9 µS	10.0-99.9 ppm
P6.3 (Range 3) =	0-1999 µS	100-999 ppm
P6.4 (Range 4)=	0.00-19.99 mS	1.00-9.99 ppt
P6.5 (Range 5)=	0.0-199.9 mS	10.0-199.9 ppt

See Figure 48

5. When you have scrolled through all probe data, you will automatically return to the subgroup menu. Press the CAL/MEAS key to return to measurement mode.

Notes

Cell constants will degrade with time and usage. You can use this feature to alert you to when your probe needs cleaning or to when you need to replace your probe.

starting up

calibration

measurement

set up mode

electrode care

troubleshooting

specifications

accessories

appendixes

warranty

return of items

P7.0: Conductivity (TDS) configuration

P7.1: READY indicator and auto endpoint function

This program lets you select READY indicator on, READY indicator off, or Auto endpoint function on.

READY indicator on indicates when reading is stable.

READY indicator off gives faster meter response.

Auto endpoint function on "holds" reading when it is stable for more than 5 seconds. The display automatically freezes, and the HOLD indicator appears on the display's left side. Press HOLD to release display and access other functions.

From measurement mode

1. Press the Mode key to select conductivity (TDS) measurement mode.
2. Press SET key to enter Set Up mode.
3. Press the ▲ and ▼ keys to scroll through subgroups until you view parameter P7.0.

See figure 49

4. Press the ENTER key to select parameter 7.1.

See figure 50

5. Press the ▲ and ▼ keys to select the configuration:
 - OFF switches the READY indicator off.
 - ON switches the READY indicator on (meter default).
 - ON and HOLD together switches auto endpoint on.
6. Press the ENTER key to confirm selection and to proceed to step 5 of P.7.2. Press the CAL/MEAS key twice to return to measurement mode.

Notes

You can also change the Ready indicator and auto endpoint function in Program P3.1 (available from pH mode). Any changes you make to the Ready indicator/ auto endpoint function in conductivity/TDS mode will also change in pH mode.

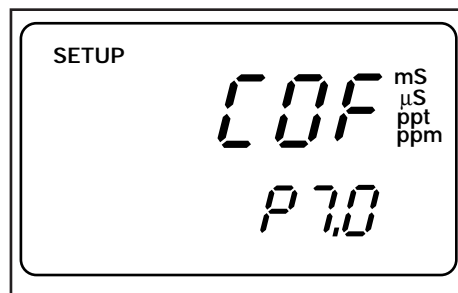

Figure 49

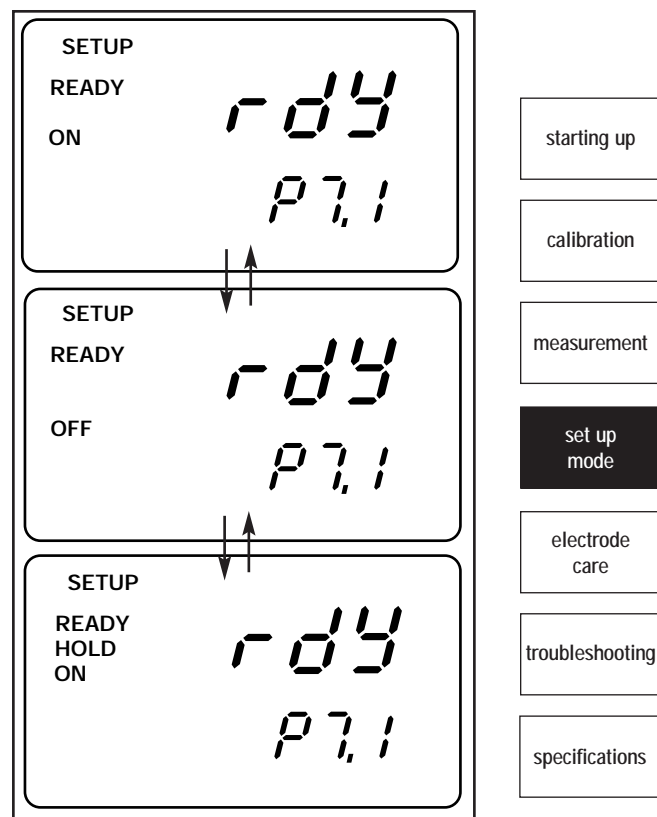

Figure 50

introduction

starting up

calibration

measurement

set up mode

electrode care

troubleshooting

specifications

accessories

appendixes

warranty

return of items

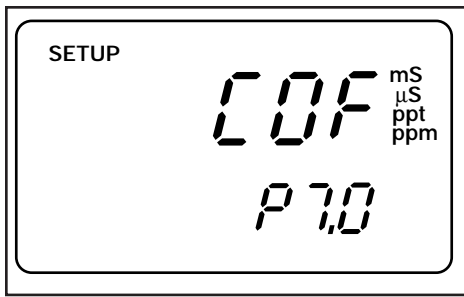

Figure 49

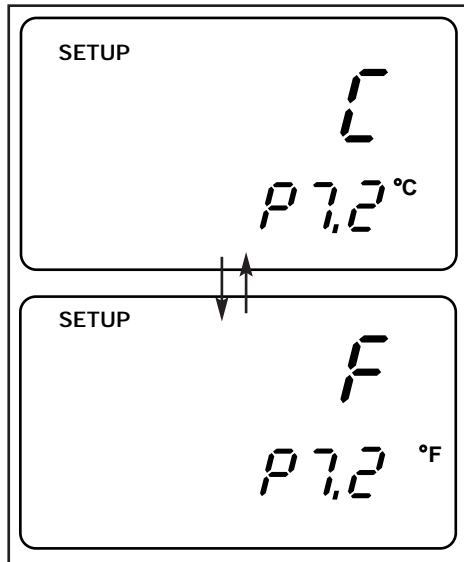

Figure 51

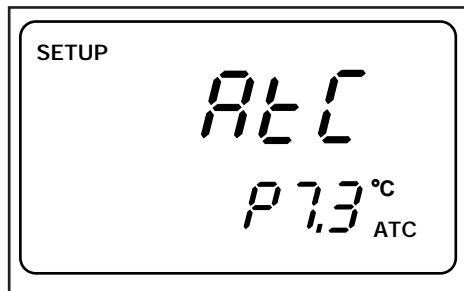

Figure 52

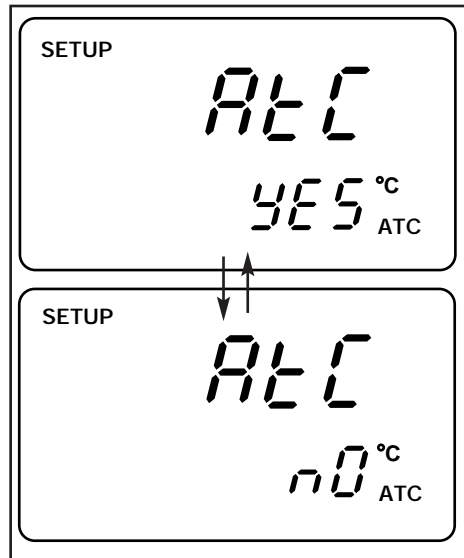

Figure 53

P7.2 Selecting °C or °F

This meter lets you select between °C and °F units for temperature readings.

From measurement mode

1. Press the Mode key to select conductivity (TDS) measurement mode.
2. Press SET key to enter Set Up mode.
3. Press the ▲ and ▼ keys to scroll through subgroups until you view parameter P7.0.

See Figure 49

4. Press the ENTER key two times to select parameter 7.2.

See Figure 51

5. Press the ▲ and ▼ keys to toggle between °C and °F.
6. Press the ENTER key to confirm selection and to proceed to step 5 of P.7.3. Press the CAL/MEAS key twice to return to measurement mode.

Notes

You can also switch between °C and °F in Program P3.2 (available from pH mode). If you switch between °C and °F in conductivity/TDS mode, the meter will also switch in pH mode.

P7.3 Selecting Automatic/Manual Temperature Compensation

This feature lets you select between Automatic Temperature Compensation (ATC) and Manual Temperature Compensation for conductivity (it lets you deactivate the temperature sensor in the conductivity probe). Meter default is ATC.

From measurement mode

1. Press the Mode key to select conductivity (TDS) measurement mode.
2. Press the SET key to enter Set Up mode.
3. Press the ▲ and ▼ keys to scroll through subgroups until you view parameter P7.0.

See Figure 49

4. Press the ENTER key three times to select parameter 7.3. The upper display shows "ATC" and the lower display shows "P7.3".

See Figure 52

5. Press the ENTER key again. The upper display shows "ATC" and the lower display shows "YES" or "NO".

See Figure 53

6. Press the ▲ and ▼ keys to select the Automatic Temperature Compensation on of off.
 - YES = ATC on
 - NO = ATC off (manual compensation)
7. Press the ENTER key to confirm selection and to proceed to step 5 of P7.4. Press the CAL/MEAS key twice to return to measurement mode.

P7.4 Setting the TDS factor

The concentration of salts dissolved in solution increases the conductivity of that solution. This relationship varies from salt to salt and is roughly linear over a given range for a given salt. The TDS conversion factor is the number used by the meter to convert from conductivity to TDS.

To determine the conductivity to TDS conversion factor for your solution, Appendix 1 on page 44 lists some commonly used conversion factors and describes how to calculate the TDS conversion factor for other solutions.

You can set the TDS conversion factor between 0.4 and 1.0; Meter default is 0.5.

From measurement mode

1. Press the Mode key to select conductivity (TDS) measurement mode.
2. Press the SET key to enter Set Up mode.
3. Press the ▲ and ▼ keys to scroll through subgroups until you view parameter P7.0.

See Figure 49

4. Press the ENTER key five times to select parameter 7.4. The upper display shows "tdS" and the lower display shows "P7.4".

See Figure 54

5. Press the ENTER key again. The upper display shows a value and the lower display shows "tdS".

See Figure 55

6. Calculate the TDS factor of your solution. See Appendix 1 on page 44 for information on how to calculate the TDS factor.
7. Press the ▲ and ▼ keys to select your calculated TDS conversion factor.
8. Press the ENTER key to confirm selection and to return to the subgroup menu. Press the CAL/MEAS key to return to measurement mode.

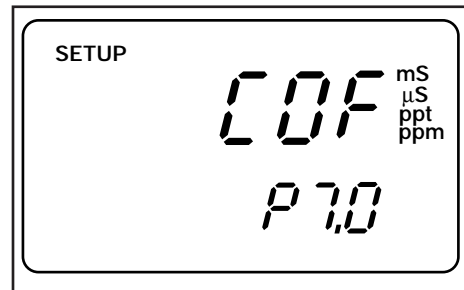

Figure 49

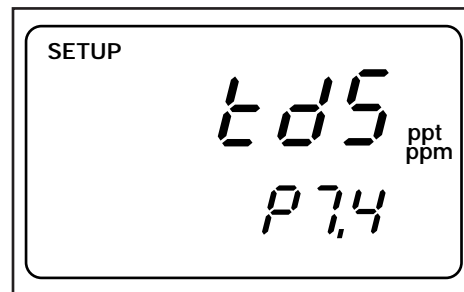

Figure 54

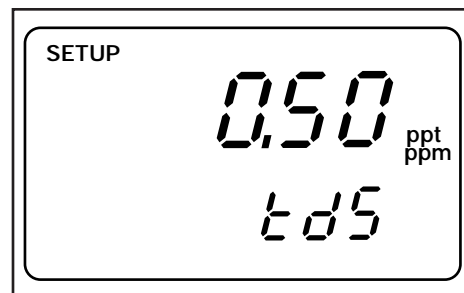

Figure 55

introduction

starting up

calibration

measurement

set up
mode

electrode
care

troubleshooting

specifications

accessories

appendixes

warranty

return of
items

- starting up
- calibration
- measurement
- set up mode
- electrode care
- troubleshooting
- specifications
- accessories
- appendixes
- warranty
- return of items

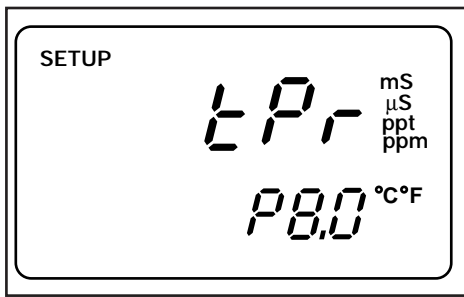

Figure 56

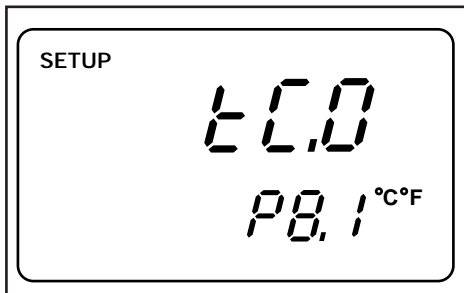

Figure 57

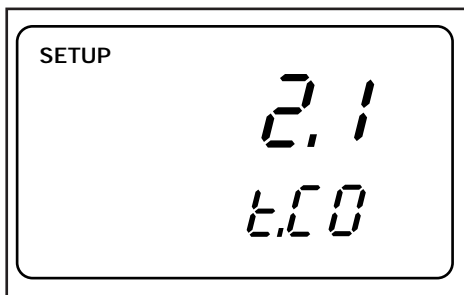

Figure 58

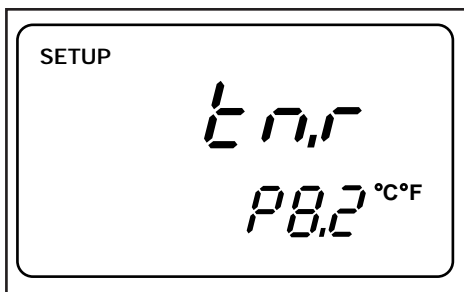

Figure 59

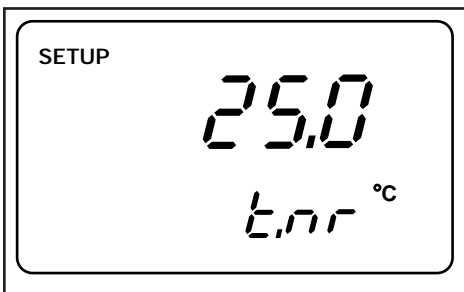

Figure 60

P8.0: Temperature Settings

P8.1 Selecting the temperature coefficient

The temperature coefficient is the amount of change in conductivity per degree of temperature. Entering the exact temperature coefficient of your solution lets you accurately compensate temperature for almost any solution. You can adjust 0.0 to 10.0% per °C or °F. Meter default is 2.1% per °C or °F.

Determine your solution's temperature coefficient using the formula in App. 3 "Calculating Temperature Coefficients", page 45.

From measurement mode

1. Press Mode to select conductivity/TDS measurement mode.
2. Press the SET key to enter Set Up mode.
3. Press the ▲ and ▼ keys to scroll through subgroups until you view parameter P8.0.

See Figure 56

4. Press the ENTER key to select parameter 8.1. The display shows "T.CO" on the upper display.

See Figure 57

5. Press the ENTER key again.. The upper display shows the temperature coefficient and the lower display shows "T.CO".

See Figure 58

6. Press the ▲ and ▼ keys to select the temperature coefficient of your solution.
7. Press the ENTER key to confirm selection and to proceed to step 5 of P8.2. Press the CAL/MEAS key twice to return to measurement mode.

P8.2 Selecting the normalization temperature

Your meter normalizes its conductivity (TDS) measurements to a standard temperature. You can adjust the normalization temperature from 15 to 30°C (59 to 86°F). Meter default is 25°C (77°F).

From measurement mode

1. Press Mode to select conductivity/TDS measurement mode.
2. Press the SET key to enter Set Up mode.
3. Press the ▲ and ▼ keys to scroll through subgroups until you view parameter P8.0.

See Figure 56

4. Press the ENTER key three times to select parameter 8.2. The display shows "t.nr" on the upper display.

See Figure 59

5. Press the ENTER key again. The upper display shows the normalization temperature and the lower display shows "t.nr".

See Figure 60

6. Press the ▲ and ▼ keys to select normalization temperature.
7. Press the ENTER key to confirm selection and to return to the subgroup menu. Press the CAL/MEAS key to return to measurement mode.

P9.0: Resetting to factory default settings (conductivity or TDS)

This program lets you reset all conductivity and/or TDS parameters to factory default settings. This clears all calibration data any other conductivity set up functions you might have changed. The following settings will remain as you have set them:

- temperature unit of measure (°C or °F)
- The temperature offset calibration value
- All pH calibration data and parameters

From measurement mode

1. Press the Mode key to select conductivity or TDS measurement mode.
2. Press the SET key to enter Set Up mode.
3. Press the ▲ and ▼ keys scroll through subgroups until you view parameter “P9.0” in the lower display.

See Figure 61

4. Press the ENTER key.

See Figure 62

5. Press the ▲ and ▼ keys to toggle between NO and YES.
 - NO retains current settings
 - YES resets to factory default settings
6. Press the ENTER key to confirm selection and to return to measurement mode.

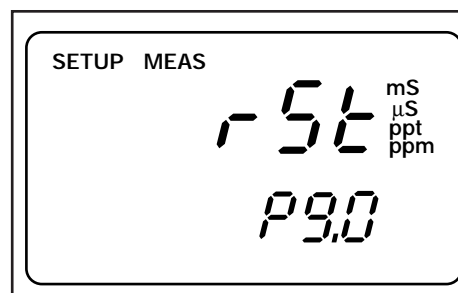

Figure 61

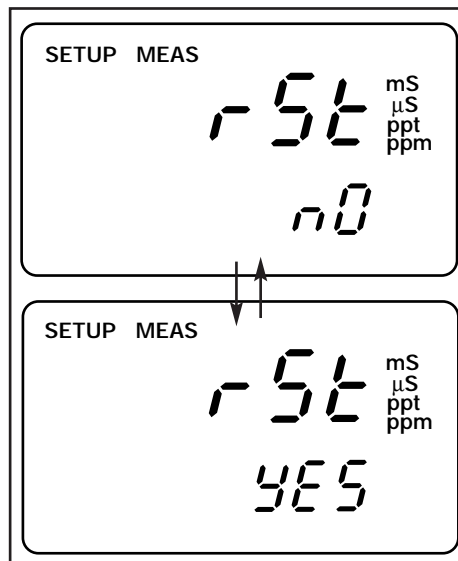

Figure 62

starting up
calibration
measurement
set up mode
electrode care
troubleshooting
specifications
accessories
appendixes
warranty
return of items

starting up

calibration

measurement

set up
mode

electrode
care

troubleshooting

specifications

accessories

appendixes

warranty

return of
items

9. Probe Care

Electrode Activation

DO NOT touch or rub the glass bulb. If you follow the storing and maintenance procedure, you can use your electrode immediately.

If the electrode responds sluggishly or drifts, the bulb may be dehydrated. Immerse the electrode in an ideal storage solution such as electrode storage solution or pH 4 buffer solution for 1-2 hours to hydrate it. See **Storing pH/ORP electrodes** below.

If this procedure does not hydrate the electrode, reactivate or replace it.

Use 2 or 3 point calibration to test your electrode performance. If you do not get good readings, use a different pH electrode to confirm the meter is working properly. If the results are still not satisfactory, consult your OAKTON distributor.

Electrode Maintenance

pH electrodes are susceptible to dirt dehydration and contamination. Clean them regularly depending on the extent and condition of use.

Storing pH/ORP electrodes

For best results, always keep the pH bulb wet, preferably in pH 4 buffer with 1% saturated KCl. Other pH buffers or tap water are also acceptable storage solutions. Do not store in de-ionized water. The protective rubber cap filled with buffer solution is an adequate method for storing pH electrodes.

OAKTON® offers a complete line of low cost electrode storage and cleaning solutions and containers.

After Use

1. After each series of measurements, wash the electrode and reference junction in deionized water.
2. If using a refillable electrode, close the refilling hole by returning its rubber sleeve or stopper plug over the opening in the side of the electrode.

See Figure 63.

3. Store the electrode as mentioned above.

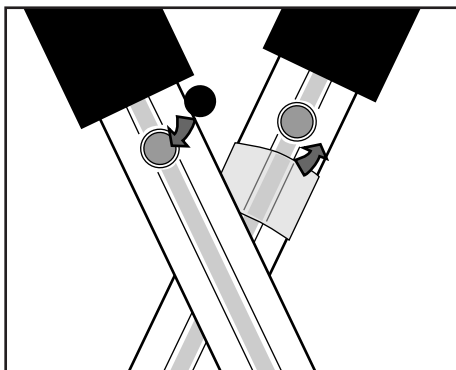

Figure 63

Electrode Cleaning

Electrodes that are mechanically intact can often be restored to normal performance by one or a combination of the following options.

Some suggestions for:

a. Salt deposits which are normal on all electrodes.

Dissolve the deposit by immersing the electrode in tap water for ten to fifteen minutes. Thoroughly rinse with de-ionized water.

b. General dirt and light oil coatings. Soak the electrode for several hours in OAKTON general purpose electrode cleaning solutions. Rinse in deionized or distilled water.

c. Oil/Grease Films

Wash the electrode pH bulb in a little dish washing detergent and water. Rinse the electrode tip with de-ionized water.

d. Clogged reference junction

Heat a dilute 1% KCl solution or pH 4.01 buffer solution to 60-80°C. Place the sensing portion of the pH electrode into the heated KCl solution for approximately 30 minutes. Allow the electrode to cool while immersed in some unheated KCl solution or pH 4.01 buffer solution. Rinse with deionized water.

Conductivity/TDS probe care

Keep the conductivity probe clean. Rinse the probe twice, and gently swirl it while you take readings. For best accuracy, soak a dry probe for at least 5 to 10 minutes or longer before calibration. Rinse the probe with deionized or tap water before storing. Never scratch the platinum portions with a hard substance. Do not strike the probe against any hard surface.

Do not make continuous contact with your solutions. Readings will rise over a period of time while you soak your probe.

Do not immerse the probe in oily solutions. Clean the electrode thoroughly by stirring it in a mild detergent bath or isopropyl alcohol. Wipe the probe with a soft tissue paper. Rinse thoroughly in tap water and then in deionized water. Recalibrate the meter after cleaning the probe.

The conductivity probe included with your meter features a removable probe guard to make cleaning easy.

To remove probe guard:

1. Grip yellow probe guard and twist clockwise. The locking notch will release.

See Figure 64.

2. Slide probe guard off end of probe.

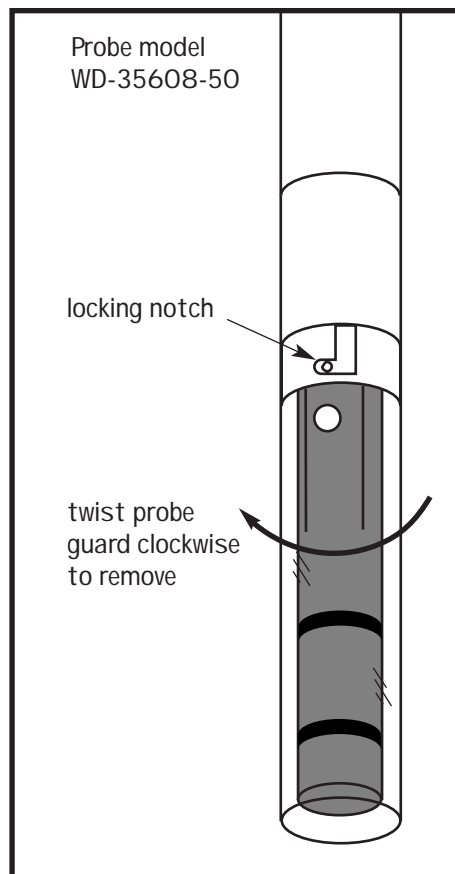

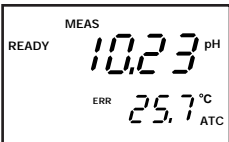
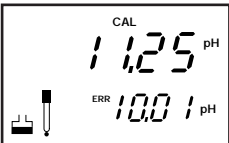

Figure 64

starting up
calibration
measurement
set up mode
electrode care
troubleshooting
specifications
accessories
appendixes
warranty
return of items

10. Troubleshooting

Error Messages

The following table provides a guideline to enable diagnosis of possible problems indicated by the messages generated by the OAKTON pH/CON 510 meter. The table also provides possible solutions to the problems encountered.

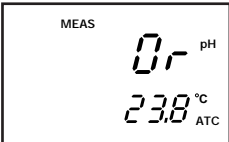
Error Message	Indicates	Cause	Corrective Action
<p>Err (In secondary display)</p> 	Wrong keypad input.	Button does not work in the current operation mode.	Release key. Select valid buttons depending on mode.
<p>Electrode icon (Indicator)</p> 	Calibration error	Buffer value does not match value displayed or electrode is disconnected or failing.	Use fresh buffer or check electrode connection. Possibly replace electrodes.
<p>Ur or Or (In primary display)</p>  	Measured value out of range	<p>Electrode not connected</p> <p>Meter not calibrated</p> <p>Electrode clogged, dirty or broken</p> <p>Measurement is under range or over range</p>	<p>Make sure electrode is connected</p> <p>Recalibrate meter</p> <p>Clean or replace electrode</p> <p>Treat samples to bring within meter measuring range</p>

starting up

calibration

measurement

set up
mode

electrode
care

troubleshooting

specifications

accessories

appendixes

warranty

return of
items

Troubleshooting

Problem	Cause	Solution
General Troubleshooting		
Nothing is displayed when the ON/OFF key is selected.	A. AC outlet power not switched on. B. AC adapter socket not inserted properly.	A. Switch on the power supply B. Re-insert AC adapter socket.
pH Troubleshooting		
Unstable reading	A. Insufficient reference electrolyte in electrode. B. Broken electrode. C. Electrical field interference (electrical noise caused by a nearby motor or ultrasonic device). D. Dirty probe	A. Fill electrode with reference electrolyte. B. Replace electrode. C. Remove or switch off interfering device. D. Clean the electrode. Hydrate if needed.
Slow response	A. Dirty probe	A. Clean electrode. Hydrate if needed.
No response from keypad.	A. HOLD mode in operation Hold displayed. See LCD. B. Internal program error.	A. Cancel HOLD mode. Press Hold button. B. Reset all internal programs by removing A/C adapter from meter and re-inserting
Conductivity/TDS Troubleshooting		
Unstable reading	A. Air bubbles in cell. B. Dirty probe. C. Low conductivity with solution. D. External noise pickup. E. Broken probe.	A. Tap cell to remove bubbles. B. Clean probe and recalibrate. C. Avoid atmospheric contact D. Move away from noise. E. Replace probe.
"OR" on upper display	A. Probe is shorted. B. Probe is in too-high conductivity solution for range.	A. Test probe. B. Use different solution or select different range.
Temperature reading erratic or lower display reads "OR"	A. Oxidation of temperature probe connector. B. Temperature of solution is out of range.	A. Clean connector with alcohol. B. Heat or cool solution.
Not able to calibrate	A. Dirty/Oily probe. B. Incorrect probe cell constant C. Contaminated or inaccurate standards	A. Clean probe. See "Probe Care & Maintenance" in instruction manual. B. Adjust for cell constant or replace probe. C. Replace standards

starting up

calibration

measurement

set up mode

electrode care

troubleshooting

specifications

accessories

appendixes

warranty

return of items

12. Specifications

Mode	pH	mV	Temperature	Conductivity	TDS
Range	-2.00 to 16.00 pH	-600 to +600 mV	0 to 100°C / 32.0 to 212°F	0 to 19.99 µS 0 to 199.9 µS 0 to 1999 µS 0 to 19.99 mS 0 to 199.9 mS	0.00 to 9.99 ppm 10.0 to 99.9 ppm 100 to 999 ppm 1.00 to 9.99 ppt 10.0 to 199.9 ppt
Resolution	0.01 pH	0.1 mV from ±199.9 mV; 1 mV beyond	0.1°C or °F	0.01 µS, 0.1 µS, 1 µS, 0.01 mS, 0.1 mS	0.01 ppm, 0.1 ppm, 1ppm, 0.01 ppt, 0.1 ppt
Accuracy	±0.01 pH	±0.2 mV from ±199.9 mV; ±2 mV beyond	±0.5°C / ±0.9°F	±1% full scale	±1% full scale
Calibration	up to 5 points (select USA or NIST buffer sets)	—	offset in 0.1° increments up to 5°	up to 5 points (one point per range)	up to 5 points (one point per range)

pH slope: 80 to 110%

Conductivity/TDS cell constant: fixed at K = 1.0

Conductivity/TDS temperature coefficient: adjustable from 0.0 to 10.0% per °C

Conductivity/TDS normalization temperature: adjustable from 15 to 30°C / 59 to 86°F

Temperature compensation: automatic or manual from 0 to 100°C / 32 to 212°F

Display: dual LCD

Operating temperature: 0 to 50°C / 32 to 122°F

Power: 9V DC adapter for 110 or 220 VAC

Probe connectors:

pH/mV: BNC connector

Conductivity/TDS/Temperature: notched six-pin connector

Dimensions:

Meter: 7.5"L x 3.5"W x 1.75"H (19.1 cm x 8.9 cm x 4.5 cm)

Boxed: 9.2"L x 9.2"W x 2.75"H (23 cm x 23 cm x 7 cm)

Probe: 6.8"L x 1.3" dia (17.3 cm L x 3.2 cm dia)

Weight:

Meter: 1.0 lb (0.5 kg)

Boxed: 2.0 lbs (0.9 kg)

starting up

calibration

measurement

set up mode

electrode care

troubleshooting

specifications

accessories

appendixes

warranty

return of items

13. Accessories

Meters

Each meter includes an electrode holder arm, AC adapter, and instructions. Three-year warranty on meters only.

WD-35610-12 pH/CON 510 meter only, 110 VAC

WD-35610-17 pH/CON 510 meter only, 220 VAC

WD-35610-10 pH/CON 510 meter, with single-junction pH electrode and conductivity/TDS/temp probe, 110 VAC

WD-35610-15 pH/CON 510 meter, with single-junction pH electrode and conductivity/TDS/temp probe, 220 VAC

Probes

WD-35801-00 Replacement pH electrode, BNC connector, epoxy body, single-junction, 3-ft cable

WD-35608-50 Replacement conductivity probe, notched 6-pin connector, built-in temperature element, K = 1.0, 3-ft cable

WD-35805-04 pH electrode, BNC connector, epoxy body, double junction, refillable, 3 ft cable

WD-35805-13 ORP electrode, BNC connector, epoxy body, single junction, 3 ft cable

WD-35618-05 Temperature probe with notched 6-pin connector

WD-35808-71 “All-in-One” combination pH/temperature probe, with BNC connector and notched 6-pin connector, single junction, sealed

WD-00653-04 Electrode storage solution, 1 pint bottle. Keeps electrode bulb moist for more accurate readings.

WD-00653-06 Electrode cleaning solution, 1 pint bottle. Removes electrode buildup; maintains electrode sensitivity.

OAKTON pH calibration solution bottles

pH solutions have ± 0.01 pH accuracy at 25°C. Shpg wt 1.1 lb.

WD-00654-01 pH 1.68 calibration buffer, 1 pint.

WD-00654-00 pH 4.01 calibration buffer, 1 pint.

WD-00654-04 pH 7.01 calibration buffer, 1 pint.

WD-00654-08 pH 10.01 calibration buffer, 1 pint.

WD-00654-12 pH 12.45 calibration buffer, 1 pint.

OAKTON “Singles” pH calibration solution pouches

pH solutions have ± 0.01 pH accuracy at 25°C. Shpg wt 1.1 lb per box of 20

WD-35653-01 pH 4.01 calibration buffer pouches

WD-35653-02 pH 7.00 Calibration buffer pouches

WD-35653-03 pH 10.00 Calibration buffer pouches

WD-35653-04 Assortment pack, 5 each deionized water, pH 4.01, pH 7.00, and pH 10.00 buffer pouches.

OAKTON conductivity/TDS calibration solution bottles

Our solutions come in 1 pint recyclable PE bottles. $\pm 1\%$ accuracy at 25°C.

Model No.	Solution type	Conductivity-to-TDS calibration values		
		ppm KCl	ppm NaCl	ppm 442
WD-00653-16	84 μ S	40.38	38.04	50.50
WD-00653-47	447 μ S	225.6	215.5	300.0
WD-00653-18	1413 μ S	744.7	702.1	1000
WD-00653-15	1500 μ S	757.1	737.1	1050
WD-00653-89	8974 μ S	5101	4487	7608
WD-00606-10	12,880 μ S	7447	7230	11,367
WD-00653-50	15,000 μ S	8759	8532	13,455
WD-00653-32	80 mS	52,168	48,384	79,688

OAKTON conductivity/TDS calibration solution pouches

Each pouch contains 20 ml of fresh, premixed calibration solution—guarantees uncontaminated solution for every use. $\pm 1\%$ accuracy at 25°C. 20 pouches/box. Shpg wt 1.1 lb (510 g).

Model No.	Solution type	Conductivity-to-TDS calibration values		
		ppm KCl	ppm NaCl	ppm 442
WD-35653-10	447 μ S	225.6	215.5	300.0
WD-35653-11	1413 μ S	744.7	702.1	1000
WD-35613-13	15,000 μ S	8759	8532	13,455

WD-35653-00 Deionized rinse water pouches. 20 pouches/box.

To order OAKTON accessories; contact your OAKTON distributor, or visit www.4oakton.com

starting up

calibration

measurement

set up mode

electrode care

troubleshooting

specifications

accessories

appendixes

warranty

return of items

Appendix 1: Conductivity to TDS Conversion Factors

- 1. Factor**—the conductivity to ppm TDS conversion factor. Multiply conductivity by this factor to get ppm TDS for the type of TDS reading needed.
- 2. 442**—a formulation that most closely represents the conductivity to ppm relationship, on average, for naturally occurring fresh water.
- 3. TDS Your Material**—These columns are for you to write in your application-specific conductivity-to-ppm values and conversion factors for future reference.

$$\text{Factor} = \text{actual TDS} \div \text{Actual Conductivity @ 25}^{\circ}\text{C}$$

Conductivity at 25°C	TDS KCl		TDS NaCl		TDS 442		TDS Your Material 3	
	ppm Value	Factor 1	ppm Value	Factor 1	ppm Value	Factor 1	ppm Value	Factor
84 µS	40.38	0.5048	38.04	0.4755	50.50	0.6563		
447 µS	225.6	0.5047	215.5	0.4822	300.0	0.6712		
1413 µS	744.7	0.5270	702.1	0.4969	1000	0.7078		
1500 µS	757.1	0.5047	737.1	0.4914	1050	0.7000		
8974 µS	5101	0.5685	4487	0.5000	7608	0.8478		
12880 µS	7447	0.5782	7230	0.5613	11,367	0.8825		
15000 µS	8759	0.5839	8532	0.5688	13,455	0.8970		
80 mS	52,168	0.6521	48,384	0.6048	79,688	0.9961		

- starting up
- calibration
- measurement
- set up mode
- electrode care
- troubleshooting
- specifications
- accessories
- appendixes
- warranty
- return of items

Calculating TDS Conversion Factors

You can calibrate your meter using TDS calibration standard solutions. The calibration standard only needs to give the TDS value at a standard temperature such as 25°C. To determine the conductivity-to-TDS conversion factor use the following formula:

$$\text{Factor} = \text{Actual TDS} \div \text{Actual Conductivity @ 25}^{\circ}\text{C}$$

Definitions:

Actual TDS: Value from the solution bottle label or as a standard you make using high purity water and precisely weighed salts.

Actual Conductivity: Value measured using a properly calibrated Conductivity/ Temperature meter.

Both the Actual TDS and the Actual Conductivity values must be in the same magnitude of units. For example, if the TDS value is in ppm the conductivity value must be in µS; if the TDS value is in ppt the conductivity value must be in mS.

Check your factor by multiplying the conductivity reading by the factor in the above formula. The result should be the TDS value.

Appendix 2: Calculating Temperature Coefficients

To determine the temperature coefficient of your sample solution use this formula:

$$TC = \frac{100 \times CT2 - CT1}{CT1(T2 - 25) - CT2(T1 - 25)}$$

TC = Temperature coefficient

CT1 = Conductivity at Temp. 1 CT2 = Conductivity at Temp. 2

T1 = Temp. 1 T2 = Temp. 2 25 = 25°C

NOTE: A controlled temperature water bath is ideal for this procedure.

1. Immerse the probe into a sample of your solution and adjust the temperature coefficient to 0% (that is, no compensation) by performing the following:
 - A. From conductivity measurement mode, press the SET key.
 - B. Press the ▲ key until the lower display reads P8.0.
 - C. Press the ENTER key twice. The lower display reads tCO and the upper display shows the temperature coefficient value.
 - D. Press the ▼ key until the upper display shows 0.0.
 - E. Press ENTER key to confirm the value.
 - F. Press CAL/MEAS key twice to return to measurement mode.
2. Wait for 5 minutes. Note T1 and CT1 (conductivity at T1).
3. Condition the sample solution and probe to a temperature (T2) that is about 5°C to 10°C different from T1, and note the conductivity reading CT2.

NOTE: Record your results for future reference. Ideally T1 and T2 should bracket your measurement temperature, and should not differ by more than 5°C.

4. Calculate the temperature coefficient of your solution according to the formula shown above.
5. Enter the temperature coefficient you calculated into the meter.
 - A. From conductivity measurement mode, press the SET key.
 - B. Press the ▲ key until the lower display reads P8.0.
 - C. Press the ENTER key twice. The lower display reads tCO and the upper display shows the temperature coefficient value (should be 0, per step 1-D above).
 - D. Press the ▲ key until the upper display shows your calculated temperature coefficient.
 - E. Press ENTER key to confirm the value.
 - F. Press CAL/MEAS key twice to return to measurement mode.

The calculated temperature coefficient will now be applied to all the meter readings.

starting up

calibration

measurement

set up
mode

electrode
care

troubleshooting

specifications

accessories

appendixes

warranty

return of
items

Appendix 3: pH and temperature

pH and Temperature

The pH electrode is affected by temperature changes. Automatic Temperature Compensation (ATC) compensates for temperature changes. Some solutions show an increase while others a decrease in pH with the same temperature change. Record the solution temperature along with the pH value, or the measurement may be meaningless. Temperature changes also affect the signal the pH electrode sends to the meter and causes a loss of accuracy for the reading. To limit the loss of accuracy during calibration, make the temperature of the pH buffer calibrating solutions and the sample solution the same.

pH Buffer Calibration Solution

Use standard buffer solutions to calibrate a pH meter before you measure the pH of a sample. Calibration solutions serve as basis of comparison between measurements. The most common standard buffers are the pH 4.01, pH 7.00 and pH 10.01, but this meter can let you calibrate as many as 5 points for highest accuracy over the entire range, or at very low or high pH levels.

For 1-point calibration, use a standard buffer of pH 7.00 or a standard buffer whose pH value is close to that of the sample. Use 2-point calibration when you know the sample is acidic (low pH) or basic (high pH). For acidic samples, use standard buffers of pH 7.00 and pH 4.01. For basic samples, use standards of pH 7.00 and pH 10.01. Use a 3 (or more) point calibration when the sample pH is completely unknown.

Contact your OAKTON® distributor for information on pH buffer and calibration solutions.

Standard pH Buffers

The following table shows the various pH values at different temperature of the solution during calibration. The table also illustrates why a calibration value may be different from the buffer value at 25°C.

Temperature		pH buffer values		
°C	°F	4.01 (phthalate)	7.00 (neutral phosphate)	10.00 (carbonate)
0	32	4.01	7.12	10.33
5	41	4.01	7.09	10.25
10	50	4.00	7.06	10.18
15	59	4.00	7.04	10.11
20	68	4.00	7.02	10.05
25	77	4.01	7.00	10.00
30	86	4.01	6.99	9.95
35	95	4.02	6.98	9.92
40	104	4.03	6.98	9.88
45	113	4.04	6.97	9.85
50	122	4.06	6.97	9.82
55	131	4.07	6.98	9.80
60	140	4.09	6.98	9.77
70	158	4.12	6.99	9.73
80	176	4.16	7.00	9.69
90	194	4.20	7.02	9.66

starting up

calibration

measurement

set up
mode

electrode
care

troubleshooting

specifications

accessories

appendixes

warranty

return of
items

Appendix 4: Meter factory default settings

Resetting the meter to factory default settings clears all calibration data and most other set up functions you might have changed. The following settings will remain as you have set them:

- temperature unit of measure (°C or °F)
- The temperature offset calibration value

NOTE: Conductivity/TDS and pH data are cleared separately from each other.

- To clear pH data, see Sub group P4.0 on page 30
- To clear conductivity/TDS data, see Sub group P9.0 on page 37

Type	Parameter	Default	Remarks
pH parameters			
P1.1	Viewing pH	---	No calibration data for pH 1.68
P1.2	calibration data	---	No calibration data for pH 4.01
P1.3		---	No calibration data for pH 7.00
P1.4		---	No calibration data for pH 10.00
P1.5		---	No calibration data for pH 12.45
P2.1	View electrode offset	0.00 mV	No offset adjustment
P2.2	View electrode slope	100.0%	No slope adjustment
P3.1	Ready indicator	Ready on	Ready indicator on; auto endpoint off
P3.2	# pH cal. points	3	3 pH calibration points available (of a 2-5 point range)
P3.3	NIST or USA buffer sets	USA	—
P3.4	°F or °C	no default	°F or °C remains as selected
P4.0	pH factory default	no	Retains your current settings
Conductivity/TDS parameters			
P5.1	Viewing cond./TDS	---	No calibration data for Range 1 (0.00-19.99 µS / 0.00-9.99 ppm)
P5.2	calibration data	---	No calibration data for Range 2 (0.0-199.9 µS / 10.0-99.9 ppm)
P5.3		---	No calibration data for Range 3 (0-1999 µS / 100-999 ppm)
P5.4		---	No calibration data for Range 4 (0.00-19.99 mS / 1.00-9.99 ppt)
P5.5		---	No calibration data for Range 5 (0.0-199.9 mS / 10.0-199.9 ppt)
P6.1	Viewing cond./TDS	1.000	No offset for effective cell constant (0.00-19.99 µS / 0.00-9.99 ppm)
P6.2	effective cell constant	1.000	No offset for effective cell constant (0.0-199.9 µS / 10.0-99.9 ppm)
P6.3		1.000	No offset for effective cell constant (0-1999 µS / 100-999 ppm)
P6.4		1.000	No offset for effective cell constant (0.00-19.99 mS / 1.00-9.99 ppt)
P6.5		1.000	No offset for effective cell constant (0.0-199.9 mS / 10.0-199.9 ppt)
P7.1	Ready indicator	Ready on	Ready indicator on; auto endpoint off
P7.2	°F or °C	no default	°F or °C remains as selected
P7.3	ATC on or off	ATC on	—
P7.4	Set Cond-to-TDS factor	0.5	Adjustable from 0.4 to 1.0
P8.1	Temp. coefficient	2.1% per °C	Adjustable from 0 to 10% per °C
P8.2	Normalization temp	25°C	Adjustable from 15 to 30°C / 59 to 86°F
P9.0	cond./TDS factory default	no	Retains your current settings

starting up

calibration

measurement

set up
mode

electrode
care

troubleshooting

specifications

accessories

appendixes

warranty

return of
items

starting up

calibration

measurement

set up
mode

electrode
care

troubleshooting

specifications

accessories

appendixes

warranty

return of
items

Warranty

OAKTON warrants this meter to be free from significant deviations in material and workmanship for a period of three years from date of purchase. OAKTON warrants the probes to be free from significant deviations in material and workmanship for a period of six months from date of purchase. If repair or adjustment is necessary and has not been the result of abuse or misuse within the warranted time period, please return—freight prepaid—and correction will be made without charge. OAKTON alone will determine if the product problem is due to deviations or customer misuse.

Return of items

Authorization must be obtained from our Customer Service Department before returning items for any reason. When applying for authorization, please include data regarding the reason the items are to be returned. For your protection, items must be carefully packed to prevent damage in shipment and insured against possible damage or loss. We will not be responsible for damage resulting from careless or insufficient packing. a restocking charge will be made on all unauthorized returns.

NOTE: We reserve the right to make improvements in design, construction, and appearance of products without notice