

INSTRUCTION MANUAL

Thermocouple Thermometer

Type J, K, T



Thermo
SCIENTIFIC

ISO 9001
SUPPLIER CERTIFIED

OAKTON[®]

Part of Thermo Fisher Scientific

68X450501 Rev 0 02/08



TABLE OF CONTENTS

1.	INTRODUCTION	1
2.	SAFETY PRECAUTIONS	2
3.	SPECIFICATIONS	3
4.	BATTERY INSTALLATION AND REPLACEMENT	5
5.	INSERTING AND REMOVING OPTIONAL RUBBER ARMOUR	6
6.	ASSEMBLING OPTIONAL HANDSFREE ACCESORIES	7
7.	SELF TEST	8
8.	CONNECTING A THERMOCOUPLE ...	8
9.	KEY FUNCTIONS	10
10.	Display Overview	11
11.	SELECTING TEMPERATURE SCALE	12
12.	HOLD FUNCTON	12
13.	MIN AND MAX FUNCTION	13
14.	AUTO OFF FUNCTION	13
15.	CALIBRATION	13
16.	CANCELING A FIELD CALIBRATION	14
17.	FIELD CALIBRATION LOCKOUT AND RE-ENABLE	15
18.	MAINTENANCE	16
19.	CLEANING	16
20.	BATTERIES	16
21.	TROUBLE SHOOTING	17
22.	ACCESSORIES	18
23.	WARRANTY	19
24.	PRODUCT RETURN	19
25.	INNOCAL® CALIBRATION AND REPAIR SERVICES (NORTH AMERICA)	20

1. INTRODUCTION



This versatile hand-held instrument provides highly accurate temperature measurements. The instrument is designed for easy operation and includes the following features:

- Operator selection of Celsius or Fahrenheit scale
- Resolution of 0.1° C/F from -199.9 to 999.9°
- Large backlit LCD with two lines of four-digit display
- Hold feature for temporarily retaining a reading
- Displays min and max readings
- Field calibration capability
- Disabling of Auto-Off function
- Low battery warning
- Two blade female ANSI mini-connector input
- Operates with a wide selection of probes

2. SAFETY PRECAUTIONS

WARNING:

1. This instrument is designed to accept low level signals supplied by standard thermocouples. Under NO circumstances should the input voltage exceed the specified 50V RMS.
2. To prevent ignition of a hazardous atmosphere, batteries must only be changed in an area known to be non-hazardous.

CAUTION:

1. Do not use or store this instrument in microwave ovens or any abnormally hot or cold areas.
2. Weak batteries should not be left in the instrument. Dead batteries can leak and cause damage to unit.

DANGER:

1. Voltages present at the thermocouple may also be present at the battery terminals. Always disconnect the Thermocouple when changing batteries.

3. SPECIFICATIONS

Thermocouple Thermometers

<u>Type</u>	<u>Temperature range</u>
Temp10J (Type J)	-210°C to 1200°C (-346°F to 2192°F)
Temp10K (Type K)	-250°C to 1372°C (-418°F to 2501°F)
Temp10T (Type T)	-250°C to 400°C (-418°F to 752°F)

Out of range display: - - - -

Resolution

0.1°/1° auto-ranging,
0.1° C/F from -199.9 to 999.9°,
1° C/F outside this range

Accuracy

Below -150 °C (-238 °F):
±0.25% of reading ±1 °C (±2 °F)

Above -150 °C (-238 °F):
±0.1% of reading ±0.4 °C (±0.7 °F)

Display

Backlit LCD of viewing area 58 X 40mm

Min/Max Function

Yes

Auto Off (after 17.5 minutes)

Enable/Disable option available

Stability Criteria

Yes, upon stability of 5 seconds

Display update rate

0.5 sec per update.

Input

One thermocouple with ANSI connector.

Input Protection

50V rms

Storage

-40°C to 65°C (-40°F to 149°F)

Humidity

10% to 90% (non-condensing)

Battery Life

Size: Three AA, 1.5V; Alkaline

Life: 750 hours continuous, typical,
(without backlighting)

Dimensions**Without Armor:**

175mm (L) X 97mm (W) X 42mm (H)

With Armor:

180mm (L) X 102mm (W) X 52mm (H)

Weight with batteries

Without Armor: 267g

With Armor: 362g

Ingress protection:

Meets IEC-529 IP-54 for dust and water resistant enclosures (probe attached)

CE Compliance

EN61326-1/A1: 1998 (EU EMC Directive)

4. BATTERY INSTALLATION AND REPLACEMENT

The total battery life without backlighting is about 750 hours. Each bar of the battery annunciator represents 200 hours. A blinking empty battery annunciator indicates 150 hours remaining.

Selected settings are stored in memory and will remain in memory even after power is turned off, or while batteries are being replaced.

1. Before changing battery, turn instrument off and disconnect thermocouple.
2. Loosen screw and lift battery cover off back of case.
3. Remove the three AA batteries.
4. Insert three new batteries observing polarity.
5. Install cover and tighten screw.

5. INSERTING AND REMOVING OPTIONAL RUBBER ARMOUR

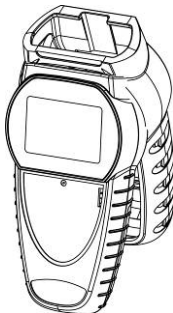

1. To insert thermometer into the optional rubber armor, slide in from the top of meter before pushing the bottom edges of meter down to set it into position. Lift up the stand at the back of meter for bench top applications if necessary.
2. To remove thermometer from armor, push out from the bottom edges of meter until it is completely out of boot.

6. ASSEMBLING OPTIONAL HANDSFREE ACCESSORIES

You can use the optional magnets and strap in the Hands Free Kit accessories for hands-free operations.

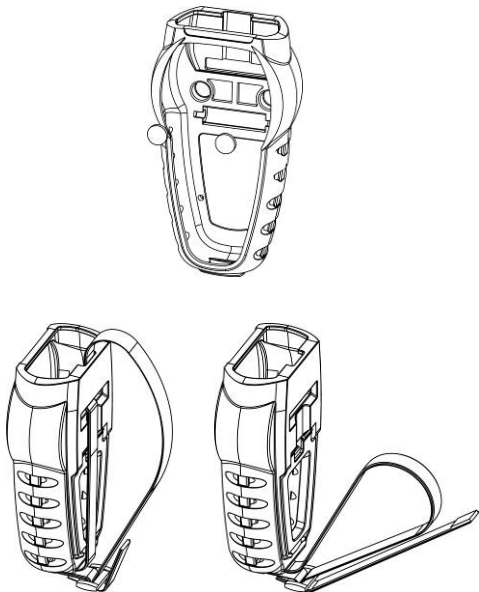

7. SELF TEST

Press the **on/off** key. The thermometer performs a self-test and all display digits and indicators, should remain on for approximately one second. The thermometer will then display the thermocouple thermometer type and resume to the measurement mode.

8. CONNECTING A THERMOCOUPLE

Use the correct thermocouple type for your instrument. Using an incorrect thermocouple type will result in erroneous readings. Thermocouples are color coded by type using the North American ANSI Color Code as follows:

<u>TYPE</u>	<u>COLOR</u>
J	Black
K	Yellow
T	Blue

Thermocouple connectors have one wide blade and one narrow blade. Do not force connector in backwards. Connect thermocouple to receptacle at top of instrument as shown in the following illustration.

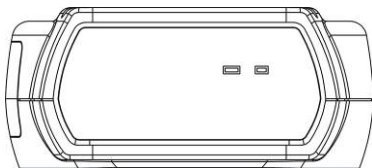



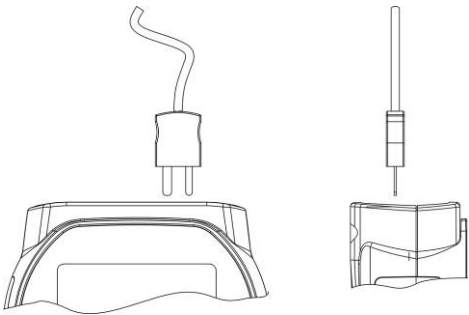

Thermocouple wiring polarity must be correct. If readings decrease as the temperature increases, the thermocouple wires may be reversed. The red wire is negative for thermocouple wires manufactured in North America.

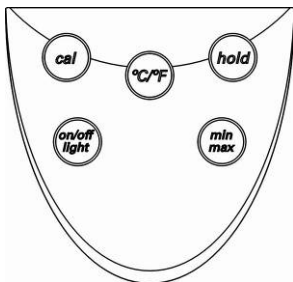

9. KEY FUNCTIONS



	Toggle between Celsius or Fahrenheit.
	Activates Calibration mode for 0°C offset calibration (after field calibration enabled).
	Activates/Deactivates freezing of the measured reading while in measurement mode.
	Activates/Deactivates display of the minimum and maximum readings.
	Powers on and shuts off the thermometer by holding it for 3 seconds. Otherwise, it activates/deactivates the backlight display. (Backlight will automatically turn off within 30 seconds of activation).

10. Display Overview

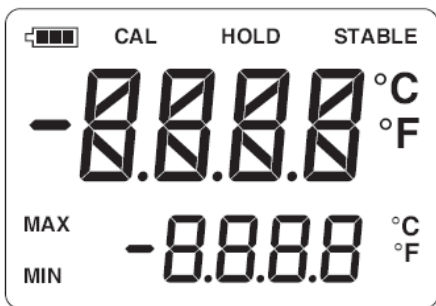

°C/°F	Celsius or Fahrenheit indicator.
MIN	Minimum reading annunciator.
MAX	Maximum reading annunciator.
	3 Bar : < 750 hours 2 Bar : < 550 hours 1 Bar : < 350 hours Blinking: < 150 hours
CAL	Blinks during calibration mode. Remains in display indicating field calibration is active.
HOLD	Remain in display during hold mode.
STABLE	Displayed upon recognizing final value
Err CAL	Error indicator on main digit display Indicates calibration error due to out of tolerance value.

If a thermocouple is not connected or if the thermocouple is defective, the display will indicate "OPEn".

Thermocouples are sensitive at the tip or measuring junction. When taking measurements, allow time for the reading to stabilize. Multiplying the time constant of the probe by 5 will give you the approximate time required.

11. SELECTING TEMPERATURE SCALE

Select °C or °F by pressing the **°C/°F** key. Each time the key is pressed the temperature scale will switch. Switching between °C and °F can be done at any time during operation.

Each time you turn the instrument on, it will power up with the same settings that were set when the unit was last turned off.

12. HOLD FUNCTION

Press the **hold** key to retain the reading on the display. Press the **hold** key again for normal operation.

13. MIN AND MAX FUNCTION

Press the **min/max** key to toggle between the minimum and maximum readings. The minimum and maximum reading function is ideal for monitoring unattended operations while continually displaying every temperature change that occurs. The minimum and maximum values are sensed and automatically stored.

To exit and clear this function, press the **min/max** key for 3 seconds.

14. AUTO OFF FUNCTION

The thermometer has a default auto off function of 17.5 minutes.

To deactivate this function, press and hold the **min/max** key while turning on the meter using the **on/off** key. "A.OFF nO" will appear indicating that the auto off function is disabled.

15. CALIBRATION

The thermometer is factory calibrated and does not require calibration before use. The Calibration function allows single point calibration of the thermometer, at 0°C (32°F) to compensate for thermocouple off-set error. It is NOT necessary to perform a field calibration to obtain specified meter accuracy. Use the field calibration feature to improve thermometer/probe accuracy or to

compensate for thermocouple drift.

1. Pack sensing end of probe in a container tightly packed with crushed ice and filled with distilled water. Allow temperature to stabilize.
2. Press and hold the **cal** key for 3 seconds to enter the calibration mode, the CAL annunciator on the display starts blinking. Release the **cal** key.
3. If the measured temperature is from - 10°C to 10°C (14 to 50°F), when the temperature reading is stable, press the **cal** key.

The CAL indicator will stop blinking and the reading will be set to 0°C (32°F). The CAL indicator will remain turned on, indicating a field calibration is active.

If “Err CAL” is displayed, either the displayed reading is outside the above limits or the batteries are weak.

16. CANCELING A FIELD CALIBRATION

1. Turn the thermometer off.
2. Hold the **cal** key down while pressing the **on/off** key.

The field calibration is cancelled and the thermometer reverts to the default factory calibration. The CAL annunciator is now turned off.

17. FIELD CALIBRATION LOCKOUT AND RE-ENABLE

The calibration lockout feature prevents any field calibration changes. The lockout remains in effect until a lockout re-enable has been performed. Use the following procedures to lockout or re-enable the field calibration operation.

LOCKOUT PROCEDURE

1. Turn the thermometer off.
2. Simultaneously press and hold the **cal** and the °C/°F keys down and momentarily press the **on/off** key. Continue to hold the **cal** and °C/°F keys until the measurement mode is displayed.

RE-ENABLE PROCEDURE

1. Turn the thermometer off.
2. Simultaneously press and hold the **hold** and the **cal** keys down and momentarily press the **on/off** key. Continue to press the **hold** and **cal** keys until the measurement mode is displayed.

18. MAINTENANCE

Properly used, the thermometer should maintain calibration indefinitely and not require service other than occasional cleaning of the housing and changing of the batteries.

19. CLEANING

WARNING:

TO PREVENT IGNITION OF A HAZARDOUS ATMOSPHERE BY ELECTROSTATIC DISCHARGE, CLEAN WITH DAMP CLOTH.

Do not clean with abrasives or solvents. Use mild detergents, never immerse nor use excessive fluid.

20. BATTERIES

If there is no display when the thermometer is turned on, check condition of the three AA batteries. Also check that the battery terminals are clean and batteries are properly installed. If replacement is necessary, refer to the BATTERY INSTALLATION AND REPLACEMENT section for replacement procedure.

21. TROUBLE SHOOTING

The following chart lists the most probable faults. There are no internal adjustments or user-replaceable parts.

FAULT	ACTION
NO Display	Check condition of batteries. Check that batteries are inserted properly.
Display shows - - - -	Out of range indication.
Display Shows OPEN	No thermocouple connected in the Connector.
Display Shows Err	If display shows this message other than during the field calibration mode, please return the instrument for servicing.

22. ACCESSORIES

Replacement Meter and Meter Accessories

Item	Oakton	Thermo Scientific
Type J thermometer	35427-00	TSTEMP10J
Type K thermometer	35427-10	TSTEMP10K
Type T thermometer	35427-20	TSTEMP10T
Rubber Armour with Stand	35427-80	ARMORTEMP
Hands Free Kit (Two Magnets and a Strap)	35427-85	HNDSFRKIT
General purpose probe (immersion Into liquids), type J	08517-55	EC-TPGLPJ-01M
Penetration probe (meat, semi-soft Materials), type J	08517-65	EC-TPPENJ-01M
Surface probe (direct contact on Hot surfaces), type J	08517-60	EC-TPSURJ-01M
Clip-on probe (surface contacts- Electronics), type J	08469-00	EC-TPCLPJ-01M
General purpose probe (immersion Into liquids), type K	08516-55	EC-TPGLPK-01M
Penetration probe (meat, semi-soft Materials), type K	08516-65	EC-TPPENK-01M
Surface probe (direct contact on Hot surfaces), type K	08516-60	EC-TPSURK-01M
Clip-on probe (surface contacts- Electronics), type K	08469-02	EC-TPCLPK-01M

23. WARRANTY

The Manufacturer warrants this product to be free from significant deviations from published specifications for a period of **three** years. If repair or adjustment is necessary within the warranty period, the problem will be corrected at no charge if it is not due to misuse or abuse on your part as determined by the Manufacturer. Repair costs outside the warranty period, or those resulting from product misuse or abuse, may be invoiced to you.

24. PRODUCT RETURN

To limit charges and delays, contact the seller or Manufacturer for authorization and shipping instructions before returning the product, either within or outside of the warranty period. When returning the product, please state the reason for the return. For your protection, pack the carefully and insure it against possible damage or loss. The Manufacturer will not be responsible for damage resulting from careless or insufficient packing.

25. INNOCAL® CALIBRATION AND REPAIR SERVICES (NORTH AMERICA)

Optimum performance of your temperature-measuring instrument is not a timeless condition. To ensure quality measurements, have your instrument calibrated regularly. Trust InnoCal® to satisfy your calibration and equipment repair needs. With over a decade of service, we've helped thousands of customers meet ISO, FDA, EPA, GLPs/cGMPs and other quality standards.

Conformity*

ISO/IEC 17025:2005 accredited
NIST Handbook 150, 2000 Edition
ANSI/NCSL Z540-2-1997
NIST Technical Note 1297
ISO 9000:2000

Fast Service

Our substantial inventory of replacement parts ensures a fast turnaround and prevents costly downtime. Most instruments serviced in five business days!

Excellent Value

Get quality at a fair price. Our InnoCal NIST-traceable certificates offer extensive test data on a broad range of measurement parameters without breaking the bank!

Reliable Support

Trust in our free diagnostic support and troubleshooting advice. Our factory-trained metrologists and technicians are armed with years of experience and extensive technical data.

Convenient Reminders

It's so easy to keep your instruments functioning properly. Based on your requirements, InnoCal will send you a reminder when it's time to re-certify or service your instrument.

We provide you with the documentation you need to meet your most stringent quality requirements for the control of inspection, measuring, and test equipment.

Certification includes certificate of calibration with test data, including:

- description and identification of the item certified
- condition of the item
- issue date
- identification of calibration procedure
- calibration date
- as found/as left test data (where applicable)
- signature of technician
- statement of estimated uncertainty
- list of equipment used to perform calibration (including their calibration dates)

With today's high quality standards such as ISO 9000, certification is becoming increasingly important. Traceability is not a timeless condition. It must be verified and maintained over the life of the calibration to ensure the highest accuracy possible. When you have your calibration done by InnoCal, we will send you an automatic reminder when it is time to recalibrate your instrument.

Are your calibration certificates good enough?

InnoCal surpasses the competition by providing the most complete certificates as required by NIST. All of our certificates include measured data and point-by-point measurement uncertainty, and by request, we'll provide test accuracy and test uncertainty ratios at no extra cost. Call us today and see why InnoCal is The Choice of Quality.

*See our Scope of Accreditation for any limitations.

Calibration test points against NIST-traceable standards	Meter only	Probe only	System (meter + probe)*
<p>Four test points across range of instrument.</p> <p>Meters: -270 to 2316°C (-454 to 4200°F);</p> <p>Probes & Systems: -80 to 1000°C (-112 to 1832°F). Actual range is dependent on type of probe</p>	MM-17000-10	MM-17001-10	MM-17002-10

InnoCal—The Choice of Quality
866-InnoCal (866-466-6225)
InnoCalSolutions.com

For calibration services outside of North America, please contact your Local Distributors or Local Certification Body.

TECHNICAL ASSISTANCE

If you have any questions about the use of this product, contact the Manufacturer or authorized seller.

For more information on OAKTON Instruments/Thermo Scientific Products, please contact your nearest distributor or visit our web site listed below:

OAKTON Instruments

P.O. Box 5136

Vernon Hills, IL 60061, USA

Tel (in U.S.): 888-462-5866

Tel (outside U.S.) 1-847-549-7600

Fax: (1) 847-247-2984

Website: www.4oakton.com

E-mail: info@oakton.com

Thermo Scientific

Water Analysis

Environmental Instruments

Blk 55 Ayer Rajah Crescent

#04-16 Singapore 139949

Tel: (65) 6778 6876

Fax: (65) 6773 0836

Website: www.thermo.com

Email: eutech@thermofisher.com

Distributed by: