



Product Manual

*The Safety Team's
Resource for Setup,
Installation, and Operation*

Edition: 2

July 1, 2020

Part number: 17159042-1

INDUSTRIAL

SCIENTIFIC

Industrial Scientific Corporation, Pittsburgh, PA USA

Industrial Scientific Co., Ltd. Shanghai, China

©2020 Industrial Scientific Corporation

All rights reserved. Published 2020.

Revision 2

www.indsci.com/tgxgateway

Contents

Chapter 1.....	1
General Information.....	1
Terms of Use.....	1
Warnings and Cautionary Statements.....	1
Compliance.....	3
Cellular and Satellite Connectivity.....	3
Chapter 2.....	5
Product Information.....	5
Connected Safety.....	5
Key Features.....	6
Location restriction.....	6
Instrument compatibility.....	6
Communications.....	6
TGX operation and vehicle power.....	7
Antenna and Power Cable Requirements.....	7
Vehicle Requirements.....	8
TGX Specifications.....	8
Care.....	9
Chapter 3.....	11
Setup.....	11
Overview.....	11
Unpacking.....	11
Activation.....	12
Preinstallation Settings.....	12
TGX Gateway settings in iNet Control.....	12
Instrument settings.....	13
Chapter 4.....	15
Installation.....	15
General Information.....	15
Hardware Overview.....	15
Installation-site Precheck.....	18
Tasks completed.....	18

Equipment required.....	18
Installation site requirements	18
TGX Mounting	19
Cable Installation.....	19
Setup	19
Connections.....	21
Chapter 5.....	25
System Validation	25
Overview	25
Power On	25
LED Check.....	27
Antenna or module error guidelines	31
Wireless Validation.....	32
Chapter 6.....	35
Operation, Service, and Warranty	35
Operation	35
Settings.....	35
Settings apps	36
Wireless Connections.....	38
LENS Wireless.....	38
Cellular, GPS, and Satellite.....	39
Service	39
Power Off	39
Warranty.....	40
Limitation of liability.....	40
Contact Information	41

Tables and Figures

Table 1.1 Warnings and cautionary statements.....	1
Table 1.2 Compliance.....	3
Figure 2.1 Industrial Scientific connected safety.....	5
Table 2.1 TGX Gateway compatible gas-detection instruments	6
Table 2.2 Required TGX cables.....	7
Table 2.3 TGX Gateway specifications.....	8
Table 3.1 Package contents	11
Figure 3.1 Required activation values and where to find them	12
Figure 3.2 Preinstallation settings using iNet Control	12
Table 3.2 Equipment settings required for iNet Now live monitoring.....	14
Table 4.1 Antennas, adhesive pad, and power cables	16
Figure 4.1 TGX hardware overview	17
Figure 4.2 Sample antenna placement.....	20
Table 4.2 Power cable wires-to-vehicle connections and voltage requirements	22
Figure 4.3 Cables-to-TGX connections.....	23
Figure 5.1 LED identifiers	26
Table 5.1 Identifying possible power connection issues	26
Table 5.2 LED indicators and what they mean	28
Table 5.3 Identifying antenna or module error issues	31
Figure 5.2 Wireless validation process	32
Table 6.1 Setting applications.....	36
Figure 6.1 Vehicle-related settings using TGX Configuration Manager (TCM)	37
Table 6.2 Range guidelines to maintain LENS Wireless connections.....	38

General Information

Terms of Use

Warnings and Cautionary Statements

Compliance

Cellular and Satellite Connectivity

Terms of Use

Due to the nature of wireless communications, transmission and reception of data is not guaranteed. Data may be delayed, corrupted (i.e., have errors), or totally lost. Although significant delays or losses of data are rare when wireless devices such as the TGX™ Gateway are used in a normal manner with a well-constructed communication network, the user should not rely on the TGX Gateway during situations where failure to transmit or receive data could result in damage of any kind to the user or any other party, including but not limited to personal injury, death, or loss of property. Industrial Scientific accepts no responsibility for damages of any kind resulting from delays or errors in data transmitted or received using the TGX Gateway or for failure of the TGX Gateway to transmit or receive such data.

Warnings and Cautionary Statements

Table 1.1 Warnings and cautionary statements





-  Read and understand this Product Manual completely before installing or operating the TGX Gateway.
 -  If you believe the TGX is not operating correctly, remove it from service and contact Industrial Scientific.
 -  Do not operate the TGX in areas where blasting is in progress or where explosive atmospheres may be present.
 -  Do not operate in classified hazardous areas, near medical equipment, near life support equipment, or near any equipment susceptible to radio interference. The TGX transmits signals that could interfere with this equipment.
 -  For compliance with the Federal Communications Commission (FCC), only a trained and qualified installer must complete the installation.
-

Table 1.1 Warnings and cautionary statements

- ⚠ Install, operate, and service this equipment in accordance with your company's safety policy and any local Occupational Health and Safety Standards.
 - ⚠ The TGX Gateway is equipped with various radios that transmit signals. When the power cable is connected, the TGX may transmit signals. *Before* connecting the power cable, be sure each antenna is connected to its respective SMA input on the back of the TGX. Powering the TGX without these antennas connected could result in damage to the internal transmitting devices, causing reduced range, communication failures, or both.
 - ⚠ The antenna cables carry high frequency signals; handle, install, and operate to prevent injury and damage to the cable.
 - ⚠ For compliance with FCC radio-frequency exposure limits, ensure a minimum distance of 20 cm (7.87 ") from each antenna to all persons.
 - ⚠ Ensure a minimum distance of 61 cm (24 ") between the antennas to help prevent Radio Frequency Interference (RFI) during transmission.
 - ⚠ The TGX Gateway antenna modules and their neodymium magnets can cause injury. To avoid injury, Industrial Scientific recommends the following.
 - Persons with a pacemaker or implantable cardio defibrillator (ICD) should maintain a minimum separation distance of 90 cm (36 ") between the pacemaker or ICD and the magnet. Consult your physician or pacemaker or ICD manufacturer for additional guidance and recommendations.
 - Neodymium magnets have a strong attractive force. Each can attract quickly when in close proximity to another magnet or a metal surface, and cause injury. The magnet material is brittle; it can crack or splinter on impact to cause injury and potentially become a flying hazard. Use protective gloves and eyewear to avoid a potentially severe pinch injury, cut, or splinter.
 - Keep magnets away from electronic devices, identification cards, credit cards, and other items that use microchips, magnets, or magnetic fields.
 - ⚠ Connect only compatible antennas specified by Industrial Scientific.
 - ⚠ **WARNING:** Substitution of components may cause an unsafe condition.
 - ⚠ The TGX exterior case, internal components, and antennas from Industrial Scientific are *not* customer serviceable.
 - Do not open the TGX or its antenna enclosures or alter them in any way.
 - Do not use extensions with the antenna cables.
 - Do not alter the power cable in any way other than to trim the unterminated ends of its wires; do so only when the power cable input and its wires are *not* connected.
 - ⚠ Do not use the TGX service input, which is for Industrial Scientific use only.
-

Table 1.1 Warnings and cautionary statements

⚠	The antenna and power cables must be routed such that they will not be kinked, crushed, or subjected to repeated bending (e.g., by a vehicle door).
⚠	Ensure each antenna cable is connected to its <i>one-and-only</i> dedicated input. The cables are <i>not</i> interchangeable.
⚠	The TGX requires fused connections to the vehicle battery and the ignition system; <i>direct connections are not supported</i> .
⚠	Ensure each power-cable wire is connected to its <i>one-and-only</i> intended termination point and ensure each connection's integrity to avoid fire, damage to the vehicle's ignition system, or another unsafe condition or undesired result.
⚠	Do not interact with the TGX while driving. In many states and provinces, interacting with such communications devices while in control of a vehicle constitutes distracted driving and is a punishable offense.

Compliance

The TGX™ Gateway meets the standards and approvals listed below.

Table 1.2 Compliance

Certifying body	Designation
PTCRB	Certified for GSM: 850/900/1800/1900, UMTS FDD: Band I/Band II/Band V/Band VIII
FCC	Federal Communications Commission (FCC) IDs: Q639603-SB, QR4WF5370M08, S4GEM35XB, QIPEHS8, and U9O-SM220 This device complies with Part 15 of the FCC Rules. Operation is subject to the following two conditions: (1) this device may not cause harmful interference, and (2) this device must accept any interference received, including interference that may cause undesired operation
Industry Canada	CAN ICES-3 (B)/NMB-3(B) of ICES-003

Cellular and Satellite Connectivity

The TGX Gateway requires a satellite and/or cellular signal to transmit data. Industrial Scientific will provide a cellular and satellite data plan for the life of the Gateway (the “Plan”). The Plan will be effective after the customer activates/registers the product, as discussed in Section 3 of this manual. The Plan will remain effective for as long as the Buyer: (i) continues to pay the monthly service fee (as described during the activation process or other relevant documentation (e.g. iNet agreement)); and (ii) uses the Plan only for purposes described in this manual and in approved geographic regions (both as described during the activation process or other relevant documentation (e.g. iNet agreement)). Industrial Scientific reserves the right to terminate the Plan, at its sole discretion, if Buyer fails to comply with the foregoing requirements

Product Information

Connected Safety

Key Features

Antenna and Power Cable Requirements

Vehicle Requirements

TGX Specifications

Care

Connected Safety

The TGX™ Gateway enables communication between Industrial Scientific gas-detection instruments and *iNet® Control* software. Equipped with LENS™ (Linked Equipment Network for Safety), cellular, and satellite capabilities, TGX provides the wireless connections needed for the transmission of gas readings, alarms, GPS coordinates, and other data to *iNet Control*. This supports cloud-based *iNet Now* live monitoring, allowing remote visibility to in-field conditions and potentially hazardous events. Connected safety from Industrial Scientific is depicted below and supports the following:

- The safety team's preparedness for hazardous and unforeseen events.
- Cooperation among first responders within your company and from local authorities.

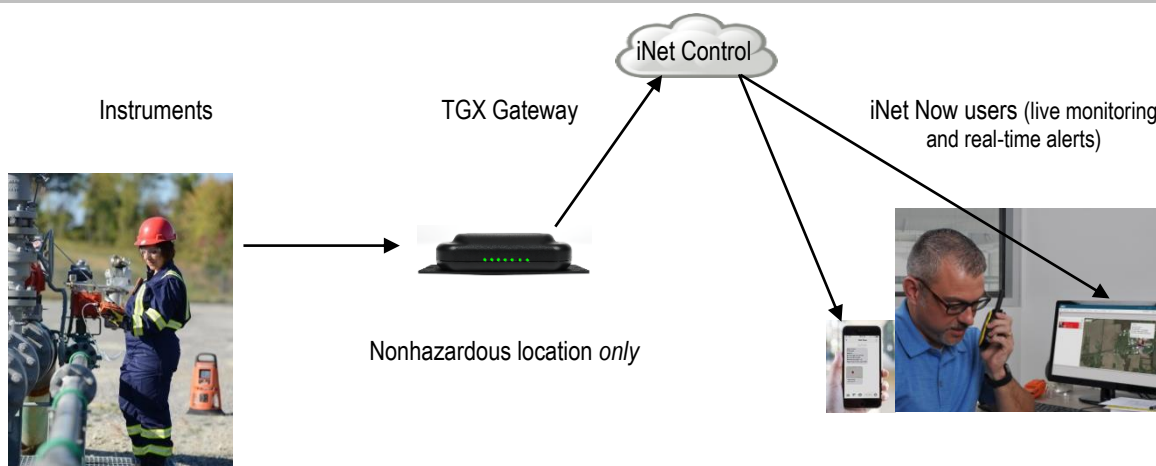

Figure 2.1 Industrial Scientific connected safety

Key Features

The TGX is designed for the “mobile worker”, someone who may travel to one or more sites, including locations outside a company’s in-fence facilities. This in-vehicle mounted gateway with its rooftop antennas permits remote, live monitoring of its in-range, LENS connected gas-detection instruments.

Location restriction

IMPORTANT: Operate the TGX Gateway *only in nonhazardous locations*. LENS wireless permits the wireless connection of a gas-detection instrument that is in a hazardous location to reach the TGX in its nonhazardous, in-range location.

Instrument compatibility

Use the information supplied below to ensure gas-detection instruments are compatible with the TGX Gateway. As needed, upgrade instrument firmware to the required version, add LENS Wireless functionality, and refer to the instrument's product manual.

Table 2.1 TGX Gateway compatible gas-detection instruments

Instrument	Required firmware version	LENS Wireless required	Industrial Scientific <i>Product Manual</i> part number
Ventis® Pro Series	V3.0 or higher	Yes	17156830
Radius® BZ1 Area Monitor	V3.0 or higher	Yes	17155915

Communications

TGX Gateway uses LENS Wireless to communicate with gas-detection instruments. It uses cellular and satellite (if equipped) to transmit those communications to iNet® Control for iNet Now live-monitoring. Wireless communications are further described below.

Instrument–TGX Gateway

LENS Wireless enables communication among wirelessly connected instruments and gateway units operating within a LENS group (e.g., Group A). The following also apply.

- Ten named LENS groups (A – J) are available.
- Each LENS group can host up to 25 equipment items.
- More than one gateway can be included in a LENS group.

Instrument communications exchanged through LENS are automatically encrypted with the Industrial Scientific key. Optionally, a customer-supplied encryption key can instead be used.

TGX Gateway–iNet Control

TGX Gateway transmits communications it receives from gas-detection instruments to iNet Control using cellular or satellite (if equipped). A Cellular and Satellite Unit will first use cellular and if that is not available, satellite.

During operation, when the cellular or satellite network connection is lost or cannot be established and messages cannot be sent to iNet, TGX will temporarily store the instrument data it receives and will retry

transmission upon network connection. Stored data are purged after transmission to iNet Control or when the data have aged more than 12 hours, whichever comes first; data are purged every 30 minutes.

TGX Gateway cellular communications are secured through HTTPS. Satellite communications are byte encoded.

TGX operation and vehicle power

To allow TGX operation to continue after the vehicle ignition is turned off and to maintain the desired minimum battery voltage for the vehicle, use the features described below. These customer-settable options are accessed through an internet connection to the TGX Configuration Manager (TCM), which is discussed in [Settings](#).

Keep awake

Enable the *keep-awake* feature to permit the TGX to continue operation after the vehicle is turned off. Set the amount of time the unit will operate (keep awake) between engine shutdown and TGX power off. The *critical low voltage* feature, discussed below, overrides the keep-awake feature.

Critical low voltage

Use the *critical low voltage* feature and your knowledge of the vehicle's power system to set the battery voltage at which the TGX will power itself off. Battery voltage requirements vary by vehicle and can be affected by operating conditions, battery condition, and other factors. The critical low voltage value should reflect the customer-determined minimum voltage that will achieve the following:

- Prohibit a running engine from the full loss of its battery power.
- Prohibit a nonrunning engine from completing an ignition cycle.

Notes:

10 VDC is the minimum voltage required for TGX start-up.

If the vehicle's battery becomes depleted below the *critical low voltage* threshold, to restore power to the TGX, you may need to disconnect, then reconnect the power cable to the unit.

Antenna and Power Cable Requirements

TGX wireless communications require the installation of compatible external antennas only from Industrial Scientific. As indicated below, both the *TGX Primary Antenna* and *TGX Satellite Antenna* are required.

Table 2.2 Required TGX cables

Item (part number)	Description
TGX Primary Antenna (17159196)	Supports LENS Wireless functionality, GPS signal reception, and cellular transmission.
TGX Satellite Antenna (17159693)	Supports satellite transmission.
TGX Gateway Power Cable (17159072)	Locking six-pin Molex plug with three wires (battery and ignition wires require fused connections)

Vehicle Requirements

To determine if a vehicle is compatible, note the TGX Gateway power input requirements in the specification table (below). The power-cable wires are connected to the vehicle as discussed in the section, “Connections”.

TGX operation requires placement of a unit’s antennas on the vehicle rooftop. The magnet-mount antennas support connection to a metal rooftop. For any nonmetallic rooftop surface, consult with the installer for options that will provide a solid, rigid connection comparable to the pull force of the antenna’s magnet (see Specifications below).

TGX Specifications

Table 2.3 TGX Gateway specifications

Item	Description
<i>General</i>	
Case materials	Molded, flame-retardant ABS plastic.
Power input	10–30VDC, 300mA@12VDC; <i>only</i> use fused connections (5A fuse is recommended for the red [battery] wire, 1A for the white [ignition] wire).
Indicator lights	Six LEDs; one each for cellular, GPS, satellite, wi-fi, LENS, and power.
Dimensions	10.2 x 10.2 x 7.6 cm (4 x 4 x 3 ").
Weight	284 g (10 oz.)
Operating temperature range	-40 °C to +80 °C (-40 °F to +176 °F).
Storage temperature range	-40 °C to +80 °C (-40 °F to +176 °F).
Operating humidity range	5–95% noncondensing.
Wi-fi	IEE 802.11 b/g/n.
<i>Inputs</i>	
Power	6-pin Molex connector.
SMA	Five external female connectors: one each is used for cellular, GPS, LENS, and satellite; the iNet connector is not used.
Cellular (3G)	Pentaband 800/850/900/1900/2100 MHz.
Cellular (2G Fallback)	Quad band 850/900/1800/1900 MHz.
Satellite	Iridium, frequency: 1616-1626 MHz.
LENS	2.4 GHz ISM band, 250 kbit/s.
GPS	GNSS–NMEA protocol.
Zigbee	Connector not used.
Ethernet (use only for connection to TCM)	RJ45–Cat5 (8P8C Modular) 10/100.

Table 2.3 TGX Gateway specifications

Item	Description
USB (not used)	High Speed 2.0.
<i>Processor and Memory</i>	
CPU	ARM926EJ NXP iMX28 running at 454 MHz.
SDRAM	DDR2 128 Mbyte.
FLASH	256 Mbyte.
<i>Antennas and power cable</i>	
TGX Primary Antenna	LENS, cellular, and GPS antennas; Neodymium magnet 10 kgf (22 lbf.) magnetic pull force.
TGX Satellite Antenna	Satellite antenna; Neodymium magnet 6 kgf (13 lbf.) magnetic pull force.
TGX Power Cable	3-wire power cable with Molex plug.

Care

The unit exterior and antenna-module exteriors can be cleaned with a clean, damp cloth.

Setup

Overview

Unpacking

Activation

Preinstallation settings

Overview

Complete TGX™ Gateway setup before arriving at the installation site. Setup comprises three activities:

1. Unpacking
2. Activation
3. Preinstallation settings

Unpacking

During the unpacking process, account for and examine each ordered item. If any item is missing or appears to have been damaged, contact Industrial Scientific or an authorized distributor of Industrial Scientific products.

Table 3.1 Package contents



Quantity	Item (part number)	Description
1	TGX Gateway (varies)	US (TGX-211), US and Canada (TGX-221) ^a , or Canada (TGX-231).
1	TGX Primary Antenna (17159196)	Required for cellular transmission, GPS reception, and LENS functionality; cable length is 4 m (13.1 ').
1	TGX Satellite Antenna (17159693)	Required for Satellite transmission; cable length is 4 m (13.1 ').
1	TGX Gateway Power Cable (17159072)	3-wire power cable with Molex plug; cable length is 4 m (13.1 ').
2	Adhesive pad for TGX antennas (17159620)	1 for Primary antenna 1 for Satellite antenna; used for mounting antennas on a nonmetallic vehicle roof.

^aCanadian SIM with US roaming capabilities.

Activation

TGX Gateway must be activated using the online Industrial Scientific product activation service at <https://www.indsci.com/product-activation/>. Follow the website's on-screen instructions. Activation will require the unique-to-unit values shown below, which are located on the label affixed to the *unit top*.

Figure 3.1 Required activation values and where to find them

Value	Format
Serial Number (S/N); value format is XXXXXXXX-XXX	
Activation Code (A/C); value format is XXXXXXXX	

Preinstallation Settings

TGX Gateway settings in iNet Control

With activation now complete, and before installation, use iNet® Control to assign values to these LENS-related TGX settings.

- LENS group
- Encryption key

Follow the navigation shown below to reach the unit's *Gateway Summary* page where you can access, review, and edit settings.

Figure 3.2 Preinstallation settings using iNet Control

Log in

If you are unable to log in using your iNet credentials, use the app's provided link to contact Industrial Scientific for assistance.

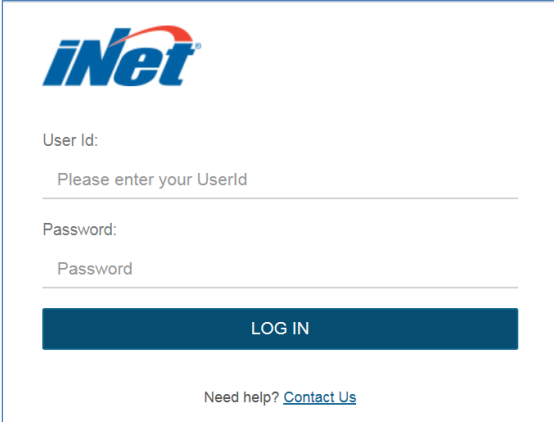

The image shows the iNet Control login interface. At the top is the iNet logo. Below it are two input fields: 'User Id:' with the placeholder text 'Please enter your Userid' and 'Password:' with the placeholder text 'Password'. A blue 'LOG IN' button is positioned below the password field. At the bottom of the form, there is a link that says 'Need help? [Contact Us](#)'.

Account Group/Account

To choose an Account from within the Account Group, click on the list symbol  and choose the desired Account.

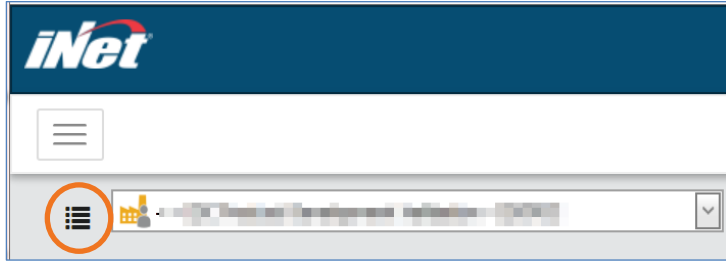

Equipment List

Click on the Equipment drop-down box and choose Equipment List.

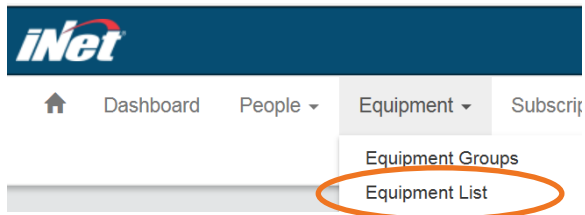

TGX search

Enter the unit's serial number.

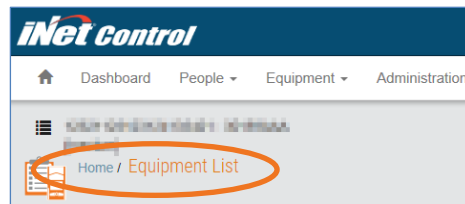

BROWSE EQUIPMENT GROUPS ▶

Drag a column header here to group by that column

Serial Number	Category ↑ ▼	Type ↑ ▼	Equipment Group ▼	Last Upload Time	Firmware Version ▼	User ▼	iNet Now Activated ▼
XXXXXXXX-XXX							

Search results

Find and click on the unit's serial number, which will take you to the unit's summary page.

Serial Number	Category ↑ ▼	Type ↑ ▼	Equipment Group ▼	Last Upload Time	Firmware Version ▼
XXXXXXXX-XXX					
XXXXXXXX-XXX	Gateway	TGX Gateway	TGX VAL	10/9/2019 1:40 PM	3.0.12218

Gateway Summary

Use *Quick Links* to access Settings.

At a minimum review these LENS Wireless settings and edit as needed.

- LENS group
- Encryption key

Optionally edit the GPS interval (for more information, see [Settings](#)).

Account Group : Account

Home / Equipment List / Gateway Summary

General Information	
Serial Number:	XXXXXXXX-XXX
Type:	TGX Gateway
Part Number:	
Manufacturer:	Industrial Scientific Corporation
Setup Date:	8/29/2019
Firmware Version:	3.0.12218
Last Upload Time:	10/9/2019 1:40:54 PM
Language:	



Quick Links
Settings
Edit Gateway Settings

History



- Component History
- Equipment Settings History
- Equipment Alerts History

Instrument settings

To validate TGX wireless functionality later at the installation site, you will need a compatible gas-detection instrument such as a Ventis Pro. It is recommended that a Ventis Pro wireless battery *not* be used; however, if no other battery is available, turn off the battery's wireless feature through instrument settings (Wireless menu).

The table below provides a snapshot of required LENS-related settings and where to locate them on the instrument. As needed, consult the instrument's product manual.

Table 3.2 Equipment settings required for iNet Now live monitoring

Setting item	Equipment item (<i>Product Manual</i> part number)		
	 TGX Gateway (17159042)	 Ventis Pro (17156830)	 Radius BZ1 (17155915)
<i>LENS Wireless settings</i>			
LENS Wireless	No setting required	Menu: Wireless Setting: LENS Wireless <i>Value: iNet Now and Local</i>	Menu: Wireless Setting: Wireless Radio <i>Value: iNet Now and Local</i>
LENS Wireless Group ^a	Menu: LENS Wireless Setting: LENS Group <i>Value: Group X^a</i>	Menu: Wireless Setting: LENS Wireless, LENS Group <i>Value: Group X^a</i>	Menu: Wireless Setting: Group <i>Value: Group X^a</i>
Encryption key ^b	Menu: LENS Wireless Setting: Encryption Key <i>Value^c: Default or custom</i>	Menu: Wireless Setting: LENS Wireless, Encryption <i>Value^c: Automatic or custom</i>	Menu: Wireless Setting: Encryption <i>Value^c: Default or custom</i>

^aIf a named LENS Group (e.g., Group A) is used, all equipment items must be set to the same LENS group or, if available, to scan. "X" is used here to indicate the value for a named group will be a single character in length; available values are letters A through J.

^bAll equipment items must be set to the same encryption key. "Default" or "automatic" sets the unit's LENS Wireless to the Industrial Scientific encryption key, and "custom" to the customer's key. If a custom key will be used, some setup is also required in iNet.

Installation

General Information

Hardware Overview

Installation-site Precheck

TGX Mounting

Cable Installation

General Information

Only qualified personnel should install the TGX™ Gateway.

Except for the placement of its antennas, the TGX Gateway does *not* support a vehicle-exterior or outdoor placement; it *only* supports vehicle-interior mounting.

The TGX Gateway does *not* support use in areas classified as hazardous. Use only in nonhazardous areas.

NOTICE: Only professionally trained automotive personnel should install the TGX, working in a nonhazardous area, using safe practices and equipment. The connection of power and completion of other installation tasks require the customer-installer selection, acquisition, and use of equipment, tools, facilities, and services. All customer-installer supplied equipment, tools, facilities, and services needed to connect or disconnect power and otherwise install (or uninstall) the TGX must comply with and be used in ways that meet any restrictions imposed by local, state, or national codes, regulations, standards, permits, other requirements, and any Authority Having Jurisdiction (AHJ).

To help prevent injury and damage to the equipment, handle the unit, antennas, and other items with care and avoid dropping them.

Hardware Overview

Antenna and power cable requirements are reviewed below.

Table 4.1 Antennas, adhesive pad, and power cables

Item (part number)	Required for
<p>TGX Primary Antenna (17159196)</p> <p>Module contains three antennas; each antenna has its own cable which is suitable for only one TGX input: cellular, GPS, or LENS.</p>	<p>Cellular transmission, GPS reception, and LENS functionality.</p>
<p>TGX Satellite Antenna (17159693)</p>	<p>Satellite transmission</p>
<p>Adhesive pad for TGX antenna(s) (17159620)</p> <p>Thin, double-sided, adhesive, circular pad 54 mm diameter.</p>	<p>Optional, for mounting antennas when magnetic mounting is not available. Also orderable as a 10-piece kit (17159629).</p>
<p>TGX Gateway Power Cable (17159072)</p>	<p>Supplying power to the unit.</p>

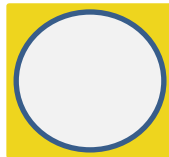

The TGX unique-to-unit values (e.g., serial number), mounting-plate fastener locations, inputs, and LED lights are identified in the figure below, which provides unit top, back, front, and side views.

Figure 4.1 TGX hardware overview

Top view: unit values and mounting plate features

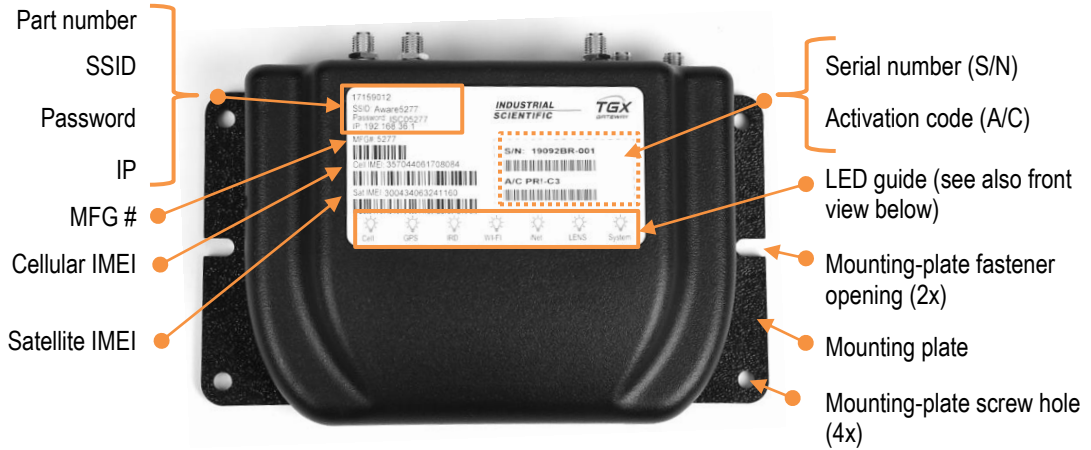

Back view: inputs

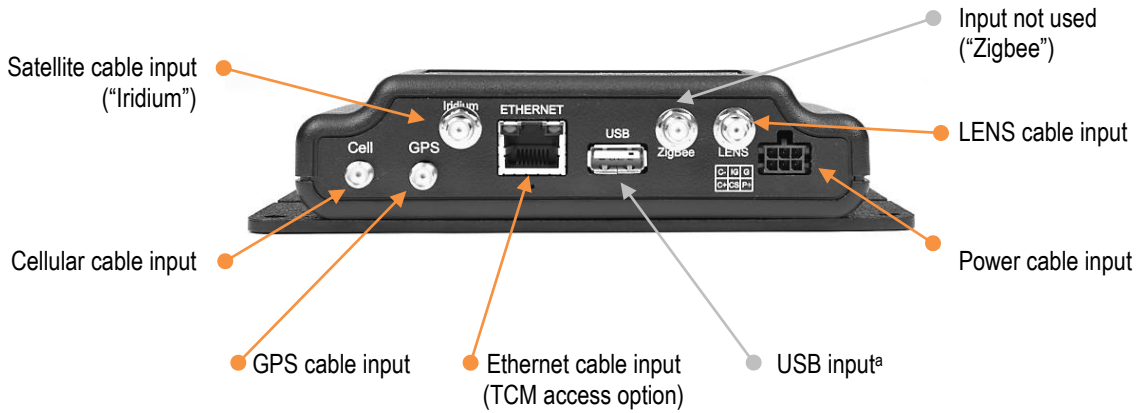

^aDo not use. For Industrial Scientific use only.

Front view: LED status indicators



Figure 4.1 TGX hardware overview

Side view: service input



Installation-site Precheck

Use the checklists below to ensure all the tasks described in Chapter 3 have been completed, you are properly equipped for installation, and you understand installation site requirements.

Tasks completed

TGX Gateway

- TGX activated
- TGX LENS-related settings entered in iNet Control

Ventis Pro

- LENS-related settings made
- Equipped with a fully-charged battery
- Not* monitored by another gateway or wireless battery

Note: It is recommended a Ventis Pro wireless battery *not* be used; however, if no other battery is available, turn off the battery's wireless feature through instrument settings.

Equipment required

- TGX Gateway
- TGX antennas
- TGX power cable
- This document (available at www.indsci.com/tgx)
- At least one smart device (computer, tablet, or smart phone)
- iNet® Control log-in credentials

Installation site requirements

- Wi-fi access to the internet
- Access to an outdoor location with unobstructed views of the sky above and surrounding horizon

TGX Mounting

Choose an in-vehicle mounting location that supports the safety of vehicle occupants and helps prevent damage to the TGX. Ensure the location and mount results meet the requirements listed below.

- Supports the intended routing, restraint, and enclosure of each 4 m long (13.1 ' long) power and antenna cable.
- Supports the weight of the unit and any added vehicle vibration that may occur during operation.
- Provides access to the installed unit for the connection or disconnection of cables.
- Provides access to view the installed unit's LED lights.
- Allows vehicle occupants to enter, exit, and be seated without disturbing the unit or its cables.
- Is unobtrusive to the vehicle operator and his or her field of view.
- Ensures no objects can be placed on top of the unit or its cables.
- Provides protection from moisture and excessive dust, dirt, and heat.
- Uses up to six fasteners in the mounting plate's predrilled holes, including the four corner holes.

Cable Installation

There are two distinct phases to cable installation: setup, then connection. **IMPORTANT:** Complete all setup and connection tasks in the order shown below with the vehicle engine *off*.

1. Setup
 - 1.1. Antenna module placement
 - 1.2. Antenna cable routing and restraint
 - 1.3. Power cable routing and restraint
2. Connection
 - 2.1. Power cable to vehicle
 - 2.2. Antenna cables to TGX
 - 2.3. Power cable to TGX

Setup

No connections are made during setup. Setup includes only the rooftop placement of antenna modules and the routing and restraint of the antenna and power cables.

Antenna module placement

To help prevent damage to the antenna modules and maintain their magnetic properties, avoid dropping the modules or subjecting them to significant physical impact.

When working with the antennas, the following also apply.

- Do not alter the modules or their cables.
- Do not drill or abrade the items; in powdered form, their magnet material is highly flammable.
- Use protective gloves and eyewear to avoid a potentially severe pinch injury, cut, or splinter.

To help prevent damage to the vehicle surface, gently place the antenna modules. When moving a module, do not slide the item; rather, lift it then gently replace it.

When placing the antenna module or modules, be sure to meet the requirements listed below.

- The antenna modules *must* be placed on the vehicle roof, which maximizes ground plane.
- Ensure the placement surface is clean and free of any metal objects.
- The magnetic modules will self-attract and attach to a metal roof surface; check for a solid, rigid connection.
- For a nonmetallic roof, use the included adhesive pads or consult with the installer for options that will provide a solid, rigid connection that is comparable to the pull force of each antenna's magnet (see [Specifications](#)).
- Ensure the antennas are placed using a vertical orientation, pointing to the sky.
- From the perspective of the antenna, maximize sight to the sky above and to the surrounding horizon.
- For compliance with FCC radio-frequency exposure limits, ensure a minimum distance of 20 cm (7.87") from each antenna to all persons.
- Place each module close to the point at which its cables will enter the vehicle interior.
- Place the two antenna modules parallel to each other; ensure a minimum distance of 0.6 m (24 ") between them to help prevent Radio Frequency Interference (RFI) during transmission.

Figure 4.2 Sample antenna placement

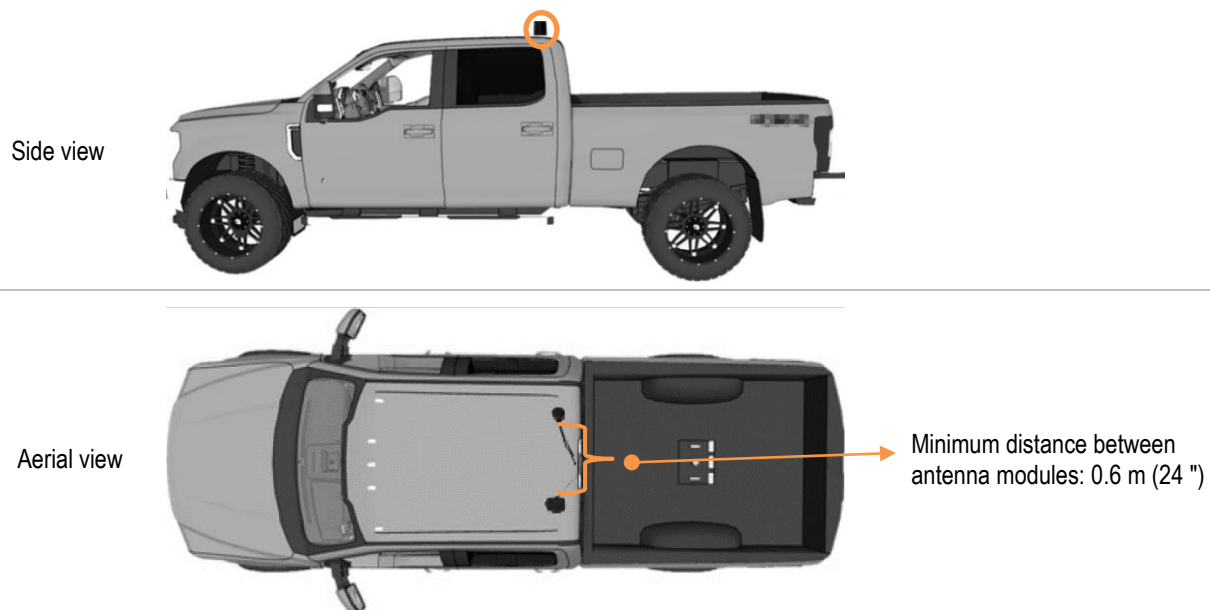

Antenna-cable routing and restraint

- ⚠ The antenna cables carry high-frequency signals; handle, install, and operate to prevent injury and damage to the cable.
- ⚠ The cable must be routed such that it will not be kinked, crushed, or subjected to repeated bending (e.g., by a vehicle door).

Route the antenna cables to reach the mounted TGX unit *but leave the cables unconnected*. When routing the cables, restrain and cover them to support the prevention of cable strain, damage, dislocation, or disconnection. The following apply:

- Do *not* add extensions to the cables and do not shorten the cables.
- The minimum cable bend radius is 6.4 mm (0.25 ").
- Ensure cables are protected from repeated bending or impact (e.g., by a vehicle door) after installation.
- Secure cables so they do not vibrate or move during vehicle operation.
- Protect the cables from chafing or abrasion at points of contact with surfaces.
- If a cable needs to be bent, avoid kinking it.
- Ensure cables are tension- and strain-free from connection to connection and during vehicle operation.
- Secure any excess cable length.
- Ensure vehicle occupants can enter, exit, and be seated without disturbing the cables.
- Ensure no objects can be placed on top of the cables.

Do not yet connect the antenna cables to the TGX.

Power-cable routing and restraint

When working with the power cable, apply these guidelines.

- Excess length may be trimmed from each wire's unterminated end.
- Ensure the cable is protected from repeated bending or impact after installation.
- Secure the cable so it does not vibrate or move during vehicle operation.
- Protect the cable from chafing or abrasion at points of contact with surfaces.
- If a cable needs to be bent, avoid kinking it.
- Ensure cable is tension- and strain-free from connection to connection and during vehicle operation.
- Ensure vehicle occupants can enter, exit, and be seated without disturbing the cable.
- Ensure no objects can be placed on top of the cable.

At this point, no connections have been made and all the following should have been completed:

- TGX mounted
- Antenna modules secured
- Antenna cables routed and restrained
- Power cable routed and restrained

Connections

IMPORTANT: *With the vehicle engine off*, complete connection tasks in this order:

1. Power-cable wires to vehicle
2. Antenna cables to TGX
3. Power cable to TGX

In the sections that follow, each nonvehicle required task is described in detail; vehicle-related tasks are the responsibility of the installer.

Connect power-cable wires to vehicle

Using the information supplied below, connect the three unterminated wires from the power cable. *Do not yet plug the cable into TGX.*

- ⚠ Ensure each power-cable wire is correctly connected to its one-and-only intended termination point. To help prevent damage to the vehicle's ignition system, fire, or another unsafe condition or undesired result, ensure each connection's integrity.
- ⚠ The TGX™ Gateway requires fused connections to the battery and ignition. *TGX does not support direct connections.*

Table 4.2 Power cable wires-to-vehicle connections and voltage requirements



TGX Gateway Power Cable (17159072)

Requirement	Value	Notes
<i>Connection</i>		
Red wire (battery)	<i>Only use a fused connection to the battery (+12VDC nominal); 5A fuse recommended.</i>	Supports the TGX keep-awake feature, which allows the TGX to remain on (for the customer set time period) after the vehicle is turned off.
White wire (ignition)	<i>Only use a fused connection to the ignition circuit; 1A fuse recommended, 5A (maximum).</i>	Signals to the TGX whether or not the vehicle engine is running.
Black wire	Main input power ground (0V)	For a vehicle with a non-steel frame (e.g., aluminum), consult the vehicle's manual or contact the vehicle manufacturer to identify an approved ground point.
<i>Voltage</i>		
Start-up	Minimum 10VDC required	The unit is generally operational within two to six minutes of starting the vehicle engine (one minute for start-up; up to five for operating-system bootup and wireless connections).
Operation	Minimum 12VDC required	

Connect cables to TGX

Use the information supplied below to identify each antenna cable and its matching SMA input on the back of the TGX. Connect all the antenna cables, then the power cable.

Figure 4.3 Cables-to-TGX connections

1 Connect *all* antenna cables.



TGX Primary Antenna
(17159196)

TGX Satellite Antenna
(17159693)



Cellular cable of primary antenna ("LTE")

Shown as packaged (above, left), the *primary* antenna has three cables; from left to right, they are Cellular, GPS, and LENS. While the cables appear identical, they are *not*, and they are *not interchangeable*. Each cable (Cellular shown) is labeled for its SMA input as indicated below.

Match each antenna cable to its one-and-only SMA input on the back of the unit (cellular shown).

When connecting a cable, use care not to bend its connector pin. Tighten each cable's swivel nut only by hand; this will help prevent cross threading or overtightening, both of which can damage the connectors or cables.

SMA input	Cable label text contains
Cellular	LTE
GPS	GPS
LENS	2.4/5.0 (or X.X/X.X)



Connect each remaining antenna cable for a total of four (cellular, GPS, LENS, and satellite [Iridium]).

Figure 4.3 Cables-to-TGX connections

2 Connect the power cable.

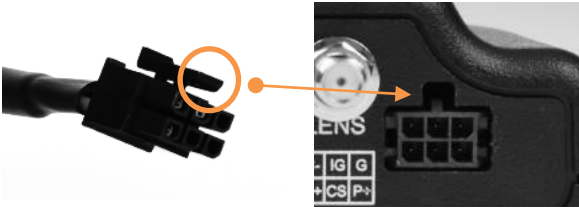

Note the power plug's locking prong.

Align the plug's locking prong with the *top* of the input.

Push the connector into the input until it clicks.

Test for a locked connection by gently pulling on the cable.



The unit is now ready for system validation. As a reminder, you will need the following.

- An internet connection
- iNet Control log-in credentials
- A smart-device (phone, computer, or tablet) with a browser
- A wi-fi or USB cable connection to access the TGX Configuration Manager (TCM)

System Validation

Overview

Power On

LED Check

Wireless Validation

Overview

System validation allows you to affirm that all work to this point has resulted in a successful installation and complete wireless functionality.

You will first verify the installed TGX™ Gateway is receiving power, and, if it is not, identify possible causes and remedies. After power is verified, functionality of cellular then satellite will be validated along with iNet Now and GPS. To support wireless verification, identify ahead of time a site that meets the requirements noted below.

- GPS requires an unobstructed view of the sky above.
- Satellite requires an unobstructed view of the sky above and of the surrounding horizon; avoid obstructions (e.g., buildings) that can block wireless signals.

System validation requires that the Ventis Pro have no connection to iNet Control *other than* through the installed TGX Gateway. To achieve this, take these precautions:

- Keep all other gateway units (TGX or RGX) well out of Ventis Pro range (100 m or 109 yd).
- Do *not* equip the Ventis Pro with a wireless battery; if no other battery is available, turn off the battery's wireless setting using instrument settings.

Power On

Start the vehicle engine to power on the installed TGX Gateway, which requires 10 VDC for start-up and 12 VDC for operation. The TGX will complete its start-up process, boot its operating system, and make its wireless connections, all within two to six minutes.

Important: When initially powering on the TGX, for proper operation, be sure to wait the recommended *two to six minutes* for the unit to receive an initial time update *before* connecting any LENS devices.

Figure 5.1 LED identifiers



Cellular

GPS

Satellite (IRD)

Wi-fi

iNet

LENS

System

Observe the LED lights on the TGX to verify the unit is receiving power.

If *any* LEDs turn on, the unit is receiving power; you do *not* need to review Table 5.1 below. Instead, continue with the section, [LED Check](#).

If *no* LEDs turn on, the unit is *not* receiving power. A checklist is provided below only for use by professionally trained automotive personnel. For assistance, [contact](#) Industrial Scientific.

Table 5.1 Identifying possible power connection issues

NOTICE: Only professionally trained automotive personnel should investigate, identify, and remedy any power-related issues, working in a nonhazardous area, using safe practices and equipment.

Step	Vehicle engine status	Guidelines
1	On	<p><i>Check power plug and “hard boot” the unit</i></p> <p>Check the power plug where it connects to the back of the TGX to ensure it is fully inserted and its locking prong is firmly in place. Recheck the LEDs; if no LEDs turn on, try a “hard boot”:</p> <ul style="list-style-type: none"> • Press down on the plug’s locking prong and remove the plug from its input. • Wait approximately 10 seconds. • Examine the interior of the plug and check its connector pins. <p>If the plug and its pins appear <i>undamaged</i>, reconnect the plug to its input on the back of the TGX, pushing the plug in until it clicks. Wait. If the power LED does not turn on within approximately one minute, complete the remaining power checks below.</p> <p>If the plug or its connector pins appear to be damaged, the power cable may need to be replaced. Remove the unit from service and contact Industrial Scientific.</p>
2	Off	<p><i>Fuse check</i></p> <p>Visually inspect the red and white wire fuses for the correct fuse size and evaluate the condition of the fuses.</p> <ul style="list-style-type: none"> • The <i>red</i> (battery) wire’s fuse should be 5A. • The <i>white</i> (ignition) wire’s fuse should be 1A fuse recommended, 5A (maximum). <p>If a fuse is <i>not</i> of the amperage noted above, replace it with a fuse that is.</p> <p>If a fuse appears burned, check the wiring from the vehicle battery or ignition to determine if the wire has shorted out or been otherwise damaged.</p> <ul style="list-style-type: none"> • If the wire is <i>not</i> damaged, replace the fuse with one of the amperage noted above.







Table 5.1 Identifying possible power connection issues

NOTICE: Only professionally trained automotive personnel should investigate, identify, and remedy any power-related issues, working in a nonhazardous area, using safe practices and equipment.

Step	Vehicle engine status	Guidelines
		<ul style="list-style-type: none"> If the wire is damaged, remove the unit from service until you can replace the TGX power cable. Contact Industrial Scientific.
3	On	<p><i>Voltage check</i></p> <p>Measure the voltage of each wire.</p> <ul style="list-style-type: none"> The red (battery) wire should produce a reading greater than or equal to 12VDC. The white (ignition) wire's reading should be similar to that of the red wire. The black wire should produce a zero reading. <p>If any of the readings do not match the values noted above, the installation of the power cable may be incorrect or the vehicle charging system is not delivering sufficient voltage.</p>
	Off	<p>If the wiring is <i>incorrectly</i> installed, examine the power cable for damage.</p> <ul style="list-style-type: none"> If <i>undamaged</i> reinstall as needed. If damaged, remove the unit from service until you can replace the TGX power cable. Contact Industrial Scientific. <p>Check the vehicle charging system and repair as needed.</p> <p><i>Note:</i> If the vehicle has a "smart alternator", it is possible that its lower voltage levels are at or lower than the unit's Critical Low Voltage setting. This can prevent TGX power on or power off. As needed, review this setting and consult the vehicle manufacturer for more information.</p>

LED Check

As noted below, each LED can be in a different state.

	Solid green		Solid amber		Solid red
	Blinking green		Blinking amber		Blinking red
	Off				

Some general LED patterns are described below.

- Lights are green with no red or amber lights*
If all lights are *solid* green for the unit's equipped, enabled functions, the unit is receiving power and is operational. When a wireless light is *blinking green*, the unit is transmitting data.
- The system light is green, but some lights are off*
If a feature is disabled or is not available for that unit, its indicator light is off. For example, the satellite LED will be off for a Cellular-only Unit.

- *The system light is green, but one or more lights is red or amber*
There is an error or issue, some of which are easily resolvable. For example, if the GPS LED is solid amber, the vehicle may be in a location where wireless signals are not accessible. Moving the vehicle may resolve the issue. For more information, see “[Table 5.2 LED indicators and what they mean](#)”.
- *No lights*
If no lights are on, the installed unit is *not* receiving power (see [Table 5.1 Identifying possible power connection issues](#)).
- *All lights are blinking green in unison*
If all lights are *blinking* green in unison, the unit is downloading a software update. *Do not* power off until after the pattern stops.
- *Green light appears to move from LED to LED*
If each LED is blinking green, one after the other in a repeating pattern, the unit is installing updates. *Do not* power off until after the pattern stops.

The table below defines the meaning of *each* color-pattern combination for *each* LED. For example, if the LENS LED is blinking green, LENS is on and transmitting data to iNet Control. Recommended actions are provided to help resolve issues; if an issue persists, [contact](#) Industrial Scientific.

Table 5.2 LED indicators and what they mean







Color-pattern	Operational status	Recommended actions
Cellular		
	Cellular is connected.	—
	Cellular is connected and the unit is transmitting data.	—
	Does not apply.	—
	Does not apply.	—
	Cellular is trying to connect.	The vehicle may be in a location where cellular service is not available. Use a cell phone to determine if service is available. If cellular service is <i>not</i> available, moving the vehicle may resolve the issue. If cellular service <i>is</i> available, see the section, Antenna or module error guidelines .
	SIM, antenna, or TGX module error.	See the section, Antenna or module error guidelines .
	Cellular is disabled.	Contact Industrial Scientific.

Table 5.2 LED indicators and what they mean



















Color-pattern	Operational status	Recommended actions
GPS		
	GPS is working and has 3D GPS lock.	—
	GPS is working (no 3D GPS lock).	The vehicle may be in a location with an obstructed view of the sky above; moving the vehicle may permit the 3D GPS lock.
	GPS is trying to connect.	The vehicle may be in a location where wireless signals are not available. GPS functionality requires an unobstructed view of the sky above; moving the vehicle may resolve the issue. Avoid metal objects near the roof-mounted antennas.
	Does not apply.	—
	Antenna or TGX module error.	See the section Antenna or module error guidelines .
	GPS is disabled.	Log into iNet Control and review GPS setting.
Satellite (Iridium)		
	Satellite is connected.	—
	Satellite is connected and the unit is transmitting data.	—
	Does not apply.	—
	Does not apply.	—
	Does not apply.	—
	Antenna or TGX module error.	See the section Antenna or module error guidelines .
	Satellite is disabled.	Contact Industrial Scientific.
Wi-fi		
	Wi-fi is available.	—
	Does not apply.	—
	Wi-fi is trying to connect.	Wait for a connection. If the issue persists, contact Industrial Scientific.
	Does not apply.	—
	Does not apply.	—
	Antenna or TGX module error.	Contact Industrial Scientific.

Table 5.2 LED indicators and what they mean























Color-pattern	Operational status	Recommended actions
	Wi-fi is disabled.	Use an Ethernet connection to log into the TCM and review the wi-fi setting; enable if needed.
iNet Control		
	iNet is connected.	—
	iNet is connected and transmitting data.	—
	iNet is trying to connect.	Wait for a connection. If the issue persists, contact Industrial Scientific.
	Does not apply.	—
	Does not apply.	—
	No iNet connection.	The vehicle may be in a location where wireless signals are not available. Moving the vehicle may resolve the issue. Avoid metal objects near the roof-mounted antennas. If the issue persists, contact Industrial Scientific.
	iNet is disabled.	Contact Industrial Scientific.
LENS		
	LENS is connected.	—
	LENS is connected and transmitting data.	—
	LENS is trying to connect.	Wait for a connection. If the issue persists, contact Industrial Scientific.
	Does not apply.	—
	LENS firmware is not operational.	A firmware upgrade may be needed. Check iNet Control or contact Industrial Scientific.
	Antenna or TGX module error.	See the section Antenna or module error guidelines .
	LENS is disabled.	Check the unit's settings in iNet Control. The TGX LENS Group and Encryption Key settings must match those of the instruments it is to monitor.
System		
	TGX is powered on.	—
	TGX is booting up.	Slow blinking green: the vehicle ignition is on. Fast blinking green: the vehicle ignition is off.
	TGX is starting up.	Wait. TGX is generally operational within two to six minutes.

Table 5.2 LED indicators and what they mean

Color-pattern	Operational status	Recommended actions
	TGX is operational	The vehicle ignition is off. The TGX is receiving power, based on its keep-awake settings, through its fused battery connection. The unit will power off after the keep-awake period concludes.
	Does not apply.	—
	TGX is in error.	Contact Industrial Scientific.
	The unit has been powered off or is not receiving power.	If the TGX should be receiving power but is not, see Table 5.1 Identifying possible power connection issues .

Antenna or module error guidelines

For an LED state that indicates an antenna or TGX module error, only professionally trained automotive personnel should use the guidelines below to examine the antenna's cable connection and condition. For assistance, [contact](#) Industrial Scientific.

Table 5.3 Identifying antenna or module error issues

NOTICE: Only qualified personnel should use these guidelines and attempt to identify or remedy any issues.

Step	Vehicle engine status	Guidelines
1	Off	Disconnect the power plug from the unit: At the top of the plug, depress its locking prong, then remove the plug.
2	Off	Validate the in-error antenna cable is connected to the correct input. Disconnect the cable and check its internal connector pin for damage. <ul style="list-style-type: none"> • If the pin is damaged, remove the unit from service and contact Industrial Scientific. • If the pin is <i>undamaged</i>, reconnect the antenna cable to its correct input and tighten the cable's swivel-nut connector only by hand.
3	Off	Check the antenna cable for strain, pinching, and damage. If damaged, remove the unit from service and contact Industrial Scientific; otherwise, correct any strain or pinch points and continue.
4	Off	Reconnect the power plug and start the vehicle's engine.
5	On	Allow up to six minutes for the TGX to complete its start-up, boot up, and make its wireless connections. Check the antenna's LED status. If the issue has not been resolved, contact Industrial Scientific.

Wireless Validation

After a satisfactory LED check, use the information below to complete wireless validation. The Industrial Scientific technical support team is available to assist from start to finish or at any time during the process. For assistance, [call](#) Industrial Scientific.

Figure 5.2 Wireless validation process





- 1 Disconnect the satellite cable from the back of the TGX as shown above; continue with steps 2 through 11.
- 2 Establish an internet connection on a computer or smart device. Log into iNet Control.
- 3 In iNet Control, access Live Monitoring through the thumbnail or from the iNet Now drop-down list.
- 4 Locate the Live Monitoring user card for the TGX (by serial number).
- 5 Power on the Ventis Pro: press and hold the power button  for approximately three seconds. The home screen will display when the instrument has completed its start-up sequence.
- 6 Verify the instrument's LENS connection to the TGX by repeatedly pressing the power button  until the *instrument's* LENS peer list is shown; validate the TGX serial number appears in the list.
- 7 In iNet Now, locate the user card for the Ventis Pro and verify the instrument's GPS location is accurate.
- 8 Press the instrument panic button and hold for approximately 3 seconds.

Figure 5.2 Wireless validation process

9

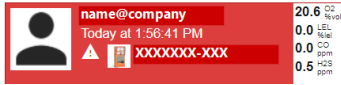

In iNet Now, verify the Ventis Pro user card is red and indicating a panic alarm .

10

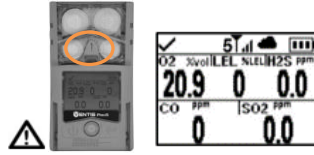

To turn off the panic alarm, press the instrument panic button.

11



On the back of the TGX, reconnect the satellite antenna.



On the front, check the satellite LED (third from left). Verify it is green, solid or blinking.

Operation, Service, and Warranty

Operation

Wireless Connections

Service

Power off

Warranty

Operation

Before putting the TGX™ Gateway into service, check its settings as instructed below and edit them as needed. Use the rest of this chapter to become familiar with the range guidelines that support LENS wireless connections between the TGX and other Industrial Scientific equipment items. Read and understand the service limitations, warranty, and limitation of liability as these things apply to the TGX.

Settings

There are several customer-editable settings, most of which have been previously discussed in this manual. These settings are defined below.

Keep awake

Enable the *keep-awake feature* to allow the TGX to continue operation after the vehicle engine is turned off. Set the desired amount of time the unit will run between engine shutdown and TGX power off; available values range from 1 to 240 minutes.

Note: When the TGX is operating in keep-awake state, it is powered by the fused vehicle-battery connection.

Critical low voltage

Battery-voltage needs vary by vehicle and can be affected by operating conditions, battery condition, and other factors. Use your knowledge of the vehicle's power system to set the battery voltage at which the TGX will power itself off, the *critical low voltage*. The value should reflect the minimum battery voltage needed to achieve the following:

- prohibit a running engine from the full loss of its battery power
- prohibit a nonrunning engine from completing an ignition cycle

Notes:

The critical low voltage feature overrides the keep-awake feature.

10 VDC is the minimum voltage required for TGX start-up.

If the vehicle has a “smart alternator”, it is possible that its lower voltage levels may be at or lower than the unit’s Critical Low Voltage setting. As needed, consult the vehicle manufacturer for more information.

If the vehicle’s battery becomes depleted below the *critical low voltage* threshold, to restore power to the TGX, you may need to disconnect, then reconnect the power cable to the unit.

LENS group

The TGX LENS group setting must be set to Scan or must match the *named group* value of the instruments it is intended to monitor. The value for a named group will be a single character in length; available values are letters A through J.

Encryption key

The TGX encryption key must match that of the instruments it is intended to monitor. A value of "default" sets the unit's LENS Wireless to the Industrial Scientific encryption key, and "custom" to the customer's key. To enter a custom key, use iNet® Control and follow the on-screen instructions.

GPS Interval

Set the interval at which the TGX will transmit its GPS location to iNet Control.

Settings apps

As indicated below, settings are maintained through two apps, iNet Control and the TGX Configuration Manager (TCM).

Table 6.1 Setting applications

	Application	
	iNet Control	TCM
Supported settings		
<i>LENS-related settings</i>		
LENS group or Scan	Yes	No
Encryption key	Yes	No
GPS interval	Yes	No
<i>Vehicle-related settings</i>		
Keep awake	No	Yes
Critical low voltage	No	Yes

iNet Control was used to set up TGX before installation (see [Settings](#)). Revisit iNet before deploying a unit for operation to review and edit any LENS-related settings.

Use the TCM app to edit vehicle-related settings. The TGX can connect to the TCM using an Ethernet or wi-fi connection. The wi-fi connection process is described below using a smart device (or computer) with a browser; the app is supported by Chrome and Firefox. Any values required by the TCM are supplied in the instruction below or are located on the unit’s (see [Figure 4.1 TGX hardware overview](#)). When using the TCM, the following apply:

- The logged-in user must have an *administrative* permission level.

- As with most applications, the TCM is subject to timing out when idle.
- When a data field appears in gray, the value cannot be edited by the customer.
- Use “enter” or other command buttons as you progress; follow any on-screen instruction to learn of and correct for any invalid or missing values.
- If any unresolvable issues are encountered, [call](#) the Industrial Scientific technical support team.

Figure 6.1 Vehicle-related settings using TGX Configuration Manager (TCM)

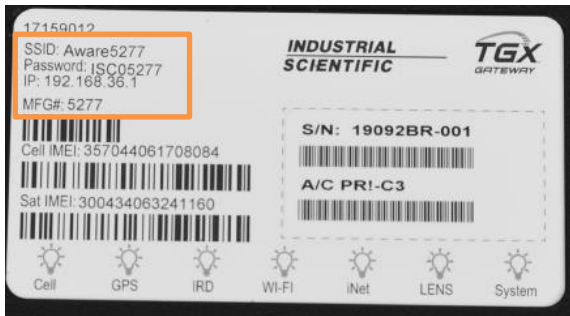

Locate and record the values listed below, which you will need to access and use the TCM. Each value is unique to a specific TGX unit and is printed on the label affixed to the top of the unit.

Value (format)

- SSID (AwareXXXX)
- Password (ISCXXXXX)
- IP (XXX.XXX.XX.X)



Power on the vehicle to power on the TGX.



On your smart device, go to Settings and locate the available wi-fi networks.

- Select the network name that matches the TGX unit's SSID (AwareXXXX).
- Log in to the network using the TGX unit's password (ISCXXXXX).

If you cannot log in, check the SSID and password values for accuracy and try again.



Access the TCM by opening a browser on the smart device.

- In the browser address bar enter `https://` followed by the unit's IP address (e.g., `XXX.XX.XX.X`).
- Press “enter”.

The TCM log-in screen will.

Log into the TCM using the “default” credentials:

- Username: user
- Password: user

Upon first login to the TCM, change the password.



Figure 6.1 Vehicle-related settings using TGX Configuration Manager (TCM)

After successfully changing your password, log out of the TCM and log in again with your new password.

Review the *Keep awake* and *Critical low voltage* settings; edit as needed.

Wireless Connections

LENS Wireless

LENS connections among peer equipment items are generally maintained, when no interference is present, by keeping the items within their range guidelines as outlined below.

Table 6.2 Range guidelines to maintain LENS Wireless connections

Equipment items	Line-of-sight distance, maximum
TGX Gateway to equipment items	
TGX to TGX	300 m (328 yd) ^a
TGX to RGX Gateway	300 m (328 yd) ^{a and b}
TGX Gateway to Ventis Pro	100 m (109 yd) ^a
TGX Gateway to Radius BZ1	300 m (328 yd) ^a
Instrument to instrument	
Ventis Pro to Ventis Pro	100 m (109 yd) ^c
Ventis Pro to Radius BZ1	100 m (109 yd) ^c
Radius BZ1 to Radius BZ1	300 m (328 yd) ^c

^aRequires installation of TGX Primary Antenna.

^bApplies when RGX power mode is set to World.

^cApplies when the equipment items face each other.

Cellular, GPS, and Satellite

During gateway or instrument operation, unintended interference can weaken wireless signals.

To ensure cellular connectivity, the vehicle in which the gateway is installed must be in a location where cellular service is available. You can use a cell phone to determine if cellular service is available in the area. Be knowledgeable of any dead zones that can interfere with cellular transmission.

- If cellular service is not available, moving the vehicle may resolve the issue.
- If cellular service is available, be sure to allow sufficient time for the TGX to complete its start-up, boot up, and make wireless connections (up to six minutes).

GPS and Satellite reception require outdoor, open-sky positioning with an unobstructed view of the sky above and of the surrounding horizon. Avoid obstructions (e.g., buildings) that can block wireless signals.

Service

The TGX™ Gateway exterior case, internal components, and items such as antennas and power cables from Industrial Scientific are *not* customer serviceable.

Power Off

To power off the unit, turn off the vehicle's engine. After the engine stops running, if the TGX keep-awake feature is enabled, the TGX will continue operation for the customer-set amount of time.

Warranty

Industrial Scientific Corporation's TGX™ Gateways are warranted to be free from defects in material and workmanship under normal and proper use and service for twenty-four (24) months from date of shipment.

Limitation of liability

THE WARRANTY SET FORTH ABOVE IS STRICTLY LIMITED TO ITS TERMS AND IS IN LIEU OF ALL OTHER WARRANTIES, GUARANTEES, EXPRESS OR IMPLIED, ARISING BY OPERATION OF LAW, COURSE OF DEALING, USAGE OF TRADE OR OTHERWISE. INDUSTRIAL SCIENTIFIC MAKES NO OTHER WARRANTIES, EITHER EXPRESSED OR IMPLIED, INCLUDING BUT NOT LIMITED TO THE WARRANTIES OF MERCHANTABILITY OR FITNESS FOR PARTICULAR PURPOSE. SHOULD THE PRODUCT FAIL TO CONFORM TO THE ABOVE WARRANTY, BUYER'S ONLY REMEDY AND INDUSTRIAL SCIENTIFIC'S ONLY OBLIGATION SHALL BE, AT INDUSTRIAL SCIENTIFIC'S SOLE OPTION, REPLACEMENT OR REPAIR OF SUCH NON-CONFORMING GOODS OR REFUND OF THE ORIGINAL PURCHASE PRICE OF THE NONCONFORMING GOODS. IN NO EVENT WILL INDUSTRIAL SCIENTIFIC BE LIABLE FOR ANY OTHER SPECIAL, INCIDENTAL, CONSEQUENTIAL, PUNITIVE OR OTHER SIMILAR DAMAGES, INCLUDING LOSS OF PROFIT OR LOSS OF USE, ARISING OUT OF THE SALE, MANUFACTURE OR USE OF ANY PRODUCTS SOLD HEREUNDER WHETHER SUCH CLAIM IS PLEADED IN CONTRACT OR IN TORT, INCLUDING STRICT LIABILITY IN TORT AND WHETHER INDUSTRIAL SCIENTIFIC HAS BEEN ADVISED OF THE POTENTIAL FOR SUCH DAMAGES. Industrial Scientific's total liability hereunder from any cause whatsoever (except liability from personal injury caused by Industrial Scientific's negligence), whether arising under contract, warranty, tort (including negligence), strict liability, products liability or any other theory of liability, will be limited to the lesser of Buyer's actual damages or the price paid to Industrial Scientific for the Products that are the subject of Buyer's claim. All claims against Industrial Scientific must be brought within one year after the cause of action arises, and Buyer expressly waives any longer statute of limitations. It shall be an express condition to Industrial Scientific's warranty that all products be carefully inspected for damage by Buyer upon receipt, be properly calibrated for Buyer's particular use, and be used, repaired, and maintained in strict accordance with the instructions set forth in Industrial Scientific's product literature. Repair or maintenance by non-qualified personnel will invalidate the warranty, as will the use of non-approved consumables or spare parts. As with any other sophisticated product, it is essential and a condition of Industrial Scientific's warranty that all personnel using the products be fully acquainted with their use, capabilities and limitations as set forth in the applicable product literature. Buyer acknowledges that it alone has determined the intended purpose and suitability of the goods purchased. It is expressly agreed by the parties that any technical or other advice given by Industrial Scientific with respect to the use of the goods or services is given without charge and at Buyer's risk; therefore, Industrial Scientific assumes no obligations or liability for the advice given or results obtained.

Contact Information

Industrial Scientific Corporation

1 Life Way

Pittsburgh, PA 15205-7500 USA

Web: www.indsci.com

Phone: +1 412-788-4353 or 1-800-DETECTS (338-3287)

Email: info@indsci.com

Fax: +1 412-788-8353

167 Provincial Avenue

Unit #170

Sherwood Park, Alberta T8H 0M3

Edmonton, AB, Canada

Phone: +1-780-467-2423

Fax: +1-780-467-2105

Email edmontonadmin@indsci.com

To locate a nearby distributor of our products or an Industrial Scientific service center or business office, visit us at www.indsci.com.

Rendez-vous sur notre site Web www.indsci.com, si vous voulez trouver un distributeur de nos produits près de chez vous, ou, si vous recherchez un centre de service ou un bureau Industrial Scientific.

INDUSTRIAL

SCIENTIFIC