

## Instruction Manual

---

# HI 2550

## Multiparameter pH/ORP/°C EC/TDS/NaCl Bench Meter

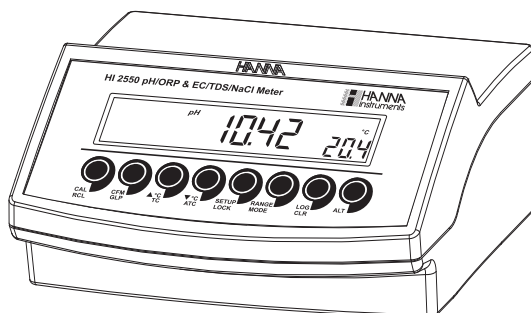

Dear Customer,  
 Thank you for choosing a Hanna Instruments product.  
 Please read this instruction manual carefully before using this instrument.  
 This manual will provide you with the necessary information for correct use of this instrument, as well as a precise idea of its versatility.  
 If you need additional technical information, do not hesitate to e-mail us at [tech@hannainst.com](mailto:tech@hannainst.com).

## WARRANTY

**HI 2550** is guaranteed for two years against defects in workmanship and materials when used for their intended purpose and maintained according to instructions. Electrodes and probes are guaranteed for six months. This warranty is limited to repair or replacement free of charge.

Damage due to accidents, misuse, tampering or lack of prescribed maintenance is not covered.

If service is required, contact the dealer from whom you purchased the instrument. If under warranty, report the model number, date of purchase, serial number and the nature of the problem. If the repair is not covered by the warranty, you will be notified of the charges incurred. If the instrument is to be returned to Hanna Instruments, first obtain a Returned Goods Authorization number from the Technical Service department and then send it with shipping costs prepaid. When shipping any instrument, make sure it is properly packed for complete protection.

## TABLE OF CONTENTS

WARRANTY .....	2
PRELIMINARY EXAMINATION .....	3
GENERAL DESCRIPTION .....	3
FUNCTIONAL DESCRIPTION .....	4
SPECIFICATIONS .....	5
OPERATIONAL GUIDE .....	7
AUTO-RANGING .....	12
pH CALIBRATION .....	13
pH BUFFER TEMPERATURE DEPENDENCE .....	18
RELATIVE mV CALIBRATION .....	19
ECS/TDS CALIBRATION .....	19
CONDUCTIVITY VERSUS TEMPERATURE CHART .....	21
NaCl CALIBRATION .....	22
GOOD LABORATORY PRACTICE (GLP) .....	23
LOGGING FUNCTION .....	28
SETUP .....	36
TEMPERATURE CALIBRATION (FOR TECHNICAL PERSONNEL ONLY) .....	42
mV CALIBRATION (FOR TECHNICAL PERSONNEL ONLY) .....	44
PC INTERFACE .....	45
ELECTRODE CONDITIONING & MAINTENANCE .....	51
TROUBLESHOOTING GUIDE .....	54
TEMPERATURE CORRELATION FOR pH SENSITIVE GLASS .....	55
ACCESSORIES .....	56

## PRELIMINARY EXAMINATION

Remove the instrument from the packing material and examine it carefully to make sure that no damage has occurred during shipping. If there is any damage, notify your Dealer or the nearest Hanna Customer Service Center.

Each instrument is supplied with:

- **HI 1131B** Glass-body Combination pH Electrode with 1 m (3.3') Cable
- **HI 76310** Conductivity / TDS probe
- **HI 7662** Temperature Probe
- **HI 76404N** Electrode Holder
- **pH 4.01 & 7.01** Buffer Solutions (20 mL each)
- **HI 7071** Electrolyte Solution
- 12VDC Power Adapter
- Instruction Manual

**Note:** Save all packing material until you are sure that the instrument functions correctly. All defective items must be returned in the original packing with the supplied accessories.

## GENERAL DESCRIPTION

The **HI 2550** is a microprocessor based pH, ORP, Conductivity (EC), TDS, NaCl, and Temperature Bench Meter. Relative mV feature is also provided.

pH measurements are compensated for temperature effect manually or automatically with the **HI 7662** temperature probe.

Up to a five-point pH calibration can be performed using seven standard buffers and two custom buffers.

A calibration due alarm can be set to alert the user that too much time has elapsed since the last pH calibration.

Conductivity and TDS features auto-ranging, which automatically selects the scale with the highest resolution. Conductivity measurements are compensated for temperature manually or automatically with a temperature sensor located inside the probe. The temperature coefficient is user selectable. Temperature compensation can be disabled to measure actual conductivity.

The **GLP** feature provides data consistency.

Data can be stored in the meters memory for later retrieval. The meters memory can hold 200 manually logged points and 500 lot logging points.

An USB connection ensures communication with a PC.

## FUNCTIONAL DESCRIPTION

### Front Panel

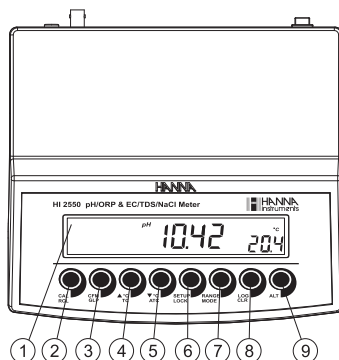

### Rear Panel

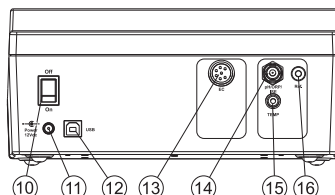

- 1) Liquid Crystal Display (LCD).
- 2) **CAL** key, to enter and exit calibration mode.  
**RCL** key (alternate function), to enter and exit memory recall.
- 3) **CFM/GLP** key, to confirm calibration selection, different setup values or to display Good Laboratory Practice information.
- 4) **▲°C** key, to manually increase temperature value or other parameters.  
**TC** key (alternate function), to view temperature coefficient value.
- 5) **▼°C** key, to manually decrease temperature value or other parameters.  
**ATC** key (alternate function), to select EC temperature compensation mode.
- 6) **SETUP** key, to enter/exit SETUP mode.  
**LOCK** key (alternate function), to freeze current EC range on the LCD.
- 7) **RANGE** key, to select measurement range (pH, mV, EC), switch to focused data in SETUP or toggle between buffer value and temperature during calibration.  
**MODE** key (alternate function) to select mV or Rel mV on mV range or EC, TDS, NaCl on EC range.
- 8) **LOG/CLR** key, to store a value into memory, to clear pH calibration, or to select to delete log records or lots.
- 9) **ALT** key, to select alternate function.
- 10) **ON/OFF** switch.
- 11) Power supply socket.
- 12) USB connector.
- 13) EC electrode connector.
- 14) BNC electrode connector.
- 15) Temperature probe socket.
- 16) Electrode reference socket.

## SPECIFICATIONS

<b>RANGE</b>	-2.0 to 16.0 pH -2.00 to 16.00 pH -2.000 to 16.000 pH
	±999.9 mV (ISE & ORP) ±2000 mV (ISE & ORP)
	0.00 to 29.99 $\mu\text{S}/\text{cm}$ 30.0 to 299.9 $\mu\text{S}/\text{cm}$ 300 to 2999 $\mu\text{S}/\text{cm}$ 3.00 to 29.99 $\text{mS}/\text{cm}$ 30.0 to 200.0 $\text{mS}/\text{cm}$ up to 500.0 $\text{mS}/\text{cm}$ uncompensated <sup>(*)</sup> conductivity
	0.00 to 14.99 ppm 15.0 to 149.9 ppm 150 to 1499 ppm 1.50 to 14.99 g/l 15.0 to 100.0 g/l up to 400.0 g/l uncompensated <sup>(*)</sup> TDS (with 0.80 factor)
	0.0 to 400.0% NaCl
	-20.0 to 120.0 °C (pH, EC range)
	-20.0 to 120.0 °C (pH, EC range)
<b>RESOLUTION</b>	0.1 pH 0.01 pH 0.001 pH
	0.1 mV ( $\pm 1000.0$ mV) 1 mV ( $\pm 2000$ mV)
	0.01 $\mu\text{S}/\text{cm}$ 0.1 $\mu\text{S}/\text{cm}$ 1 $\mu\text{S}/\text{cm}$ 0.01 $\text{mS}/\text{cm}$ 0.1 $\text{mS}/\text{cm}$
	0.01 ppm 0.1 ppm 1 ppm 0.01 g/l 0.1 g/l
	0.1% NaCl
	0.1 °C
	0.1 °C
<b>ACCURACY</b> @ 20°C / 68°F	±0.01 pH ±0.002 pH
	±0.2 mV ( $\pm 999.9$ mV) ±1 mV ( $\pm 2000$ mV)
	±1 % reading ( $\pm 0.05$ $\mu\text{S}/\text{cm}$ or 1 digit, whichever greater)
	±1 % of reading ( $\pm 0.03$ ppm or 1 digit, whichever greater)
	±1% of reading
	±0.4 °C (excluding probe error)

<sup>(\*)</sup> Uncompensated conductivity (or TDS) is the conductivity (or TDS) value without temperature compensation.

Rel mV offset range	±2000 mV
pH Calibration	1, 2, 3, 4 or 5 point calibration, 7 standard buffers available (1.68, 4.01, 6.86, 7.01, 9.18, 10.01, 12.45), and 2 custom buffers
EC Calibration	1 point slope calibration; 6 buffers available: 84.0, 1413 $\mu\text{S}/\text{cm}$ 5.00, 12.88, 80.0, 111.8 $\text{mS}/\text{cm}$ 1 point offset: 0.00 $\mu\text{S}/\text{cm}$
NaCl Calibration	1 point with <b>HI 7037L</b> buffer (optional)
Temperature compensation	Manual or Automatic from: –20.0 to 120.0 °C (pH RANGE) –20.0 to 120.0 °C (EC RANGE) (can be disabled on conductivity range to measure actual conductivity)
Conductivity temperature coefficient	0.00 to 6.00 $\%/^{\circ}\text{C}$ (for EC and TDS only) default value is 1.90 $\%/^{\circ}\text{C}$
TDS factor	0.40 to 0.80 (default value is 0.50)
pH Electrode	<b>HI 1131B</b>
EC Probe	<b>HI 76310</b>
Temperature probe	<b>HI 7662</b>
Input impedance (BNC input)	$10^{12}$ ohms
Log on demand feature	200 records
Log Interval feature	500 records Stability logging ("StAb"), 5, 10, 30 sec 1, 2, 5, 10, 15, 30, 60, 120, 180 min
PC communication	Optoisolated USB
Power supply	12 VDC adapter
Dimensions	235 x 222 x 109 mm (9.2 x 8.7 x 4.3")
Weight	1.3 Kg (2.9 lb); kit with holder 2.1 Kg (4.6 lb)
Environment	0 – 50 °C (32 – 122 °F) max. 95% RH non-condensing
Warranty	2 years

## OPERATIONAL GUIDE

### POWER CONNECTION

Plug the 12 VDC adapter into the power supply socket.

- Notes:**
- This instrument uses non volatile memory to retain the calibration parameters and all other settings, even when unplugged.
  - Make sure a fuse protects the main line.

### ELECTRODE AND PROBE CONNECTIONS

For pH or ORP measurements connect an electrode with internal reference to the BNC connector on the back of the instrument.

For electrodes with a separate reference connect the electrode's BNC to the BNC connector and the reference electrode plug to the reference socket.

For temperature measurements and automatic temperature compensation connect the temperature probe to the appropriate socket.

For EC/TDS measurements connect the probe to the 7-pin connector. Make sure the probe sleeve is properly inserted.

### INSTRUMENT START-UP

- Turn the instrument on by pressing the **ON/OFF** switch located on the rear panel.
- All LCD tags are displayed and a beep is sounded while the instruments perform a self test.



- The instrument will display "LoAd" message and "⌘" blinking until initialization is complete.

- Notes:**
- The instrument starts in the same range and mode as it was at power off.
  - The **ALT&MODE** keys change the measuring modes:
    - mV or Rel mV
    - EC or TDS or NaCl
  - The **RANGE** key toggles between measurement ranges:
    - pH, mV or Rel mV, EC or TDS or NaCl.

### pH MEASUREMENTS

Make sure the instrument has been calibrated before taking pH measurements.

- Submerge the electrode tip and the temperature probe approximately 3 cm (1 1/4") into the sample to be tested and stir gently. Allow time for the electrode to stabilize.

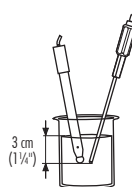

- The pH is displayed on the primary LCD and the temperature on the secondary LCD.



- If the reading is out of range, the closest full-scale value will be displayed blinking on the primary LCD.



If measurements are taken successively in different samples, it is recommended to rinse the electrode thoroughly with deionized water or tap water and then with some of the next sample to prevent cross-contamination.

The pH reading is affected by temperature. In order to measure the pH accurately, the temperature effect must be compensated for. To use the Automatic Temperature Compensation feature, connect and submerge the **HI 7662** temperature probe into the sample as close as possible to the electrode and wait for a few seconds.

If the temperature of the sample is known, manual temperature compensation can be used by disconnecting the temperature probe.

The display will show the last temperature reading with the "°C" tag blinking.

The temperature can now be adjusted with the **ARROW** keys (from -20.0 °C to 120.0 °C).



### mV/ORP MEASUREMENTS

An optional ORP electrode must be used to perform ORP measurements (see Accessories).

Oxidation-Reduction Potential (REDOX) measurements provide the quantification of the oxidizing or reducing power of the tested sample. The surface of the ORP electrode must be clean and smooth in order to obtain an accurate measurement.

- Press **RANGE** to enter mV range.
- Submerge the tip of the ORP electrode (3 cm/1 1/4") into the sample to be tested and allow a few seconds for the reading to stabilize.

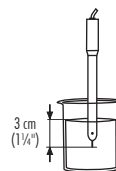



- The instrument displays the mV reading on the primary LCD and the temperature on the secondary LCD line.



- If the reading is out of range, the closest full-scale value will be displayed blinking on the primary LCD.



### RELATIVE mV MEASUREMENTS

- Press the **ALT&MODE** keys simultaneously while in mV range. The "rEL" and "mV" tags are displayed for about one second. After one second the temperature will be displayed on the secondary LCD and the "mV" tag will blink.



The reading displayed by the instrument is equal to the difference between the current mV input value and the relative mV offset established in the relative mV calibration.

### CONDUCTIVITY MEASUREMENTS

Connect the conductivity probe to the instrument.

- Press the **RANGE** key to enter conductivity measurement range (EC).
- Submerge the probe into the solution to be tested. The sleeve holes must be completely submersed. Tap the probe repeatedly to remove any air bubbles that may be trapped inside the sleeve.
- The conductivity value will be displayed on the primary LCD and the temperature on the secondary LCD.
- If the reading is out of range, the full-scale value (200.0 for MTC/ATC mode or 500.0 for actual conductivity) will be displayed blinking.



- If **LOCK** key was pressed and the reading goes out of range, the full-scale value of the frozen range will be displayed blinking.



The conductivity reading is affected by temperature.

Three options for temperature compensation are available in conductivity measurement mode.

**Automatic (ATC):** The conductivity probe has a built-in temperature sensor; the temperature value is used to automatically compensate the EC/TDS reading.

**Manual (MTC):** The temperature value, shown on the secondary LCD, can be manually set with the **ARROW** keys. The "°C" tag blinks when this option is active. This value will be used to compensate the EC/TDS reading.

**No Compensation (notc):** The temperature value is displayed, but not taken into account. When this option is selected the "°C" tag will blink with slower frequency. The reading displayed on the primary LCD is the uncompensated EC or TDS value.

To select the desired option, press the **ALT&ATC** keys until the option is displayed on the LCD.



**Notes:** • The default compensation mode is **ATC**.

- If no temperature probe is detected, **ATC** mode can not be selected and the instrument displays "----" on the secondary LCD.

If temperature compensation is selected, measurements are compensated using the temperature coefficient (default value 1.90 %/°C). To change the temperature coefficient, enter the setup mode and select "tc" (see **SETUP** for details, page 36). The current temperature coefficient can be quickly viewed by pressing the **ALT&TC** keys. The value is briefly displayed on the secondary LCD.

- If the temperature reading exceeds the limits of the meter (–20.0 °C to 120.0 °C), the "°C" tag will blink and the closest full scale value will be displayed.

### TDS MEASUREMENTS

Press the **ALT&MODE** keys while in EC range. The instrument will switch to TDS measuring range. The TDS reading will be displayed on the primary LCD and the temperature reading on the secondary LCD.



- If the reading is out of range, the full-scale value (100.0 for MTC/ATC mode or 400.0 for uncompensated TDS) will be displayed blinking.
- If **LOCK** was pressed and the reading goes out of range, the full-scale value of the frozen range will be displayed blinking.



### NaCl MEASUREMENTS

Press the **ALT&MODE** keys while in EC range until NaCl is displayed on the LCD. The instrument will display the NaCl reading on the primary LCD and the temperature reading on the secondary LCD line.



- If the reading is out of range, the full-scale value (400.0%) will be displayed blinking.

### TEMPERATURE MEASUREMENTS

In pH and ORP mode, connect the **HI 7662** temperature probe to the appropriate socket.

Submerge the temperature probe into the sample and allow the reading on the secondary LCD to stabilize.

In EC/TDS/NaCl range, the **HI 76310** probe has a built-in temperature sensor.

## AUTO-RANGING

The EC and TDS scales are auto-ranging. The meter automatically sets the scale with the highest possible resolution.

By pressing **ALT&LOCK**, the auto-ranging feature is disabled and the current range is frozen on the LCD. The "Auto" "Off" (auto-ranging disabled) tags will be displayed on the LCD for a few seconds. To restore the auto-ranging option, press **ALT&LOCK** again. The "Auto" "On" (auto-ranging enabled) tags will be displayed on the LCD for a few seconds.

**Note:** Auto-ranging is automatically restored if the range is changed, if the setup or calibration modes are entered and if the meter is turned off and back on again.

## pH CALIBRATION

Calibrate the instrument frequently, especially if high accuracy is required.

The instrument should be recalibrated:

- Whenever the pH electrode is replaced.
- At least once a day.
- After testing aggressive chemicals.
- If "CAL" "INTV" tags are blinking during measurement.

Every time you calibrate the instrument use fresh buffers and perform an electrode Cleaning Procedure (see page 53).

### PREPARATION

Pour small quantities of the buffer solutions into clean beakers. If possible, use plastic or glass beakers to minimize any EMC interferences.

For accurate calibration and to minimize cross-contamination, use two beakers for each buffer solution. One for rinsing the electrode and one for calibration.

If you are measuring in the acidic range, use pH 7.01 or 6.86 as first buffer and pH 4.01 as second buffer. If you are measuring in the alkaline range, use pH 7.01 or 6.86 as first buffer and pH 10.01 or 9.18 as second buffer.

### PROCEDURE

Calibration can be performed at up to five-points.

For accurate measurements, a three-point calibration is recommended.

The calibration buffer can be selected from the calibration buffer list that includes the custom buffers and the memorized standard buffers:

- pH 1.68, 4.01, 6.86, 7.01, 9.18, 10.01 and 12.45

The custom buffers allow the user to calibrate in a buffer solution different from a standard one. Up to two custom buffers can be set in SETUP menu (see page 36). Each custom buffer value can be changed in a  $\pm 1.0$  pH window around the set value, during calibration, when it is selected; the "BUFFER pH" tag will blink.

The instruments will automatically skip the buffer used during calibration and the buffers which are in a  $\pm 0.2$  pH window, around one of the calibrated buffers.

All new calibrations will override existing stored calibration data in a  $\pm 0.2$  pH window. The slopes adjacent to the new points will be reevaluated.

## FIVE-POINT CALIBRATION

- Submerge the pH electrode and the temperature probe approximately 3 cm (1¼") into a buffer solution and stir gently. The temperature probe should be close to the pH electrode.
- Press **CAL**. The "CAL" and "☰" tags will appear and the "7.01" buffer will be displayed on the secondary LCD.

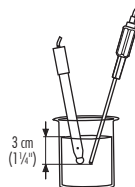

- If necessary, press the **ARROW** keys to select a different buffer value.
- The "☒" tag will blink on the LCD until the reading is stable.
- When the reading is stable and close to the selected buffer, the "READY" tag will be displayed and the "CFM" tag will blink.
- Press **CFM** to confirm calibration.
- The calibrated value is then displayed on the primary LCD and the second expected buffer value on the secondary LCD.



- After the first calibration point is confirmed, submerge the pH electrode and the temperature probe approximately 3 cm (1¼") into the second buffer solution and stir gently. The temperature probe should be close to the pH electrode.



- If necessary, press the **ARROW** keys to select a different buffer value.
- The "☒" tag will blink on the LCD until the reading is stable.
- When the reading is stable and close to the selected buffer, the "READY" tag will be displayed and the "CFM" tag will blink.
- Press **CFM** to confirm calibration.
- The calibrated value is then displayed on the primary LCD and the third expected buffer value on the secondary LCD.



- After the second calibration point is confirmed, submerge the pH electrode and the temperature probe approximately 3 cm (1¼") into the third buffer solution and stir gently. The temperature probe should be close to the pH electrode.

- If necessary, press the **ARROW** keys to select a different buffer value.
- The “**3**” tag will blink on the LCD until the reading is stable.



- When the reading is stable and close to the selected buffer, the “**READY**” tag will be displayed and the “**CFM**” tag will blink.



- Press **CFM** to confirm calibration.
- The calibrated value is then displayed on the primary LCD and the fourth expected buffer value on the secondary LCD.
- After the third calibration point is confirmed, submerge the pH electrode and the temperature probe approximately 3 cm (1 1/4”) into the fourth buffer solution and stir gently. The temperature probe should be close to the pH electrode.

- If necessary, press the **ARROW** keys to select a different buffer value.
- The “**3**” tag will blink on the LCD until the reading is stable.



- When the reading is stable and close to the selected buffer, the “**READY**” tag will be displayed and the “**CFM**” tag will blink.



- Press **CFM** to confirm calibration.
- The calibrated value is then displayed on the primary LCD and the fifth expected buffer value on the secondary LCD.
- After the fourth calibration point is confirmed, submerge the pH electrode and the temperature probe approximately 3 cm (1 1/4”) into the fifth buffer solution and stir gently. The temperature probe should be close to the pH electrode.

- If necessary, press the **ARROW** keys to select a different buffer value.
- The “**3**” tag will blink on the LCD until the reading is stable.



- When the reading is stable and close to the selected buffer, the “**READY**” tag will be displayed and the “**CFM**” tag will blink.



- Press **CFM** to confirm the fifth calibration point.
- The instrument stores the calibration value and returns to normal measurement mode.

#### **FOUR, THREE OR TWO-POINT CALIBRATION**

- Proceed as described in “**FIVE-POINT CALIBRATION**” section.
- Press **CAL** after the fourth, third or second calibration point was confirmed. The instruments will memorize the calibration data and return to measurement mode.

## ONE-POINT CALIBRATION

Two SETUP selectable options are available: "Pnt" and "OFFS".

If the "Pnt" option is selected, the new calibration point overrides an existing one. The adjacent slopes will be reevaluated.

If the "OFFS" option is selected, an electrode offset correction is performed.

The adjacent slopes will remain unchanged.

- Proceed as described in "FOUR, THREE or TWO-POINT CALIBRATION" section.
- Press **CAL** after the first calibration point was confirmed. The instruments will memorize the one-point calibration data and return to measurement mode.

- Notes:**
- If the value measured by the instrument is not close to the selected buffer, "WRONG" "☹" and "WRONG" "⚠" tags will blink alternately. Check if the correct buffer has been used, or clean the electrode by following the Cleaning Procedure (see page 53). If necessary, change the buffer or the electrode.
  - When a custom buffer is displayed, the "BUFFER pH" tag blinks. To change the custom buffer value in accordance with the buffer temperature proceed as described in "WORKING WITH CUSTOM BUFFERS" (see page 17).
  - If the buffer temperature or the manual temperature exceeds the temperature limits of the buffer, "WRONG" tag and temperature reading will blink.
  - If "WRONG", "BUFFER pH" tags and "OLD" message are displayed blinking on the secondary LCD line, an inconsistency between new and previous (old) calibration is detected. Clear calibration parameters and proceed with calibration from the current calibration point. The instrument will keep all confirmed values during current calibration.
  - To clear calibration parameters for all uncalibrated buffers starting with current buffer, press **CLR**. The calibration will continue from the current point. If this procedure is performed while calibrating in the first calibration point, the instrument returns to measurement mode.
  - Press **RANGE** to toggle between pH buffer, calibration buffer number and temperature reading.





- Each time a buffer is confirmed, the new calibration data replaces the old calibration data for the corresponding buffer. If current buffer has no previous data stored and the calibration is not full (five buffers), the current buffer is added to the existing calibration. If the existing calibration is full, the instrument asks which buffer to replace.



Press the **ARROW** keys to select another buffer to be replaced.

Press **CFM** to confirm the buffer that will be replaced.

Press **CAL** to leave calibration without replacing.

**Note:** If the replaced buffer is outside the  $\pm 0.2$  pH window, around each of the calibrated buffers, it is possible to select this buffer for next calibration during current calibration.

### WORKING WITH CUSTOM BUFFERS

If a custom buffer was set in **SETUP** menu, it can be selected during calibration by pressing the **ARROW** keys. The "BUFFER pH" tag will blink.

Press **SETUP** if you want to adjust the buffer value. The buffer value will



start blinking.

Use the **ARROW** keys to change the buffer value.

After 5 seconds, the buffer value is updated. Press **SETUP** if you want to change it again.

**Note:** Custom buffer value can be adjusted in a  $\pm 1.00$  pH window, around the set value.

## pH BUFFER TEMPERATURE DEPENDENCE

The temperature has an effect on pH. The calibration buffer solutions are affected by temperature changes to a lesser degree than normal solutions. During calibration the instrument will automatically calibrate to the pH value corresponding to the measured or set temperature.

TEMP		pH BUFFERS						
°C	°F	1.68	4.01	6.86	7.01	9.18	10.01	12.45
0	32	1.67	4.01	6.98	7.13	9.46	10.32	13.38
5	41	1.67	4.00	6.95	7.10	9.39	10.24	13.18
10	50	1.67	4.00	6.92	7.07	9.33	10.18	12.99
15	59	1.67	4.00	6.90	7.05	9.27	10.12	12.80
20	68	1.68	4.00	6.88	7.03	9.22	10.06	12.62
25	77	1.68	4.01	6.86	7.01	9.18	10.01	12.45
30	86	1.68	4.02	6.85	7.00	9.14	9.96	12.29
35	95	1.69	4.03	6.84	6.99	9.11	9.92	12.13
40	104	1.69	4.04	6.84	6.98	9.07	9.88	11.98
45	113	1.70	4.05	6.83	6.98	9.04	9.85	11.83
50	122	1.71	4.06	6.83	6.98	9.01	9.82	11.70
55	131	1.72	4.08	6.84	6.98	8.99	9.79	11.57
60	140	1.72	4.09	6.84	6.98	8.97	9.77	11.44
65	149	1.73	4.11	6.84	6.99	8.95	9.76	11.32
70	158	1.74	4.12	6.85	6.99	8.93	9.75	11.21
75	167	1.76	4.14	6.86	7.00	8.91	9.74	11.10
80	176	1.77	4.16	6.87	7.01	8.89	9.74	11.00
85	185	1.78	4.17	6.87	7.02	8.87	9.74	10.91
90	194	1.79	4.19	6.88	7.03	8.85	9.75	10.82
95	203	1.81	4.20	6.89	7.04	8.83	9.76	10.73

During calibration the instrument will display the pH buffer value at 25 °C.

## RELATIVE mV CALIBRATION

- Press **CAL** when the instrument is in RELATIVE mV measurement mode. The “mV” and “Σ” tags will be displayed. Absolute mV is displayed on the primary LCD and “Abs” message is displayed on the secondary LCD.
- When the absolute reading is stable and in measurement range, the instrument asks for confirmation.
- If the reading is out of range, “WRONG” tag will be displayed.
- Press **CFM** to confirm the absolute value. The instrument will display 0.0 mV on the primary LCD and “rEL” message on the secondary LCD. In this moment the relative mV offset is equal to absolute mV reading.
- Use the **ARROW** keys if you want to change the displayed relative mV value.
- Press **CFM** to confirm the relative mV value. The instrument returns to measurement mode.

**Note:** The relative mV value can be changed only inside the relative mV offset window ( $\pm 2000$  mV).

## EC/TDS CALIBRATION

Selectable calibration points for conductivity are 0.00  $\mu\text{S}$  for offset and 84.0  $\mu\text{S}$ , 1413  $\mu\text{S}$ , 5.00 mS, 12.88 mS, 80.0 mS, 111.8 mS for slope.

Rinse the probe with calibration solution or deionized water. Submerge the probe into the solution. The sleeve holes must be completely submerged. Tap the probe repeatedly to remove any air bubbles that may be trapped inside the sleeve.



To enter EC calibration, select the EC range and press **CAL**.



The “BUF” and “CAL” tags are displayed. The primary LCD will display the EC reading. The secondary LCD will display the value. The “Σ” and “~” tags will blink.

**Note:** The TDS reading is automatically derived from the EC reading and no specific calibration for TDS is needed. Pressing **CAL** when TDS range is selected has no effect.

For zero calibration, just leave the dry probe in the air. This calibration is performed in order to correct the reading at 0.00  $\mu\text{S}$ . The slope is evaluated when the calibration is performed at any other point.



Select the desired value with the **ARROW** keys, if necessary.



When the reading is stable, “READY” tag is displayed and “CFM” tag starts blinking on the LCD, asking for confirmation.



Press **CFM** to confirm calibration.

The instrument stores the calibration value and returns to measurement mode.



**Notes:** • If the reading is too far from the expected value, the “WRONG” and “☹️” tags will blink. Calibration can not be confirmed.

In this case check if the calibration solution has been used or clean the probe by following the Cleaning Procedure (see page 53).

- If the meter is in **ATC** mode and the buffer temperature is out of the 0.0 °C to 60.0 °C interval, “WRONG” “°C” tags and the temperature will blink.



- For best results choose an EC buffer value close to the sample to be measured.
- In order to minimize any EMC interference, use plastic or glass beakers.
- It is possible to set the cell constant value directly, without following the calibration procedure. To set the cell constant, enter **SETUP** mode and select “**CEL**” (see **SETUP** for details, page 36).

## CONDUCTIVITY VERSUS TEMPERATURE CHART

The conductivity of an aqueous solution is a measure of its ability to carry an electrical current by means of ionic motion.

The conductivity invariably increases with increasing temperature.

It is affected by the type and number of ions in the solutions and by the viscosity of the solution itself. Both parameters are temperature dependent. The dependency of conductivity on temperature is expressed as a relative change per Celsius degrees at a particular temperature, commonly as %/°C.

The following table lists the temperature dependence of HANNA EC calibration buffers.

°C	°F	HI7030 HI8030 (µS/cm)	HI7031 HI8031 (µS/cm)	HI7033 HI8033 (µS/cm)	HI7034 HI8034 (µS/cm)	HI7035 HI8035 (µS/cm)	HI7039 HI8039 (µS/cm)
0	32	7150	776	64	48300	65400	2760
5	41	8220	896	65	53500	74100	3180
10	50	9330	1020	67	59600	83200	3615
15	59	10480	1147	68	65400	92500	4063
16	60.8	10720	1173	70	67200	94400	4155
17	62.6	10950	1199	71	68500	96300	4245
18	64.4	11190	1225	73	69800	98200	4337
19	66.2	11430	1251	74	71300	100200	4429
20	68	11670	1278	76	72400	102100	4523
21	69.8	11910	1305	78	74000	104000	4617
22	71.6	12150	1332	79	75200	105900	4711
23	73.4	12390	1359	81	76500	107900	4805
24	75.2	12640	1386	82	78300	109800	4902
25	77	12880	1413	84	80000	111800	5000
26	78.8	13130	1440	86	81300	113800	5096
27	80.6	13370	1467	87	83000	115700	5190
28	82.4	13620	1494	89	84900	117700	5286
29	84.2	13870	1521	90	86300	119700	5383
30	86	14120	1548	92	88200	121800	5479
31	87.8	14370	1575	94	90000	123900	5575

## NaCl CALIBRATION

NaCl calibration is a one-point calibration at 100.0% NaCl. Use the **HI 7037L** calibration solution (sea water solution) as a 100% NaCl calibration solution.

Rinse the probe with some of the calibration solution or deionized water. Submerge the probe into **HI 7037L** solution. The sleeve holes must be completely submersed. Tap the probe repeatedly to remove any air bubbles that may be trapped inside the sleeve.

To enter NaCl calibration select the NaCl range and press **CAL**.



The “**BUF**” and “**CAL**” tags are displayed. The primary LCD will display the NaCl reading in percentage. The secondary LCD will display “**100**”.



The “**Σ**” and “**~**” tags will blink.

When the reading is stable, the “**READY**” tag will be displayed and the “**CFM**” tag starts blinking on the LCD, asking for confirmation.



Press **CFM** to confirm calibration.

The instrument stores the calibration value and returns to measurement mode.



- Notes:**
- If the reading is too far from the expected value, “**WRONG**” “**Σ**” tags will blink. Calibration cannot be confirmed.
  - If the temperature of the buffer is out of the 0.0 °C to 60.0 °C temperature interval, the “**WRONG**” and “**°C**” tags and the temperature will blink.
  - If a new EC calibration is performed, the NaCl calibration is automatically cleared. A new NaCl calibration is required.

## GOOD LABORATORY PRACTICE (GLP)

GLP is a set of functions that allows storage and retrieval of data regarding the maintenance and status of the electrode.

All data regarding pH, Rel mV, EC and NaCl calibration is stored for the user to review when necessary.

### EXPIRED CALIBRATION

For pH calibration, this instrument allows the user to set the number of days before the next required pH calibration. This value can be set from 1 to 7 days. The default setting is OFF (disabled).

When calibration has expired the "CAL" and "INTV" tags will blink to warn the user that the instrument should be recalibrated.

For example, if a 4 days time out has been selected, the instrument will issue the alarm exactly 4 days after the last calibration.

If the expiration value is changed (e.g. to 5 days), then the alarm will be immediately recalculated and appear 5 days after the last calibration.

**Note:** If the instrument was not calibrated, the "CAL" "INTV" tags will be displayed even if the feature is disabled in SETUP menu.

### pH CALIBRATION DATA

Calibration data is stored automatically after a successful calibration.

To view the pH calibration data, press **GLP** when the instrument is in pH (mV) measurement mode.

The instrument will display the time (hh:mm) of the last calibration.



Use the **ARROW** keys to scroll through the calibration data:

- The date (yyyy.mm.dd).



- The pH calibration offset.

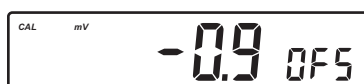

- The pH calibration slope (the GLP slope is the average of the calibration slopes; the percentage is referred to the ideal value of 59.16 mV/pH).



- The calibration buffers in order.

The first pH calibration buffer:



The second pH calibration buffer:



The third pH calibration buffer:



The fourth pH calibration buffer:



The fifth pH calibration buffer:



- Notes:**
- The "OLD" message displayed beside the pH value means that this buffer was not used during last calibration. Press and hold down the **SETUP** key if you want to see calibration date (or time if old calibration was performed on the same day as the current calibration).
  - If "no bUF" message appears on the LCD, the instrument informs you that calibration was performed in less than three points.



- Calibration Expiration status:  
- if disabled.





- or the number of days until the calibration alarm will be displayed.



- or if expired (7 days ago).



- The instrument ID.



### Relative mV CALIBRATION DATA

Relative mV calibration data is stored automatically after a successful calibration.

To view the Relative mV calibration data, press **GLP** when the instrument is in Relative mV measurement mode.

The instrument will display the time (hh:mm) of the last calibration.



Use the **ARROW** keys to scroll through the calibration data:

- The date (yyyy:mm:dd).



- The Relative mV calibration offset.



- The instrument ID.



## EC CALIBRATION DATA

EC calibration data is stored automatically after a successful calibration. To view the EC calibration data, press **GLP** when the instrument is in EC measurement mode. The instrument will display the time (hh:mm) of the last calibration.



Use the **ARROW** key to scroll through the calibration data:

- The date (yyyy:mm:dd).



- The EC calibration buffer.



- The cell constant.



- The calibration offset factor.



- The reference temperature.



- The temperature coefficient.



- The temperature compensation mode.



- The instrument ID.



### NaCl CALIBRATION DATA

NaCl calibration data is stored automatically after a successful calibration. To view the NaCl calibration data, press **GLP** when the instrument is in NaCl measurement mode.

The instrument will display the time (hh:mm) of the last calibration.



Use the **ARROW** key to scroll through the calibration data:

- The date (yyyy:mm:dd).



- The salinity coefficient.



- The cell constant.



- The reference temperature.



- The temperature compensation mode.



- The instrument ID.



- Notes:**
- If no temperature compensation is selected during calibration, the temperature coefficient is not displayed in GLP.
  - Press **GLP** at any moment and the instrument will return to measurement mode.
  - If calibration has not been performed on the selected range, the instrument displays “no CAL” message blinking.



## LOGGING FUNCTION

Up to 700 logged samples can be stored into memory. 200 manually logged records and 500 lot logging records can be stored in the memory. To select logging type enter SETUP menu.

### LOGGING THE CURRENT DATA (manual logging)

Select the manual logging mode in SETUP menu. To store the current reading into memory press **LOG** while the instrument is in measurement mode. The instrument will display “MA<sub>n</sub>” on the primary LCD, the record number on the secondary LCD and “LOG” tag for a few seconds (see example below: record No. 15):



followed by the number of free records:



If there are less than 6 memory locations remaining, the record number and "Lo" message will be displayed to alert the user.

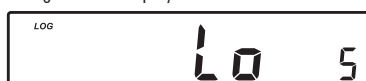

If the log space is full (200 records), "FULL LOG" message will be displayed and no more data will be saved.



When **LOG** is pressed, a complete set of information is stored: date, time, pH, mV, EC, TDS, NaCl temperature and calibration data.

### **LOT LOGGING**

Select "StAb" (stability logging) or the desired time interval.

To start interval logging press **LOG** key while the instrument is in measurement mode.

When the selected interval is reached or when the reading is stable (for log on stability), the instrument will display the current lot number on the primary LCD line, the record number on the secondary LCD line and the LOG tag (see example below: Lot 5 record 7)



followed by the number of free records on the corresponding memory space.



If stability logging is selected, a complete set of data is memorized every time the reading becomes stable after an unstable condition.

To stop interval logging press **LOG** key again. The "LOG" tag will be cleared.

**Note:** When pressing any key that is not active, while lot logging is running, the following message is displayed for a few seconds.



## VIEW LOGGED DATA

Press the **ALT&RCL** keys while in measurement mode to retrieve the stored information.

If no data was logged for the current selected measurement range and no lots are memorized, one of the next messages will be displayed:



No pH measurements records:



No Relative mV and mV records:



No EC records:



No TDS records:



No NaCl records:



Otherwise, the instrument will display the lot number on the primary LCD line, the number of records on the secondary, "LOG" tag and "CFM" blinking. If samples were logged on demand "MAN" will be displayed on the primary LCD and the number of samples logged on the secondary (see example below: manual log, 15 samples logged).



Press **ARROW** keys to select different lot.



Press **CFM** to view record information.

- If **RCL** was entered while in pH measurement range:



In Rel mV range:



In EC measurement range:



In TDS measurement range:



In NaCl measurement range:



Use the **ARROW** keys to scroll through the records.

**Note:** The instrument will automatically skip log records from other measurement ranges.

To view additional information press **RANGE**:

**For pH**

- The **mV** value on the primary LCD and the temperature value on the secondary LCD.



- The **time** on the primary LCD, along with "TIME" tag and the record number on the secondary LCD.



- The **date** on the primary LCD, along with "DATE" tag.



- The calibration **offset** on the primary LCD and "OFS" message on the secondary LCD.



- The calibration **slope** on the primary LCD and "SLP" message on the secondary LCD.



- The interval for lot logging.



To delete manual logged records: press **CFM** while "MAN" is displayed to view manually logged records. Press the **CLR** key, "dEL" and the record number will be displayed. Press **CFM** to delete. Use the **ARROW** keys to change the record number.

To delete a lot, use the **ARROW** keys to select the desired lot. Press **CLR** key, "dEL LOT" will appear on the display. Press **CFM** key to delete.



The "dEL" message is displayed on the primary LCD and the selected record on the secondary LCD, along with "LOG" tag.



- The **ARROW** keys can be used to change the record or lot number.
- Press **SETUP** to delete all records/lots. The display will show "dEL" in the primary LCD and "ALL" in the secondary LCD.



- Press **CFM** to confirm delete. While deleting the "X" tag will blink.
- Press **CAL** or **RANGE** or **CLR** to escape and return to the RCL screen.
- If "del ALL" option was selected, all the log on demand records or lots are deleted. While deleting the "X" tag is displayed blinking.
- Press **ALT&RCL** exit record information and enter lot information.
- Press **ALT&RCL** again to return to measurement mode.
- If one or more records/lots were deleted the "X" tag blinks until the log memory space is reorganized.

**Note:** If at least one record was deleted the log memory space will be recognized in about 4-5 seconds. During this period the "X" will blink.

#### For Relative mV and mV Range

- The temperature value, the mV absolute value, the time and the date as described above.
- The Relative mV offset.



#### For EC Range

- The time and date as described on pH Range.
- The EC on primary LCD and temperature value on the secondary LCD.
- The **offset factor** on the primary LCD and "OFS" message on the secondary LCD.



- The **cell constant** on the primary LCD and “CEL” message on the secondary LCD line.



- The **reference temperature** on the primary LCD and “rEF” message on the secondary LCD.



- The **temperature coefficient** on the primary LCD and “tc” message on the secondary LCD.



- The temperature compensation mode.



### For TDS Range

- The temperature reading as described in pH range.
- The **conductivity** value on the primary LCD and the temperature value on the secondary LCD.



- The time and the date as described in pH Range.
- The **TDS factor** on the primary LCD and “cF” message on the secondary LCD.



- The **reference temperature**, the **temperature coefficient**, the **temperature compensation mode** and the **cell constant** as described in EC Range.

### For NaCl Range

- The conductivity and temperature reading value as described in TDS Range.
- The time and date as described in pH Range.
- The **salinity factor** on the primary LCD and “cF” message on the secondary LCD, with “LOG” and “NaCl” tags displayed.
- The reference temperature, the temperature compensation mode and the cell constant message as described above.



**Note:** After LOG is pressed or “dEL” is confirmed, the instrument will display the amount of free log space for about one second (example 25 records free).



Press the **ALT&RCL** keys to leave RECALL mode at any time.

**Note:** When an information that does not display the record number is selected, pressing the **SETUP** key will display the record number on the secondary LCD line.

## SETUP

Setup mode allows viewing and modifying the following instrument parameters.

In accordance with the selected range, SETUP menu allows the possibility to view and/or change specific range parameters and common parameters (for all the ranges).

The common parameters are:

- Log interval
- Current Time (hour & minute)
- Current Date (year, month & day)
- Beep Status
- Instrument Id
- Temperature Unit

The specific parameters are:

### In pH range

- Expired Calibration Alarm
- First Custom Buffer
- Second Custom Buffer
- One-point Calibration Behavior
- pH Resolution

### In EC/TDS/NaCl range

- Cell Constant
- TDS Factor
- Temperature Compensation Coefficient
- Reference Temperature

To enter SETUP mode press **SETUP** while the instrument is in measurement mode.

Select a parameter with the **ARROW** keys.

Press **CAL** to change a parameter value. The selected parameter will start blinking.

Press **RANGE** to toggle between displayed parameters.

Press the **ARROW** keys to increase or decrease the displayed value.

Press **CFM** to save the modified value or **CAL** to escape without saving.

### EXPIRED CALIBRATION ALARM

Press **CAL** when the calibration time-out is displayed. Calibration time-out (“OFF” or “1” to “7” days) will start blinking.



Press the **ARROW** keys to change the calibration time-out value.

Press **CFM** to save the modified calibration time-out value.

Press **CAL** to escape without saving.

### LOG INTERVAL

Press **CAL** when log interval is displayed. The log interval is selected blinking (“MAN” for log on demand, “StAb” log on stability, interval in seconds or minutes).



Press the **ARROW** keys to change the custom buffer value.

Press **CFM** to confirm the selection.

Press **CAL** to escape without saving.

### FIRST CUSTOM BUFFER

Press **CAL** when “cb1” is displayed. The custom buffer (disabled — “no” or “0” to “16” pH) will start blinking.



Press the **ARROW** keys to change the custom buffer value.

Press **CFM** to save the modified custom buffer value.

Press **CAL** to escape without saving.

### SECOND CUSTOM BUFFER

Press **CAL** when “cb2” is displayed. The custom buffer (disabled — “no” or “0” to “16” pH) will start blinking.



Press the **ARROW** keys to change the custom buffer value.

Press **CFM** to save the modified custom buffer value.

Press **CAL** to escape without saving.

**Note:** To remove a custom buffer from the calibration list enter custom buffer press **CAL** key then press **CLR** key. The “no” “cb1” or “cb2” message will be displayed and the instrument return for the **SETUP** parameter scroll mode.

### ONE-POINT CALIBRATION BEHAVIOR

Press **CAL** when “1 Pnt” message is displayed on the secondary LCD. One of the two options (“Pnt” or “OFFS”) will start blinking (see pH CALIBRATION PROCEDURE for details, page 13).



Press the **ARROW** keys to toggle between “Pnt” and “OFFS” options. Press **CFM** to save the behavior for one-point calibration. Press **CAL** to escape without saving.

### pH RESOLUTION

Press **CAL** when “rES” message is displayed on the secondary LCD. The set resolution (“0.1”, “0.01” or “0.001”) will start blinking.



Press the **ARROW** keys to toggle between 0.1, 0.01 and 0.001 options. Press **CFM** to save the modified value. Press **CAL** to escape without saving.

### CURRENT TIME

Press **CAL** when the current time is displayed. The hour will start blinking.



Press the **ARROW** keys to change the hour. Press **RANGE**. The minutes will start blinking.



Press the **ARROW** keys to change the minutes. Press **CFM** to save the modified value. Press **CAL** to escape without saving.

### CURRENT DATE

Press **CAL** when the current date is displayed. The year will start blinking.



Press the **ARROW** keys to change the year.  
Press **RANGE**. The month will start blinking.



Press the **ARROW** keys to change the month.  
Press **RANGE**. The day will start blinking.



Press the **ARROW** keys to change the day.  
Press **CFM** to save the modified value.  
Press **CAL** to escape without saving.

### BEEP STATUS

Press **CAL** when the beep status is displayed. Beep status ("On" or "OFF") will start blinking.



Press the **ARROW** keys to change the beep status (On or OFF).  
Press **CFM** to save the modified beep status.  
Press **CAL** to escape without saving.

When enable, beep sounds as a short beep every time a key is pressed or when the calibration can be confirmed.

A long beep alert that the pressed key is not active or a wrong condition is detected while in calibration.

### INSTRUMENT ID

Press **CAL** when "InId" is displayed. The instrument ID ("0000" to "9999") will start blinking.



Press the **ARROW** keys to change the instrument ID value.

Press **CFM** to save the modified instrument ID value.

Press **CAL** to escape without saving.

**Note:** The instrument ID is downloaded to a PC as part of a logged data, set to identify its origin.

### TEMPERATURE UNIT

Press **CAL** when "tnP" is displayed. The temperature unit will start blinking.



Press the **ARROW** keys to change the option.

Press **CFM** to save the modified temperature unit.

Press **CAL** to escape without saving.

### CELL CONSTANT

Press **CAL** when the cell constant is displayed. The cell constant will start blinking.



Press the **ARROW** keys to change the cell constant (0.500 to 1.700).

Press **CFM** to save the modified cell constant.

Press **CAL** to escape without saving.



### TDS FACTOR

Press **CAL** when “tdS” is displayed. The TDS factor will start blinking.



Press the **ARROW** keys to change the TDS factor (0.40 to 0.80).

Press **CFM** to save the modified TDS factor.

Press **CAL** to escape without saving.

### TEMPERATURE COMPENSATION COEFFICIENT

Press **CAL** when the temperature compensation coefficient is displayed.

The temperature compensation coefficient will start blinking.



Press the **ARROW** keys to change the temperature compensation coefficient. (0.00 to 6.00 %/°C).

Press **CFM** to save the modified temperature compensation coefficient.

Press **CAL** to escape without saving.

### REFERENCE TEMPERATURE

Press **CAL** when the reference temperature is displayed. The reference temperature will start blinking.



Press the **ARROW** keys to toggle between 20.0 °C and 25.0 °C reference temperature value.

Press **CFM** to save the modified reference temperature value.

Press **CAL** to escape without saving.

## TEMPERATURE CALIBRATION (for technical personnel only)

The instrument has two temperature channels: one that measures the temperature from the **HI 7662** probe while the instrument is in pH/mV range and the other that measures temperature from the EC probe while the instrument is in EC/TDS/NaCl range.

All the instruments are factory calibrated for temperature on both channels. Hanna's temperature probes are interchangeable and no temperature calibration is needed when they are replaced.

If the temperature measurements are inaccurate, temperature recalibration should be performed.

For an accurate recalibration, contact your dealer or the nearest Hanna Customer Service Center, or follow the instructions below.

- Prepare a vessel containing ice and water and another one containing hot water (around 50 °C). Place insulation material around the vessels to minimize temperature changes.
- Use a calibrated thermometer with a resolution of 0.1 °C as a reference thermometer. Connect the **HI 7662** probe to the appropriate socket for the pH temperature channel or the **HI 76310** probe for the EC temperature channel.
- With the instrument off, press and hold down the **CFM & SETUP** keys, then power on the instrument to calibrate the pH temperature channel or **▲&RANGE** keys and then power on the instrument to calibrate the EC temperature channel. The "CAL" tag will appear and the secondary LCD will show "0.0 °C".



- Submerge the temperature probe (or EC probe) in the vessel with ice and water as near as possible to the calibrated thermometer. Allow a few seconds for the probe to stabilize.
- Use the **ARROW** keys to set the reading on the secondary LCD to that of ice and water, measured by the calibrated thermometer. When the reading is stable and close to the selected calibration point, "READY" tag will appear and "CFM" tag will blink.
- Press **CFM** to confirm. The secondary LCD will show "50.0 °C".

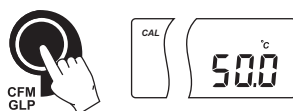

- Submerge the temperature probe (or EC probe) in the second vessel as near as possible to the calibrated thermometer. Allow a few seconds for the probe to stabilize.
- Use the **ARROW** keys to set the reading on the secondary LCD to that of the hot water.



- When the reading is stable and close to the selected calibration point, “READY” tag will appear and “CFM” tag will blink.
- Press **CFM** to confirm. The instrument memorize calibration and restart in measurement mode.



**Note:** If the reading is not close to the selected calibration point, “WRONG” tag will blink. Change the temperature probe (or EC probe) and restart calibration.

## **mV CALIBRATION (for technical personnel only)**

All the instruments are factory calibrated for mV.

Hanna's ORP electrodes are interchangeable and no mV calibration is needed when they are replaced.

If the mV measurements are inaccurate, mV recalibration should be performed.

For an accurate recalibration, contact your dealer or the nearest Hanna Customer Service Center or follow the instructions below.

A two-point calibration can be performed at 0.0 mV and 1800.0 mV.

- Attach to the BNC connector a mV simulator with an accuracy of  $\pm 0.1$  mV.
- With the instrument off, press and hold down the **CAL & ▼** keys, then power on the instrument. The "CAL" tag will appear and the secondary LCD will show "0.0 mV".
- Set **0.0 mV** on the simulator.

When the reading is stable and close to the selected calibration point, "READY" tag will appear and "CFM" tag will blink.

- Press **CFM** to confirm. The secondary LCD will display "1800 mV".
- Set **1800.0 mV** on the simulator.

When the reading is stable and close to the selected calibration point, "READY" tag will appear and "CFM" tag will blink.

- Press **CFM** to confirm. The instrument memorize calibration and restart to measurement mode.

**Notes:**

- If the reading is not close to the selected calibration point, "WRONG" tag will blink. Verify calibration condition or contact your vendor if you can not calibrate.

- Pressing **CAL** key during calibration process the instrument quit calibration mode and restart to measurement mode without memorizing calibration.

## PC INTERFACE

Data transmission from the instrument to the PC can be done with the HI 92000 Windows® compatible software (optional). HI 92000 also offers graphing and on-line help feature.

Data can be exported to the most popular spreadsheet programs for further analysis.

To connect your instrument to a PC, use a standard USB cable connector. Make sure that your instrument is switched off and plug one connector to the instrument USB socket and the other to the USB port of your PC.

**Note:** If you are not using Hanna Instruments HI 92000 software, please see the following instructions.

### SENDING COMMANDS FROM PC

It is also possible to remotely control the instrument with any terminal program. Use a standard USB cable to connect the instrument to a PC, start the terminal program and set the communication options as follows: 8, N, 1, no flow control, 9600 baud rate.

### COMMAND TYPES

To send a command to the instrument the scheme is:

<command prefix> <command> <CR>

where: <command prefix> is a selectable ASCII character between 0 and 47.

<command> is the command code (3 characters).

**Note:** Either small or capital letters can be used.

### SIMPLE COMMANDS

RNG	Is equivalent to pressing RANGE
CAL	Is equivalent to pressing CAL
CFM	Is equivalent to pressing CFM
UPC	Is equivalent to pressing the UP arrow key
DWC	Is equivalent to pressing the DOWN arrow key
SET	Is equivalent to pressing SETUP
LOG	Is equivalent to pressing LOG
MOD	Is equivalent to pressing MODE
GLP	Is equivalent to pressing GLP
CLR	Is equivalent to pressing CLR
RCL	Is equivalent to pressing RCL

**CHRxx** Change the instrument range according with the parameter value (xx):

- xx=00 pH range/0.001 resolution
- xx=01 pH range/0.01 resolution
- xx=02 pH range/0.1 resolution
- xx=03 mV range
- xx=04 Relative mV range
- xx=06 EC range
- xx=07 TDS range
- xx=08 NaCl range

The instrument sends the "ACK" (6) character every time a command is recognized and a "NAK" (21) character for invalid commands.

### **COMMANDS REQUIRING AN ANSWER**

**RAS** Causes the instrument to send a complete set of readings in according with the current range:

- pH, mV and temperature reading on pH range.
- mV and temperature reading on mV range.
- Rel mV, absolute mV and temperature reading on Rel mV range.
- Conductivity and temperature reading on EC range.
- TDS and temperature reading on TDS range.
- NaCl and temperature reading on NaCl range.

The answer string contains:

- Meter mode (2 chars):
  - 00 - pH range (0.001 resolution)
  - 01 - pH range (0.01 resolution)
  - 02 - pH range (0.1 resolution)
  - 03 - mV range
  - 04 - Rel mV range
  - 06 - EC range
  - 07 - TDS range
  - 08 - NaCl range
- Meter status (2 chars of status byte): represents a 8 bit hexadecimal encoding.
  - 0x10 - temperature probe is connected
  - 0x01 - new GLP data available
  - 0x02 - new SETUP parameter

- Reading status (2 chars): R - in range, O - over range, U - under range. First character corresponds to the appropriate range reading. Second character corresponds to mV reading (if exist).
- Primary reading (corresponding to the selected range) - 7 ASCII chars, including sign and decimal point.
- Secondary reading (only when primary reading is not mV, EC, NaCl, TDS) - 7 ASCII chars, including sign and decimal point.
- Temperature reading - 8 ASCII chars, with sign and two decimal points, always in °C.

MDR  
GLP

Requests the instrument model name and firmware code.

Requests the calibration data record.

The answer string contains:

- GLP status (1 char): represents a 4 bit hexadecimal encoding.
  - 0x01 - pH calibration available
  - 0x02 - Rel mV calibration available
  - 0x04 - EC calibration available
  - 0x08 - NaCl calibration available
- pH calibration data (if available), which contains:
  - the number of calibrated buffers (1 char)
  - the offset, with sign and decimal point (7 chars)
- the average of slopes, with sign and decimal point (7 chars)
- the calibration time, **yymmddhhmmss** (12 chars)
- buffers information (for each buffer)
  - type (1 char): 0 - standard, 1 - custom
  - status (1 char): N (new) - calibrated in last calibration; O (old) - from an old calibration.
  - warnings during calibration (2 chars): 00 - no warning, 04 - Clean Electrode warning.
  - buffer value, with sign and decimal point (7 chars).
  - the calibration time, **yymmddhhmmss** (12 chars).
- Rel mV calibration data (if available), which contains:
  - the calibration offset, with sign (7 chars)
  - the calibration time, **yymmddhhmmss** (12 chars).

- EC calibration data (if available), which contains:
  - the number of calibrated standards (1 char)
  - the offset factor, with sign and decimal point (7 chars)
  - the cell constant, with sign and decimal point (7 chars)
  - the calibration time, **yymmddhhmmss** (12 chars)
  - standards information (for each standard)
    - standard value, with sign and decimal point (7 chars).
    - buffer unit (2 chars; 00- $\mu$ S; 01-mS)
    - Reference Temperature with and decimal point (4 chars)
    - Temperature Compensation mode (2 chars)
      - 00 - no temperature compensation
      - 01 - automatic temperature compensation
      - 00 - manual temperature compensation
    - TC coefficient with sign and decimal point (4 chars)
    - calibration time, **yymmddhhmmss** (12 chars).
- Na Cl Calibration data
  - the number of calibrated data (1 char)
  - salinity coefficient, with sign and decimal point (7 chars)
  - Cell constant, with sign and decimal point (2 chars)
  - the calibration time (2 chars)
  - buffer information, for each buffer:
  - Reference Temperature with and decimal point (4 chars)
  - Temperature Compensation mode (2 chars)
    - 00 - no temperature compensation
    - 01 - automatic temperature compensation
    - 00 - manual temperature compensation
  - TC coefficient with sign and decimal point (4 chars)
  - calibration time, **yymmddhhmmss** (12 chars).

**PAR** Requests the setup parameters setting.

The answer string contains:

- Instrument ID (4 chars)



- Calibration alarm time out for pH range (2 chars)
- SETUP information (2 chars): 8 bit hexadecimal encoding.
  - 0x01 - beep ON (else OFF)
  - 0x04 - degrees Celsius (else degrees Fahrenheit)
  - 0x08 - Offset calibration (else Point calibration)
- The number of custom buffers (1 char)
- The custom buffer values, with sign and decimal point, for each defined custom buffer (7 chars)
- Log type 2 chars
  - 01 - manual log
  - 02 - stability lot log
  - 03 to 14 - the corresponding interval for lot log (5 s to 180 min)
- cell constant, with sign and decimal point (6 chars)
- TDS factor, with sign and decimal point (5 chars)
- TC coef, with sign and decimal point (5 chars)
- Reference Temperature, with sign and decimal point (5 chars)
- Temperature Compensation mode (1 char)

**NSLx** Requests the number of logged samples.

- x = P - request for pH range
- M - request for mV range
- E - request for EC range
- N - request for NaCl range
- T - request for TDS range

**LODxnnn:** request the "nnn" record of the manual log on the "x" range

**LODxALLff:** groups all Log On Demand Records in frames of 8 records each for the selected range

Command Parameters:

- x - range (see Note)
- ALL - download all records for the selected range
- ff - requested frame number - first frame is labeled 01

**LLsxff:** requests information about all lots on the specified range, it sends the information in frames of 10 lots each (a frame contains information about 10 lots)

Command Parameters:

- x - range (see Note)
- ff - requested frame number - first frame is labeled 01

**GLDxxxff:** Requests the records of the “xxx” lot number. The records are sent in frames of 10 records; “ff” is the frame number (01 first frame). (Example: Lot 13 has 53 records. The records will be sent in 6 frame, 5 with 10 records and 1 with 3 records.)

Command Parameters:

xxx - Lot number (eq; for lot number 1 xxx = 001)  
ff - requested frame number - first frame is labeled 01

- Errors:**
- “Err3” log on demand empty.
  - “Err4” requested set parameter is not available.
  - “Err5” command argument is wrong.
  - “Err6” requested range not available.
  - “Err7” meter in log mode.
  - “Err8” is sent if instrument is not in measurement mode.
  - “NAK” (21) character is sent when the instrument receives an unknown or a corrupted command.

**Note:** P - request for pH range.  
M - request for mV range.  
E - request for EC range.  
T - request for TDS range.  
N - request for NaCl range.

## ELECTRODE CONDITIONING & MAINTENANCE

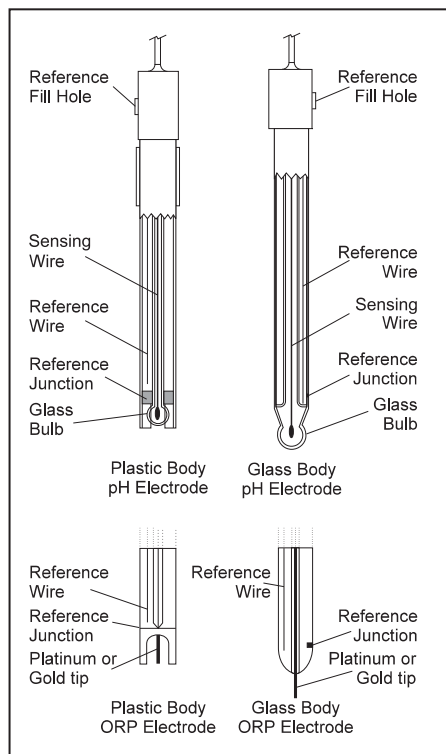

### PREPARATION PROCEDURE

Remove the protective cap of the pH electrode.

DO NOT BE ALARMED IF SALT DEPOSITS ARE PRESENT. This is normal with electrodes. They will disappear when rinsed with water.

During transport, tiny bubbles of air may form inside the glass bulb affecting proper functioning of the electrode. These bubbles can be removed by "shaking down" the electrode as you would do with a glass thermometer.

If the bulb and/or junction is dry, soak the electrode in **HI 70300** or **HI 80300** Storage Solution for at least one hour.

**For refillable electrodes:**

If the filling solution (electrolyte) is more than 2½ cm (1") below the fill hole, add **HI 7082** or **HI 8082** 3.5M KCl Electrolyte Solution for double junction or **HI 7071** or **HI 8071** 3.5M KCl + AgCl Electrolyte Solution for single junction electrodes.

For faster response, unscrew the fill hole screw during measurements.

**For AMPHEL® electrodes:**

If the electrode does not respond to pH changes, the battery is run down and the electrode should be replaced.

**MEASUREMENT**

Rinse the pH electrode tip with distilled water. Submerge the tip (3 cm/1¼") in the sample and stir gently for a few seconds.

For a faster response and to avoid cross-contamination of the samples, rinse the electrode tip with a few drops of the solution to be tested, before taking measurements.

Take care that the sleeve holes of the EC probe are completely submersed. Tap the probe repeatedly to remove air bubbles that may be trapped inside the sleeve.

**STORAGE PROCEDURE**

To minimize clogging and assure a quick response time, the glass bulb and the junction of pH electrode should be kept moist and not allowed to dry out.

Replace the solution in the protective cap with a few drops of **HI 70300** or **HI 80300** Storage Solution or, in its absence, Filling Solution (**HI 7071** or **HI 8071** for single junction and **HI 7082** or **HI 8082** for double junction electrodes). Follow the Preparation Procedure on page 53 before taking measurements.

**Note:** NEVER STORE THE ELECTRODE IN DISTILLED OR DEIONIZED WATER.

**PERIODIC MAINTENANCE**

Inspect the electrode and the cable. The cable used for connection to the instrument must be intact and there must be no points of broken insulation on the cable or cracks on the electrode stem or bulb. Connectors must be perfectly clean and dry. If any scratches or cracks are present, replace the electrode. Rinse off any salt deposits with water.

**pH Electrode Maintenance****For refillable electrodes:**

Refill the reference chamber with fresh electrolyte (**HI 7071** or **HI 8071** for single junction and **HI 7082** or **HI 8082** for double junction electrodes).

Allow the electrode to stand upright for 1 hour.

Follow the Storage Procedure above.

## pH ELECTRODE CLEANING PROCEDURE

- General Soak in Hanna HI 7061 or HI 8061 General Cleaning Solution for approximately ½ hour.
- Protein Soak in Hanna HI 7073 or HI 8073 Protein Cleaning Solution for 15 minutes.
- Inorganic Soak in Hanna HI 7074 Inorganic Cleaning Solution for 15 minutes.
- Oil/grease Rinse with Hanna HI 7077 or HI 8077 Oil and Fat Cleaning Solution.

**IMPORTANT:** After performing any of the cleaning procedures, rinse the electrode thoroughly with distilled water, refill the reference chamber with fresh electrolyte (not necessary for gel-filled electrodes) and soak the electrode in HI 70300 or HI 80300 Storage Solution for at least 1 hour before taking measurements.

## EC Probe Maintenance

Rinse the probe with clean water after measurements. If a more thorough cleaning is required, remove the probe sleeve and clean the probe with a cloth or a nonabrasive detergent. Make sure to reinsert the sleeve onto the probe properly and in the right direction. After cleaning the probe, recalibrate the instrument.

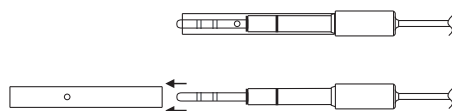

The platinum rings support is made of glass. Take great care while handling the probe.

## TROUBLESHOOTING GUIDE

SYMPTOMS	PROBLEM	SOLUTION
Slow response/excessive drift measuring pH.	Dirty pH electrode.	Soak the electrode tip in HI 7061 or HI 8061 for 30 minutes and then clean the electrode.
Readings fluctuate up and down (noise).	Clogged/dirty junction. Low electrolyte level (refillable pH electrodes only). EC probe sleeve not properly inserted; air bubbles inside sleeve.	Clean the electrode. Refill with fresh solution (for refillable pH electrodes only). Insert the sleeve. Tap the probe to remove air bubbles.
The meter does not accept the calibration solution for calibration.	Out of order pH electrode. Dirty electrode or contaminated calibration solution.	Follow the cleaning procedure. If still no results replace the electrode.
If the display shows: "pH" and "-2.00" or "16.00" blinking.	Out of range in the pH scale.	a) Recalibrate the meter. b) Make sure the pH sample is in the specified range. c) Check the electrolyte level and the general state of the electrode.
If the display shows: "mV" and "-2000" or "2000" blinking.	Out of range in the mV scale.	Electrode not connected. Verify that the electrode is connect.
The display shows EC, TDS or NaCl reading blinking.	Out of range in EC, TDS or NaCl scale.	Recalibrate the meter. Make sure the solution is in specified range. Make sure the LOCK key was not pressed.
The meter does not work with the temperature probe.	Broken temperature probe or wrong temperature probe used.	Replace the temperature probe.
The meter fails to calibrate or gives faulty readings.	Broken electrode.	Replace the electrode.
The meter fails to calibrate NaCl.	Incorrect EC calibration.	Recalibrate the meter in EC range. Set cell constant to 1.
At startup the meter displays all LCD tags permanently.	One of the keys is blocked.	Check the keyboard or contact the vendor.
"Err xx" error message displayed.	Internal error.	Power off the meter and then power it on. If the error persists, contact the vendor.

## TEMPERATURE CORRELATION FOR pH SENSITIVE GLASS

The resistance of glass electrodes partially depends on the temperature. The lower the temperature, the higher the resistance. It takes more time for the reading to stabilize if the resistance is higher. In addition, the response time will suffer to a greater degree at temperatures below 25 °C.

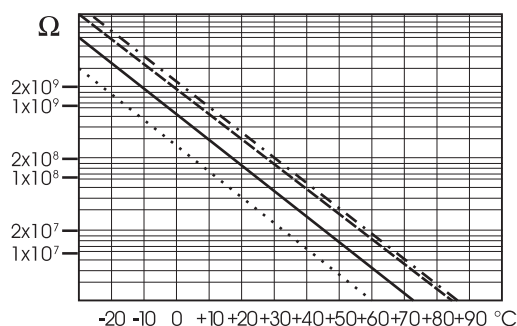

Since the resistance of the pH electrode is in the range of 50 – 200 Mohm, the current across the membrane is in the pico Ampere range. Large currents can disturb the calibration of the electrode for many hours. For these reasons high humidity environments, short circuits and static discharges are detrimental to a stable pH reading.

The pH electrode's life also depends on the temperature. If constantly used at high temperatures, the electrode life is drastically reduced.

### Typical Electrode Life

Ambient Temperature	1 – 3 years
90 °C	Less than 4 months
120 °C	Less than 1 month

### Alkaline Error

High concentrations of sodium ions interfere with readings in alkaline solutions. The pH at which the interference starts to be significant depends upon the composition of the glass. This interference is called alkaline error and causes the pH to be underestimated. Hanna's glass formulations have the indicated characteristics.

Sodium Ion Correction for the Glass at 20-25 °C		
Concentration	pH	Error
0.1 Mol L <sup>-1</sup> Na <sup>+</sup>	13.00	0.10
	13.50	0.14
	14.00	0.20
1.0 Mol L <sup>-1</sup> Na <sup>+</sup>	12.50	0.10
	13.00	0.18
	13.50	0.29
	14.00	0.40

## ACCESSORIES

### pH BUFFER SOLUTIONS

HI 70004P	pH 4.01 Buffer Sachets, 20 mL, 25 pcs
HI 70007P	pH 7.01 Buffer Sachets, 20 mL, 25 pcs
HI 70010P	pH 10.01 Buffer Sachets, 20 mL, 25 pcs
HI 7001L	pH 1.68 Buffer Solution, 500 mL
HI 7004L	pH 4.01 Buffer Solution, 500 mL
HI 7006L	pH 6.86 Buffer Solution, 500 mL
HI 7007L	pH 7.01 Buffer Solution, 500 mL
HI 7009L	pH 9.18 Buffer Solution, 500 mL
HI 7010L	pH 10.01 Buffer Solution, 500 mL
HI 8004L	pH 4.01 Buffer Solution in FDA approved bottle, 500 mL
HI 8006L	pH 6.86 Buffer Solution in FDA approved bottle, 500 mL
HI 8007L	pH 7.01 Buffer Solution in FDA approved bottle, 500 mL
HI 8009L	pH 9.18 Buffer Solution in FDA approved bottle, 500 mL
HI 8010L	pH 10.01 Buffer Solution in FDA approved bottle, 500 mL

### pH ELECTRODE STORAGE SOLUTIONS

HI 70300L	Storage Solution, 500 mL
HI 80300L	Storage Solution in FDA approved bottle, 500 mL

### CLEANING SOLUTIONS

HI 7061M	General Cleaning Solution, 250 mL bottle
HI 7061L	General Cleaning Solution, 500 mL bottle
HI 8061M	General Cleaning Solution, 250 mL bottle FDA approved bottle
HI 8061L	General Cleaning Solution, 500 mL bottle FDA approved bottle
HI 70000P	Electrode Rinse Sachets, 20 mL, 25 pcs
HI 7073L	Protein Cleaning Solution, 500 mL
HI 7074L	Inorganic Cleaning Solution, 500 mL
HI 7077L	Oil & Fat Cleaning Solution, 500 mL
HI 8073L	Protein Cleaning Solution in FDA approved bottle, 500 mL
HI 8077L	Oil & Fat Cleaning Solution in FDA approved bottle, 500 mL

### pH ELECTRODE REFILL ELECTROLYTE SOLUTIONS

HI 7071	3.5M KCl + AgCl Electrolyte, 4x30 mL, for single junction electrodes
HI 7072	1M KNO <sub>3</sub> Electrolyte, 4x30 mL
HI 7082	3.5M KCl Electrolyte, 4x30 mL, for double junction electrodes
HI 8071	3.5M KCl + AgCl Electrolyte in FDA approved bottle, 4x30 mL, for single junction electrodes
HI 8072	1M KNO <sub>3</sub> Electrolyte in FDA approved bottle, 4x30 mL
HI 8082	3.5M KCl Electrolyte in FDA approved bottle, 4x30 mL, for double junction electrodes



### ORP PRETREATMENT SOLUTIONS

HI 7091L Reducing Pretreatment Solution, 500 mL

HI 7092L Oxidizing Pretreatment Solution, 500 mL

### CONDUCTIVITY SOLUTIONS

HI 70030P 12880  $\mu\text{S}/\text{cm}$  ( $\mu\text{mho}/\text{cm}$ ), 20 mL sachets (25 pcs.)

HI 70031P 1413  $\mu\text{S}/\text{cm}$  ( $\mu\text{mho}/\text{cm}$ ), 20 mL sachets (25 pcs.)

HI 70033P 84  $\mu\text{S}/\text{cm}$  ( $\mu\text{mho}/\text{cm}$ ), 20 mL sachets (25 pcs.)

HI 70039P 5000  $\mu\text{S}/\text{cm}$  ( $\mu\text{mho}/\text{cm}$ ), 20 mL sachets (25 pcs.)

HI 7030M 12880  $\mu\text{S}/\text{cm}$  ( $\mu\text{mho}/\text{cm}$ ), 250 mL bottle

HI 7031M 1413  $\mu\text{S}/\text{cm}$  ( $\mu\text{mho}/\text{cm}$ ), 250 mL bottle

HI 7033M 84  $\mu\text{S}/\text{cm}$  ( $\mu\text{mho}/\text{cm}$ ), 250 mL bottle

HI 7030M 12880  $\mu\text{S}/\text{cm}$  ( $\mu\text{mho}/\text{cm}$ ), 250 mL bottle

HI 7034M 80000  $\mu\text{S}/\text{cm}$  ( $\mu\text{mho}/\text{cm}$ ), 250 mL bottle

HI 7035M 111800  $\mu\text{S}/\text{cm}$  ( $\mu\text{mho}/\text{cm}$ ), 250 mL bottle

HI 7039M 5000  $\mu\text{S}/\text{cm}$  ( $\mu\text{mho}/\text{cm}$ ), 250 mL bottle

HI 7030L 12880  $\mu\text{S}/\text{cm}$  ( $\mu\text{mho}/\text{cm}$ ), 500 mL bottle

HI 7031L 1413  $\mu\text{S}/\text{cm}$  ( $\mu\text{mho}/\text{cm}$ ), 500 mL bottle

HI 7033L 84  $\mu\text{S}/\text{cm}$  ( $\mu\text{mho}/\text{cm}$ ), 500 mL bottle

HI 7034L 80000  $\mu\text{S}/\text{cm}$  ( $\mu\text{mho}/\text{cm}$ ), 500 mL bottle

HI 7035L 111800  $\mu\text{S}/\text{cm}$  ( $\mu\text{mho}/\text{cm}$ ), 500 mL bottle

HI 7039L 5000  $\mu\text{S}/\text{cm}$  ( $\mu\text{mho}/\text{cm}$ ), 500 mL bottle

HI 7037L 100% NaCl sea water standard solution, 500 mL bottle

HI 8030L 12880  $\mu\text{S}/\text{cm}$  ( $\mu\text{mho}/\text{cm}$ ), 500 mL FDA approved bottle

HI 8031L 1413  $\mu\text{S}/\text{cm}$  ( $\mu\text{mho}/\text{cm}$ ), 500 mL FDA approved bottle

HI 8033L 84  $\mu\text{S}/\text{cm}$  ( $\mu\text{mho}/\text{cm}$ ), 500 mL FDA approved bottle

HI 8034L 80000  $\mu\text{S}/\text{cm}$  ( $\mu\text{mho}/\text{cm}$ ), 500 mL FDA approved bottle

HI 8035L 111800  $\mu\text{S}/\text{cm}$  ( $\mu\text{mho}/\text{cm}$ ), 500 mL FDA approved bottle

HI 8039L 5000  $\mu\text{S}/\text{cm}$  ( $\mu\text{mho}/\text{cm}$ ), 500 mL FDA approved bottle

### TDS SOLUTIONS

HI 70080C 800 ppm (mg/L), 20 mL (25 pcs.)

HI 70080P 800 ppm (mg/L), 20 mL (25 pcs.)

HI 70032C 1382 ppm (mg/L), 20 mL (25 pcs.)

HI 70032P 1382 ppm (mg/L), 20 mL (25 pcs.)

HI 77300C 1382 ppm (mg/L) & pH 7.01, 20 mL (10 pcs.)

HI 77300P 1382 ppm (mg/L) & pH 7.01, 20 mL (10 pcs.)

HI 70442C\* 1500 ppm (mg/L), 20 mL (25 pcs.)

HI 70442P\* 1500 ppm (mg/L), 20 mL (25 pcs.)

HI 77200C\* 1500 ppm (mg/L) & pH 7.01, 20 mL (10 pcs.)

HI 77200P\* 1500 ppm (mg/L) & pH 7.01, 20 mL (10 pcs.)

HI 7032M 1382 ppm (mg/L), 250 mL

HI 7032L 1382 ppm (mg/L), 500 mL

HI 70442M\* 1500 ppm (mg/L), 250 mL

HI 70442L\* 1500 ppm (mg/L), 500 mL

\* 1500 ppm TDS have an approximate conversion factor of:

0.65 ppm = 1  $\mu$ S/cm conversion rate.

### pH ELECTRODES

All electrodes part numbers ending in B are supplied with a BNC connector and 1 m (3.3') cable, as shown below :

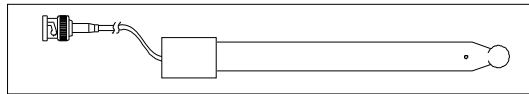

#### HI 1043B

Glass-body, double junction, refillable, combination pH electrode.

Use: strong acid/alkali.

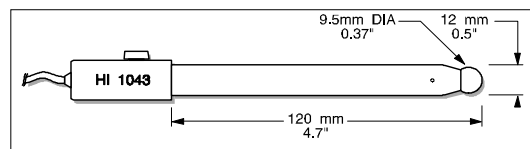

#### HI 1053B

Glass-body, triple ceramic, conic shape, refillable, combination pH electrode.

Use: emulsions.

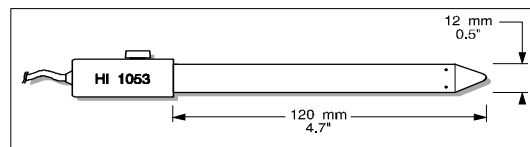

#### HI 1083B

Glass-body, micro, Viscolene, non-refillable, combination pH electrode.

Use: biotechnology, micro titration.

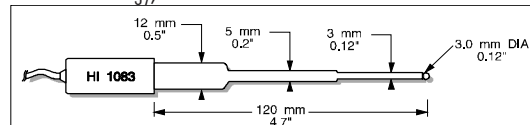

#### HI 1131B

Glass-body, single junction, refillable, combination pH electrode.

Use: general purpose.

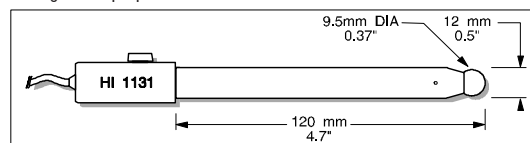

### HI 1330B

Glass-body, semimicro, single junction, refillable, combination pH electrode.

Use: laboratory, vials.

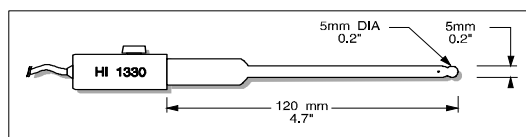

### HI 1331B

Glass-body, semimicro, single junction, refillable, combination pH electrode.

Use: flasks.

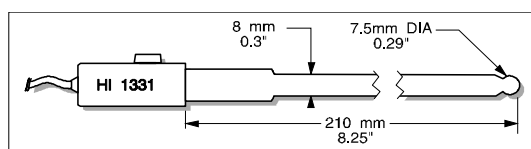

### HI 1230B

Plastic-body (PES), double junction, gel-filled, combination pH electrode.

Use: general, field.

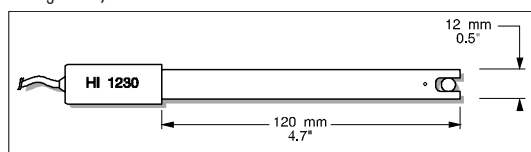

### HI 2031B

Glass-body, semimicro, conic, refillable, combination pH electrode.

Use: semisolid products.

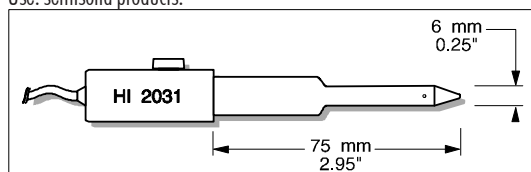

### HI 1332B

Plastic-body (PES), double junction, refillable, combination pH electrode.

Use: general purpose.

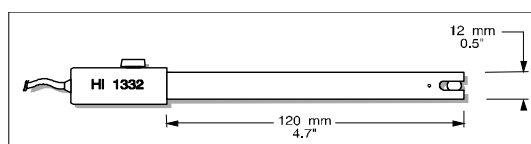

### FC 100B

Plastic-body (PVDF), double junction, refillable, combination pH electrode.  
Use: general purpose for food industry.

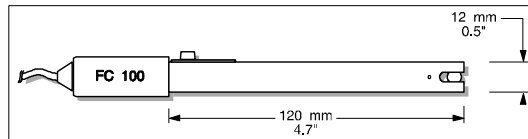

### FC 200B

Plastic-body (PVDF), open junction, conic, Viscolene, non-refillable, combination pH electrode. Use: meat & cheese.

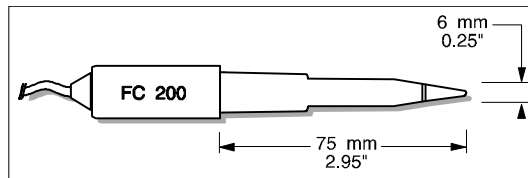

### FC 210B

Glass-body, double junction, conic, Viscolene, non-refillable, combination pH electrode. Use: milk, yogurt.

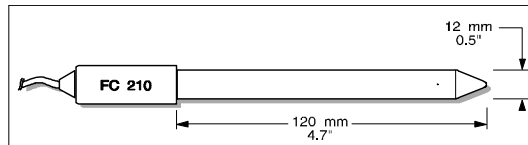

### FC 220B

Glass-body, triple-ceramic, single junction, refillable, combination pH electrode. Use: food processing.

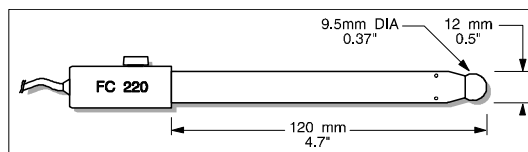

### FC 911B

Plastic-body (PVDF), double junction, refillable with built-in amplifier, combination pH electrode. Use: very high humidity.

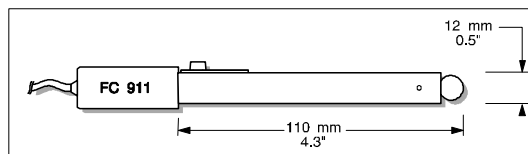

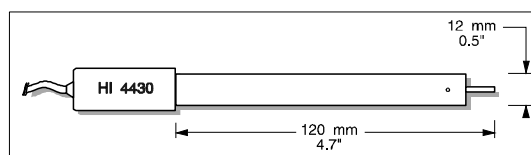
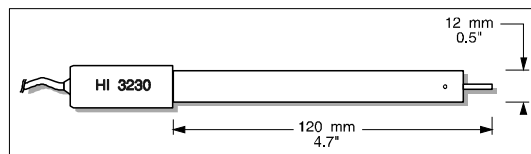
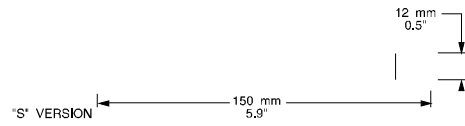

**EXTENSION CABLE FOR SCREW-TYPE ELECTRODES  
(SCREW TO BNC ADAPTER)**

HI 7855/1 Extension cable 1 m (3.3') long

HI 7855/3 Extension cable 3 m (9.9') long

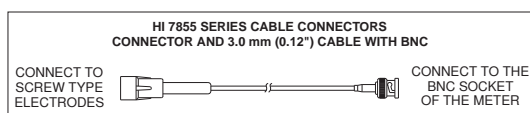

**OTHER ACCESSORIES**

HI 710005 Voltage adapter from 115 VAC to 12 VDC (USA plug)

HI 710006 Voltage adapter from 230 VAC to 12 VDC (European plug)

HI 710012 Voltage adapter from 240 VAC to 12 VDC (UK plug)

HI 710013 Voltage adapter from 230 VAC to 12 VDC (South Africa plug)

HI 710014 Voltage adapter from 230 VAC to 12 VDC (Australia plug)

ChecktempC Pocket-size thermometer (range -50.0 to 150.0 °C)

HI 76404N Electrode holder

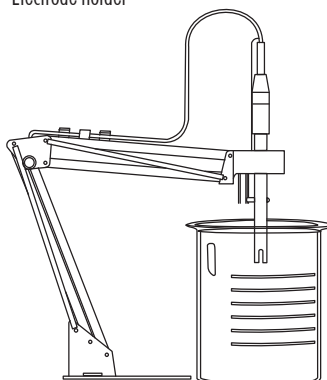

HI 8427 pH and ORP electrode simulator with 1 m (3.3') coaxial cable ending in female BNC connectors

HI 931001 pH and ORP electrode simulator with LCD and 1 m (3.3') coaxial cable ending in female BNC connectors

HI 76310 Platinum 4-ring conductivity/TDS probe with temperature sensor and 1 m (3.3') cable

HI 7662 Temperature probe with 1 m (3.3') cable

HI 92000 Windows® compatible software.

Windows® is registered Trademark of "Microsoft Co."

### **RECOMMENDATIONS FOR USERS**

Before using this product, make sure that it is entirely suitable for the environment in which it is used.

Operation of this instrument in residential areas could cause unacceptable interferences to radio and TV equipment, requiring the operator to follow all necessary steps to correct interferences.

The glass bulb at the end of the pH electrode is sensitive to electrostatic discharges. Avoid touching this glass bulb at all times.

During operation, ESD wrist straps should be worn to avoid possible damage to the electrode by electrostatic discharges.

Any variation introduced by the user to the supplied equipment may degrade the instrument's EMC performance.

To avoid electrical shock, do not use this instrument when voltages at the measurement surface exceed 24 VAC or 60 VDC.

To avoid damage or burns, do not perform any measurement in microwave ovens.

Hanna Instruments reserves the right to modify the design, construction and appearance of its products without advance notice.



**Hanna Instruments Inc.**  
Highland Industrial Park  
584 Park East Drive  
Woonsocket RI 028985 USA

**Local Sales and Customer Service office**

**Hanna Instruments United States Inc.**  
Highland Industrial Park  
584 Park East Drive  
Woonsocket RI 028985 USA  
Tel. (800) 426 6287  
Fax (401) 765 7575  
[www.hannainst.com/usa](http://www.hannainst.com/usa)

**Technical Support for customers**  
Telephone (800) 426 6287  
Fax (401) 765 7575  
E-mail [tech@hannainst.com](mailto:tech@hannainst.com)