

User Manual

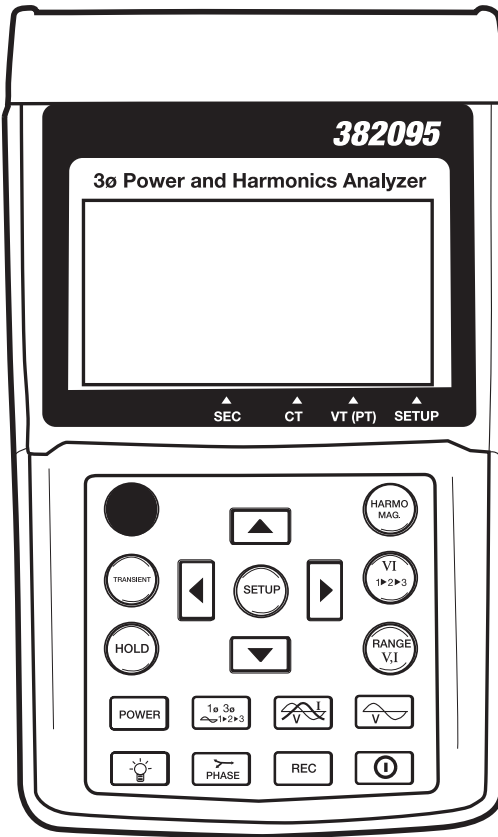

Power and Harmonics Analyzer Model 382095





EN 61010-2-032
CAT III 600V
Pollution Degree 2

Definition of Symbols:



Caution: Refer to Accompanying Documents



Caution: Risk of Electric Shock



Double Insulation

Over-voltage category III (CAT III): equipment in fixed installations.

WARNING: If the power analyzer is used in a manner not specified by the manufacturer, the protection provided by the clamp meter may be impaired.



Please read the following instructions before use

1. Do not operate this instrument in wet or dusty environments.
2. Do not operate this instrument in the presence of combustible or explosive gas
3. Do not touch exposed metal parts or unused terminals.
4. Consider the use of rubber gloves in operation.
5. Do not operate in excess of AC 500V (Phase to Neutral), or AC 600V (Phase to Phase)
6. Do not operate this instrument if it appears to be malfunctioning

Table of Contents

FEATURES	4
PANEL DESCRIPTION	5
OPERATING INSTRUCTIONS	10
Power Quality of a 3 Phase 4 Wire (3P4W) System	11
Power Quality of a 3 Phase 3 Wire (3P3W) System	12
Power Quality of a Single Phase (1P2W) System	13
Power Quality of a 1 Phase 3 Wire (1P3W) System	14
Measurement of a System with CT or VT	15
Harmonic Analysis of Voltage or Current	16
Display the Phase Angle of Harmonics	17
Measurement of Maximum Demand	18
Waveform of Voltage and Current	18
Waveform of Voltage Only	19
Graphic Phase Diagram	20
Phase Sequence of a 3 Phase System	21
Balanced and Unbalanced 3 Phase (3P3W, 3P4W) Power Source System	21
Balanced and Unbalanced 3 Phase (3P3W or 3P4W) Load System	22
Transient Capture (Dips, Swells, Outage)	23
Down Load Transient Data	24
Data Logging of Power Data (3P4W, 3P3W, 1P2W, 1P3W)	25
Down Load Power Data	25
Data Logging of Harmonics	25
Down Load Harmonics Data	26
HARDCOPY of SCREEN	27
READ the SAVED SCREEN	28
SET THE CT AND VT RATIO	29
SET THE TIME INTERVAL FOR MAXIMUM DEMAND	30
SET THE SAMPLING TIME FOR DATA LOGGING	31
SET THE CALENDER CLOCK	32
PROTOCOL OF RS-232C INTERFACE	33
SPECIFICATIONS	33
BATTERY REPLACEMENT	41
MAINTENANCE & CLEANING	42
Nomenclature	42

FEATURES

- Analysis for 3P4W, 3P3W, 1P2W, 1P3W
- True RMS value (V_{123} and I_{123})
- Active Power (W, KW, MW, GW)
- Apparent and Reactive Power (KVA, KVAR)
- Power Factor (PF), Phase Angle (Φ)
- Energy (WH, KWH, KVARH, PFH)
- Current measurement from 0.1mA to 1000A, capable of analyzing IT standby power consumption to the maximum demand of a factory
- Display of 35 Parameters in One Screen (3P4W)
- Programmable CT (1 to 600) and PT (1 to 3000) Ratios
- Display of Overlapped Voltage and Current Waveform
- Maximum Demand (MD KW, MW, KVA, MVA) with Programmable Period
- Harmonic Analysis (V_{123} and I_{123}) to the 99th Order
- Display of 50 Harmonics in one Screen with Waveform
- Display of Waveform with Peak Values (1024 Samples / Period)
- Analysis of Total Harmonic Distortion (THD-F)
- Graphic Phase Diagram with 3 Phase System Parameters
- Capture 28 Transient Events (Time + Cycles) with Programmable Threshold (%)
- DIP, SWELL, and OUTAGE are included in transient events.
- 3 Phase Voltage or Current Unbalanced Ratio (VUR, IUR)
- 3 Phase Voltage or Current Unbalanced Factor (d0%, d2%)
- Calculated Unbalanced Current through Neutral Line (In)
- 512K Memory with Programmable Interval (Sampling time from 2 to 6000 seconds, data logging time from 4.7 hours to 1180 days for 3P4W system)
- Output of Waveform, Power Parameters and Harmonics on Command
- Large Dot Matrix LCD Display with Backlight
- Optical Isolated RS-232C Interface

PANEL DESCRIPTION

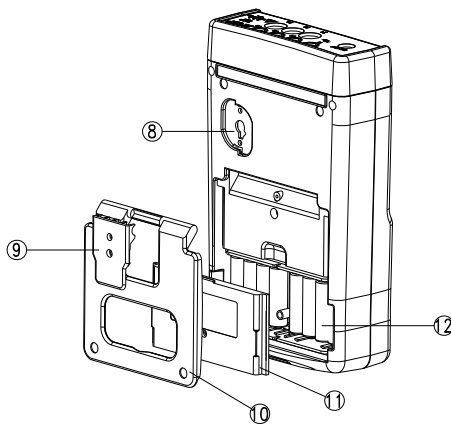
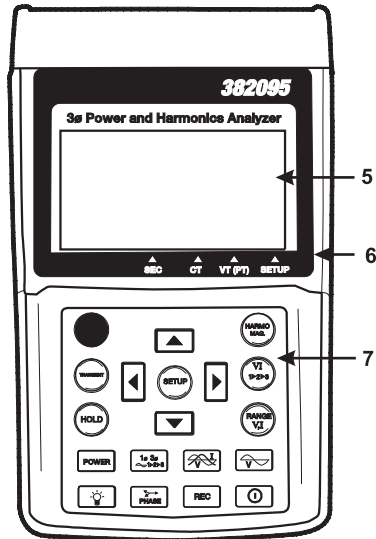
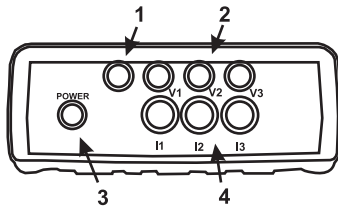

Panel Description

1. Input Terminal for Neutral Line (Voltage)
2. Voltage Input Terminals for Each Phase (V1, V2, V3)
3. External DC Input (The AC adaptor must be 600V isolated)
4. Current Input Terminals for Each Phase (I1, I2, I3)
5. LCD Display
6. Indication of locations where SEC., CT, VT, and SETUP are displayed in LCD.
7. Buttons
8. RS-232C Window
9. Stand Holder
10. Stand
11. Battery Cover
12. Battery Compartment

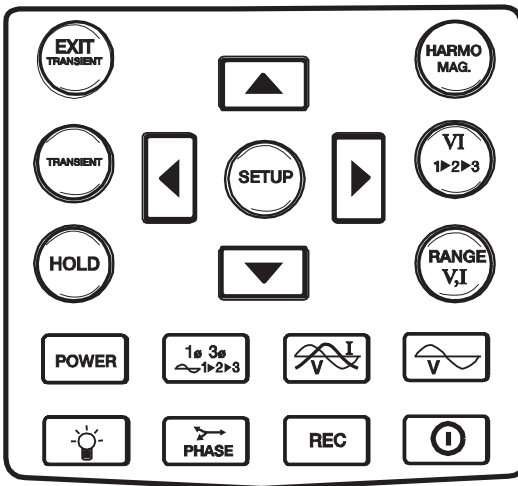

Press this button to exit transient detection mode. Also used to exit the SETUP menu



Press this button to perform transient detection



Press this button to hold the data displayed in LCD, press again to continue operation.



Press this button to begin the measurement of harmonics in magnitude.



Press this button to select V1, I1, V2, I2, V3, or I3 for harmonics analysis



Press this button for the voltage or current input range



Press to enter the Main Menu (also used to navigate menu items).



Press this button to increment value by one. Hold the button for two seconds or more to speed up the increment.



Press this button to decrement value by one.



In harmonic analysis mode, use these buttons to move the cursor left or right.



Press this button to start data logging. Press it again to stop data logging. The sampling interval is displayed in the LCD via the SEC indicator.



In the power mode, press this button to display the phase. In the harmonic analysis mode, press this button to display phase angle instead of magnitude.



Press this button to turn the back light on. Press it again to turn the back light off.



Press this button to begin measuring power.



Press this button to display the waveforms for voltage and current.



Press this button to display the waveform for voltage only



In the power mode, press this button to select the appropriate system (3P4W, 3P3W, 1P2W or 1P3W). In the waveform mode, press to select (V1, I1), (V2, I2), or (V3, I3).



Press this button to turn the power on or off.

Current Probe (100A)

1. Jaw Assembly
2. Trigger
3. Range Selector
4. 6 pin mini DIN connector

```
Down Load File: 1:19
REC DATE: 5- 7-22 10:14:50
HZ: 50
UT: 1
CT: 1
SEC: 2
CLAMP: 100
MD TIME: 15
TRANS REF:110.0 U
SDUP: 5%

Year Month Date Hour Minute Second
005 7 22 13 22 42
```

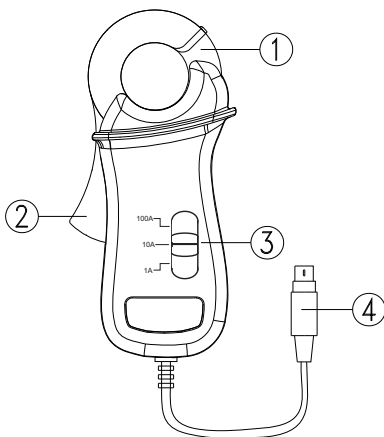

NOTE: To choose the 100A current probe, press the **SETUP** button to select CLAMP. When the CLAMP is reverse video, press the ▲ or ▼ button to select 100.

Current Probe (1000A)

1. Jaw Assembly
2. Trigger
3. Range Selector
4. 6 pin mini DIN connector

```
Down Load File: 1:19
REC DATE: 5- 7-22 10:14:50
HZ: 50
UT: 1
CT: 1
SEC: 2
CLAMP: 1000
MD TIME: 15
TRANS REF:110.0 U
SDUP: 5%

Year Month Date Hour Minute Second
005 7 22 13 21 16
```

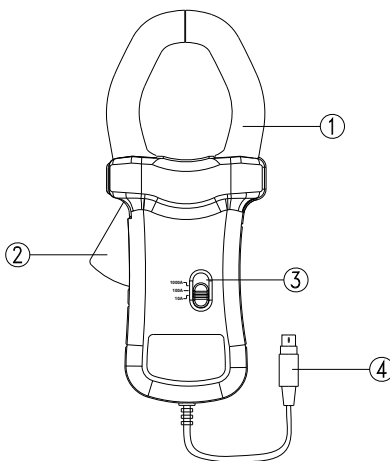

NOTE: To select the 1000A current probe, press the **SETUP** button to select CLAMP. When the CLAMP is reverse video, press the ▲ or ▼ button to select 1000.

Flexible Current Probe (3000A)

NOTE: The flexible current probe has a maximum input of 3000A however the maximum input current of the 382095 Power and Harmonics Analyzer is 1000A.

1. Control Box
2. Output Range Select Switch
3. Flexible Loop
4. Coupling Assembly

```
Down Load File: 1:19
REC DATE: 5- 7-22 10:14:50
HZ: 50
VT: 1
CT: 1
SEC: 2
CLAMP: 3000
MD TIME: 15
TRANS REF:110.0 V
SDUP: 5%

Year Month Date Hour Minute Second
2005 7 22 13 22 42
```

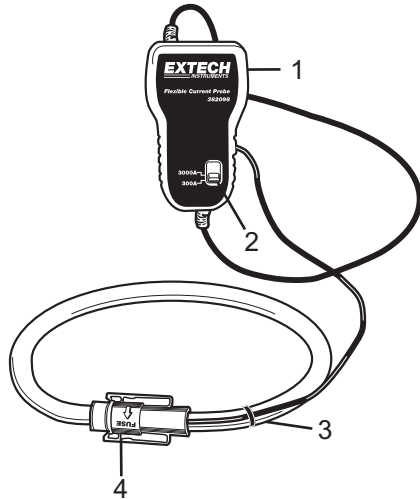

NOTE: To select

the 3000A flexible current probe, press the SETUP button to select CLAMP. When the CLAMP is reverse video, press the ▲ or ▼ button to select 3000.

OPERATING INSTRUCTIONS

NOTE: Select the correct CLAMP in the SETUP menu. When the current probe is connected to the power analyzer, the power analyzer will automatically detect the range selected.

NOTE: Select the correct frequency (Hz) in the SETUP menu.

```
Down Load File: 0 1:19
REC DATE: 5- 7-22 10:14:50
HZ:      50
UT:      1
CT:      1
SEC:     2
CLAMP:   100
MD TIME: 15
TRANS REF:110.0 U
SDUP:    5%

Year  Month  Date  Hour  Minute  Second
2005   7    22   13    22     42
```

WARNING: All the current probes connected to the power analyzer must be of the same model and same range. Mixed models and different ranges will yield incorrect measurement results.

Power Quality of a 3 Phase 4 Wire (3P4W) System

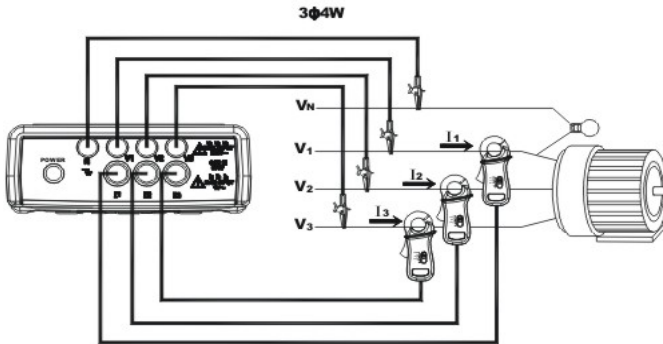

- Turn the power on. Press the **POWER** and the **1Φ3Φ** buttons to select the 3P4W system. The type of system will be displayed at the left bottom corner in the LCD.
- Connect the four test leads to the voltage terminals V1, V2, V3 and the V_N (Neutral) of the system.
- Connect the test leads to L1, L2, and L3 of the 3P4W system.
- Connect the three current probes to the power analyzer input terminal I1, I2, and I3.
- Clamp on to the L1, L2, and L3 of the 3P4W system. Make sure the current flows from the front of the current probe to the back.
- All of the system parameters will be shown in the LCD

U12 :381.6 U	U13 :219.9 U	I1 :799.1mA
U23 :381.1 U	U2 :219.9 U	I2 :800.1mA
U31 :379.1 U	U3 :219.5 U	I3 :800.7mA
P1 : 156.5 W	S1 : 175.7 VA	Q1 : -79.8 VAR
P2 : 154.0 W	S2 : 175.9 VA	Q2 : -84.9 VAR
P3 : 153.8 W	S3 : 175.7 VA	Q3 : -84.9 VAR
PΣ : 464.4 W	SΣ : 527.1 VA	QΣ : -249.4 VAR
PF2: 0.88	PF1: 0.89	PF2: 0.87
PF3: 0.88	φ1: -26.9°	φ2: -29.0°
φ3: -29.0°		
WH :127.7 WH	SH :144.8 VARH	QH : 68.2 VARH
H2 : 50.0 H	MOB :436.5 VA	MOB :385.1 W
3P4W	SEC: 2	CT: 1
	VT: 1	

For a description of each parameter, refer to section XIV. NOMENCLATURE.

Power Quality of a 3 Phase 3 Wire (3P3W) System

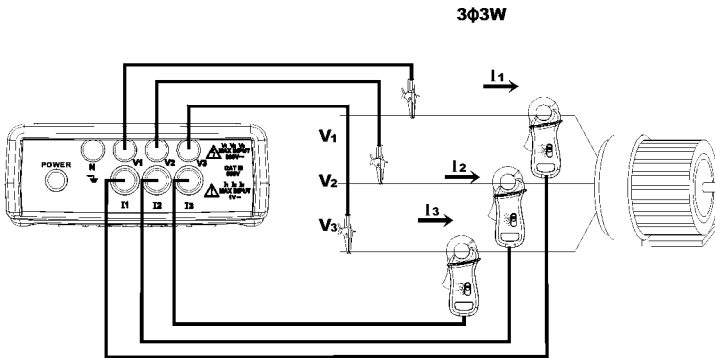

- Turn the power on. Press the **POWER** and the **1Φ3Φ** buttons to select the 3P3W system. The type of system will be displayed at the bottom right of the LCD.
- Connect the four test leads to the voltage terminals L1, L2, and L3 of the system.
- Connect the three current probes to the power analyzer input terminal I1, I2, and I3.
- Clamp on to the L1, L2, and L3. Make sure the current flows from the front of the current probe to the back.
- All parameters of the system will be shown in the LCD

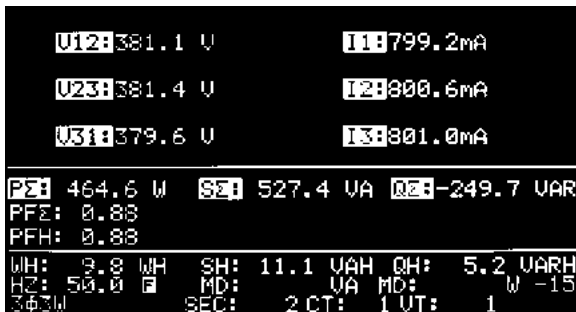

For a description of each parameter, refer to XIV. NOMENCLATURE.

Power Quality of a Single Phase (1P2W) System

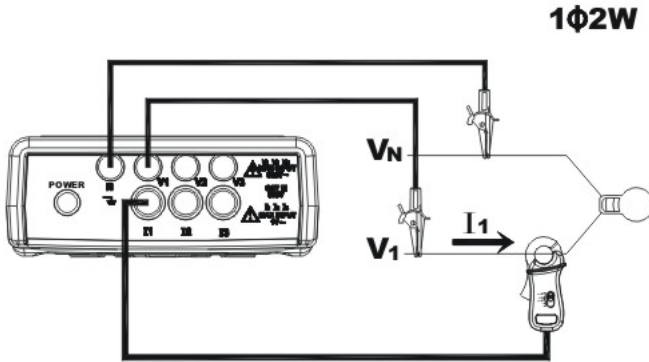

- Press **POWER** and then **1Φ3Φ** to select the 1P2W system. The type of system will be displayed at the bottom right of the LCD
- Connect the test leads to the voltage terminals L1 and V_N (Neutral) of the system.
- Connect one current probe to the power analyzer input terminal I1.
- Clamp on to the L1. Make sure the current flows from the front of the current probe to the back (see arrow labeled on clamp probe).
- All of the parameters of the system will be shown in the LCD
-



For a description of each parameter, refer to XIV. NOMENCLATURE.

Power Quality of a 1 Phase 3 Wire (1P3W) System

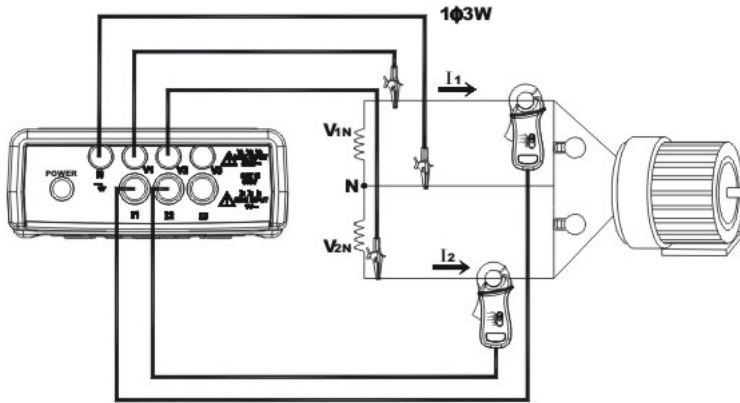

- Turn the power on. Press the **POWER** and the **1Φ3Φ** buttons to select the 1P3W system. The type of system will be displayed at the bottom right of the LCD.
- Connect the test leads to the voltage terminals L1, L2 and V_N (Neutral) of the system.
- Connect the two current probes to the power analyzer input terminal I1 and I2.
- Clamp on to the L1 and L2. Make sure the current flows from the front of the current probe to the back.
- All of the system parameters will be shown in the LCD

U1: 220.0 V	I1: 797.7mA	
U2: 220.0 V	I2: 800.7mA	
P1: 158.4 W	S1: 175.4 VA	Q1: -79.3 VAR
P2: 154.2 W	S2: 176.1 VA	Q2: -85.0 VAR
PΣ: 310.6 W	SΣ: 351.3 VA	QΣ: -164.3 VAR
PFΣ: 0.88 PF1: 0.89 PF2: 0.87		
PFH: 0.88 φ1: -27.1° φ2: -29.0°		
WH: 4.3 WH	SH: 4.8 VAH	QH: 2.2 VARH
HZ: 50.0 Hz	MD: VA	MD: W -15
1Φ3W	SEC: 2 CT: 1 UT: 1	

For a description of each parameter, refer to XIV. NOMENCLATURE.

Measurement of a System with CT or VT (PT)

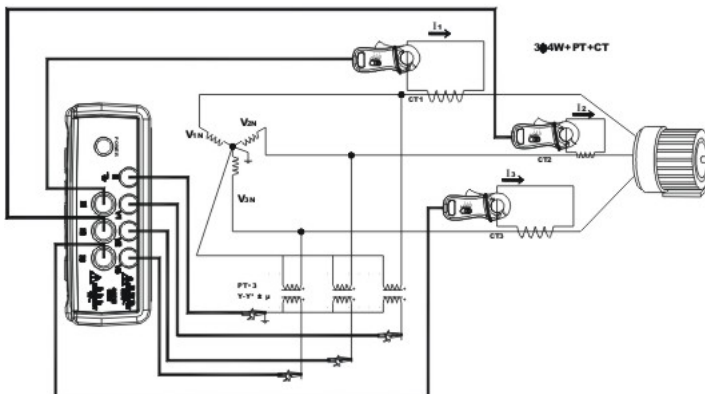

- Turn the power on. Press the POWER and the **1Φ3Φ** buttons to select the 3P4W system. The type of system will be displayed at the bottom right of the LCD.
- Connect the four test leads to the secondary voltage terminals L1, L2, L3 and the V_N (Neutral) of the system.
- Clamp on to the secondary coils of L1, L2, and L3. Make sure the current flows from the front of the current probe to the back (see the arrow label on the clamp probe).

```

Down Load File: 11:19
REC DATE: 5- 7-22 10:14:50
HZ: 50
VT: 1
CT 1
SEC: 2
CLAMP: 100
MD TIME: 15
TRANS REF: 110.0 V
SDUP: 5%

Year Month Date Hour Minute Second
2005 7 22 13 22 20
    
```

- Press **SETUP** to enter the SETUP menu.
- Press **SETUP** several times until the CT symbol is highlighted.
- Press the **▲** or **▼** button to increment or decrement the RATIO specified by the CT.

```

Down Load File: 1:19
REC DATE: 5- 7-22 10:14:50
HZ: 50
VT: 1
CT: 1
SEC: 2
CLAMP: 100
MD TIME: 15
TRANS REF:110.0 U
SDVP: 5%

Year Month Date Hour Minute Second
2005 7 22 13 22 9

```

- g. Press the **SETUP** button several times until the VT symbol is highlighted.
- h. Press the **▲** or **▼** button to increment or decrement the RATIO specified by the VT.
- i. All 35 system parameters will be shown in the LCD

For a description of each parameter, refer to XIV. NOMENCLATURE.

Harmonic Analysis of Voltage or Current

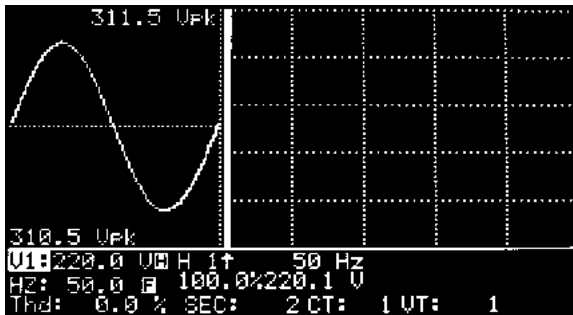

(Normal Voltage without Distortion and Harmonics)

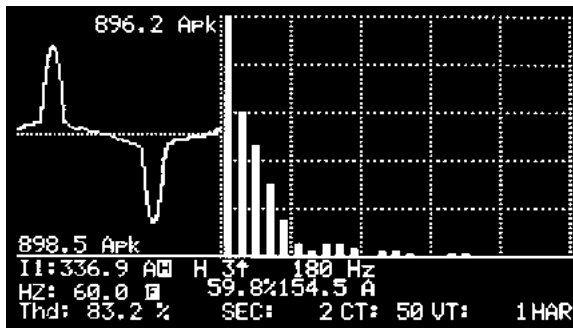

(Distorted Current with Harmonics)

- a. Setup the analyzer for measurement of any power system (3P4W, 3P3W, 1P2W, or 1P3W). To view the

harmonic analysis of voltage or current, press the **HARMO** button.

- b. Once the **HARMO** button is pressed, the waveform will be shown in the left-hand portion of the LCD, and the 1st to 50th order harmonics will be shown in the right-hand portion of the LCD.
- c. The positive and negative peak values will be shown in the waveform (Vpk).
- d. The true RMS value & total harmonic distortion of voltage or current is shown under the waveform.
- e. The cursor (↑ arrow) will point to the current order of harmonics. The frequency (HZ) will be displayed next to the cursor. The percentage of harmonics (%) will be displayed below the cursor. The magnitude of the harmonics (V or A) or phase angle will be displayed next to the %.
- f. Press the **SETUP** button several times until HAR is highlighted.
- g. To move the cursor to the next harmonic, use the ◀ or ▶ button.
- h. To see the next page (51st to 99th order) press the ▶ button to pass the 50th order or press the ◀ button to pass the 1st order.

NOTE: If the waveform is clipped at the peak or too small in the LCD, press the RANGE button to select HIGH or LOW range for a better display. The range indicator is the symbol after the unit of RMS value, L or H.

Display the Phase Angle of Harmonics

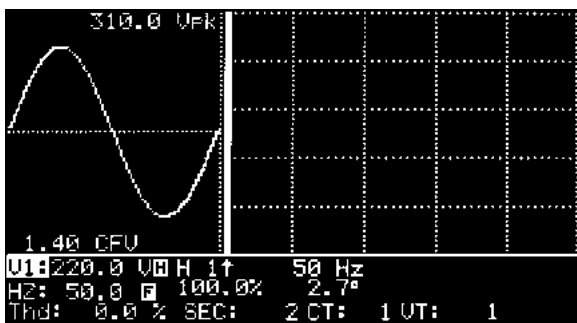

When the **HARMO** button is pressed the magnitude of each harmonic is displayed. To review the phase angle of each harmonic, press the PHASE button. The phase angle will be displayed next to the % **display icon**. V1 does not trigger at exactly 0 degrees; it may be a few degrees after '0'. The remaining signals (V2, V3, I1, I2, I3) are sampled when V1 is triggered. In other words, the phase angles for V2, V3, I1, I2, and I3 are sampled with respect to V1. For example, if V1, I1 have a phase difference of 30 degrees, they are displayed as V1 (2 degrees), I1 (32 degrees) in the harmonics analysis.

NOTE: If the waveform is clipped at the peak or too small in the LCD, press the RANGE button to select HIGH or LOW range for a better display. The range indicator is the symbol after the unit of RMS value, L or H.

Measurement of Maximum Demand

1. Set the time interval for maximum demand (refer to section V)
2. The analyzer will integrate the KW and KVA over the specified interval.
3. The maximum demand (MD) updates if new demand is greater than the previous value.

In the following example, the maximum demand is 527.4VA and 527.4W. The time interval for maximum demand is 2 minutes.

U1: 381.8 U	U1: 220.0 U	I1: 798.5mA
U2: 380.8 U	U2: 220.0 U	I2: 800.7mA
U3: 379.7 U	U3: 219.6 U	I3: 801.7mA
P1: 175.4 W	S1: 175.6 VA	Q1: 8.3 VAR
P2: 176.1 W	S2: 176.1 VA	Q2: 0.0 VAR
P3: 176.0 W	S3: 176.0 VA	Q3: 0.0 VAR
PΣ: 527.5 W	SΣ: 527.5 VA	QΣ: 8.3 VAR
PF0: 1.00	PF1: 0.99	PF2: 1.00
PF3: 1.00	PFH: 0.98	φ1: 2.9°
φ2: 1.0°	φ3: 0.8°	
MH: 60.7 WH	SH: 61.9 UAH	QH: 3.9 VARH
MD: 527.4 W	MD: 527.4 VA	MD: 527.4 W - 2
1#4U	SEC: 2 CT: 1	UT: 1

Waveform of Voltage and Current

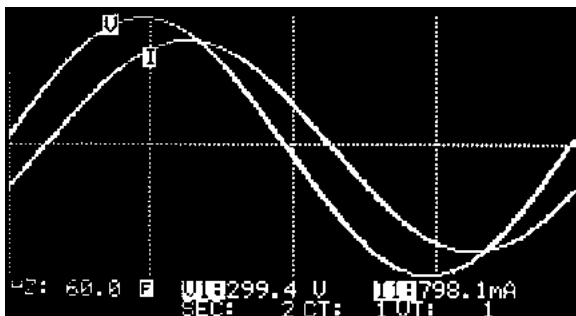

Press this button to display the waveforms for voltage and current simultaneously.

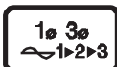

Press this to select different inputs (V1, I1), (V2, I2), or (V3, I3).

NOTE: The triggering point is the zero crossing point of V1 for V2, V3, I2, and I3. The triggering point for I1 is its own zero crossing point in case V1 is not present.

NOTE: In the waveform display mode, one period/cycle of 1024 data points is displayed.

Waveform for Voltage Only

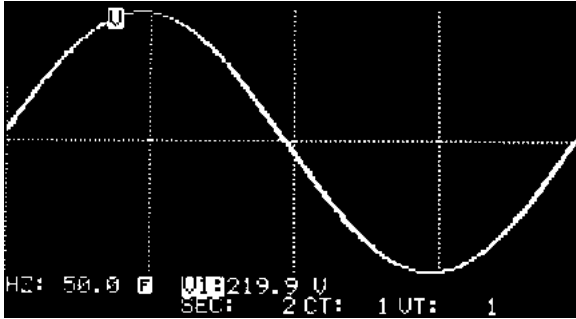

Press this button to display the voltage waveform only. The true RMS value of voltage will be displayed at the bottom of the LCD.



Press this button to select V1, V2, or V3.

NOTE: The triggering point is the zero crossing point of V1 for V2 and V3.

NOTE: In the waveform mode, one period/cycle of 1024 data points is displayed.

Graphic Phase Diagram

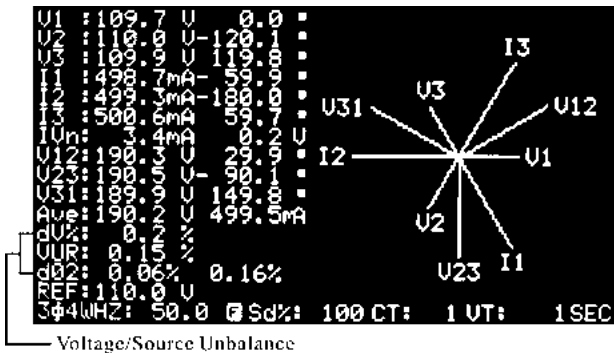

Press this button to display the phase diagram.

The voltage and current signals are displayed in phase format (magnitude, angle).

V1 is the reference. The V1 angle is always 0 degrees.

The phase angles of V2, V3, I1, I2, and I3 are displayed with respect to V1.

V1, V2, V3, I1, I2, I3, V12, V23, and V31 are displayed in vector form graphically.

V1, V2, V3: Phase voltages in phase format with respect to V1

I1, I2, I3: Line currents in phase format with respect to V1.

IVn: Calculated voltage and current of the neutral with respect to ground.

V12, V23, V31: Line voltage in phase format with respect to V1.

Ave: Average of line voltage V12, V23, and V31 and line current I1, I2, and I3

dV%: Historical maximum % value of $(\text{Max}(V1, V2, V3) - \text{Min}(V1, V2, V3)) / \text{Min}(V1, V2, V3) * 100\%$

VUR: Voltage (Unbalanced Ratio)

d02: The first number is Zero Sequence Unbalanced Ratio in % (d0) of voltage; the second number is the Negative Sequence Unbalanced Ratio in % (d2) of voltage. When VUR is displayed before d02, d02 represents the Zero and Negative Sequence Unbalanced Ratios for voltage.

REF: nominal voltage for transient detection reference

Sd%: threshold in % for transient detection with respect to nominal voltage (REF).

NOTE: The phase is drawn only when the reading exceeds 200 counts. If V is zero, the phase of the current will not be drawn.



Press this button to change the display from VUR to IUR

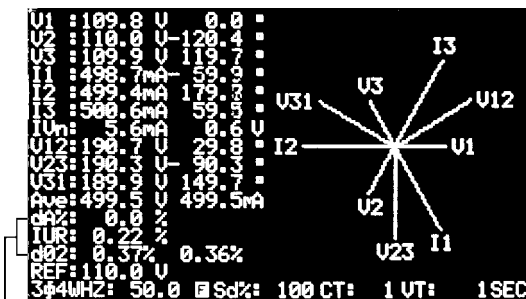

dA%: Historical max % value of $(\text{Max}(I1, I2, I3) - \text{Min}(I1, I2, I3)) / \text{Min}(I1, I2, I3) * 100\%$

IUR: Current Unbalance Ratio

d02: The first number is Zero Sequence Unbalanced Ratio in % (d0) for current; the second number is the Negative Sequence Unbalanced Ratio in % (d2) for current. When IUR is displayed before d02, d02 represents the Zero (d0) and Negative (d2) Sequence Unbalanced Ratios for current.

REF: Nominal voltage for transient detection reference

Sd%: Threshold in % for transient detection with respect to nominal voltage (REF).

NOTE: If the voltage of L1, L2, and L3 is not connected in the correct sequence, the analyzer will show L1-3-2 in the right top corner, and it will beep to warn of an incorrect phase sequence.

Phase Sequence of a 3 Phase System

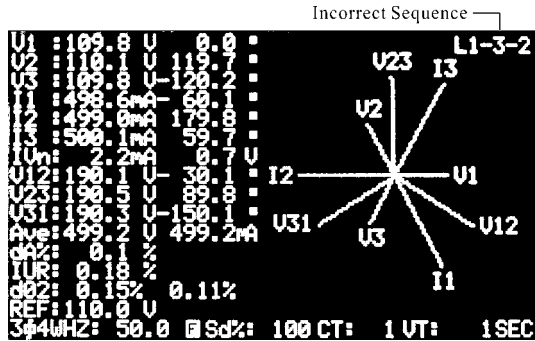

Press this button to display the phase diagram.

In this mode, the analyzer also detects the phase sequence. If the voltage of L1, L2, and L3 is not connected in the correct sequence, the analyzer will show L1-3-2 in the right top corner, and it will beep to warn of an incorrect phase sequence.

Balanced and Unbalanced 3 Phase (3P3W, 3P4W) Power Source System

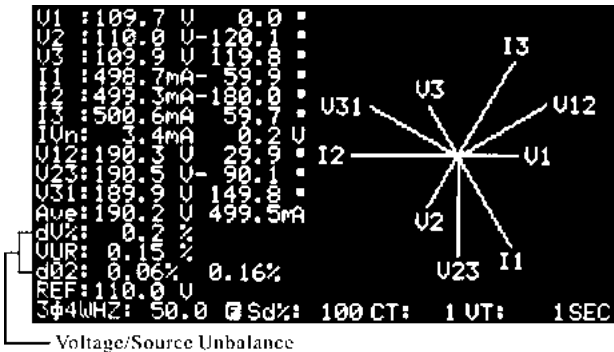

In order to check if a system is balanced, press this button to display the phase diagram along with the VUR.

Balanced System

If a 3 phase power source system is balanced, the parameters should be as follows:

$$V1 = V2 = V3$$

$$V12 = V23 = V31$$

The phase angle of V2 = -120; the phase angle of V3 = 120

Vn (voltage of neutral with respect to ground) = 0V

$$VUR = 0\%$$

$$d0\% = 0\%$$

d2% = 0%

Unbalanced Systems

If the values differ from the numbers above, an unbalanced power source system may be the reason. The magnitude of the differences can be used as an indication of an unbalanced power source system. The larger the difference, the further unbalanced the system will be.

Balanced and Unbalanced 3 Phase (3P3W or 3P4W) Load System

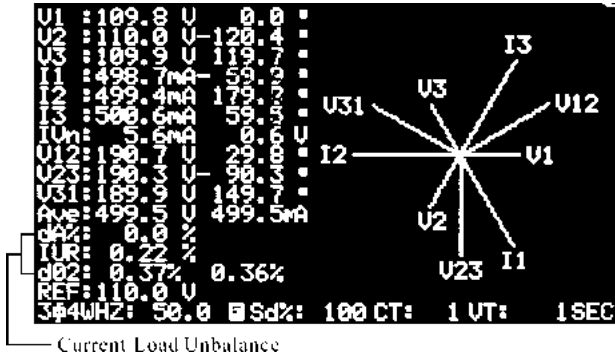

In order to check if current of a system is balanced, press the button twice to display the phase diagram with the IUR displayed.

Balanced System

If a 3 phase load system is balanced, the parameters should be as follows:

$$I1 = I2 = I3$$

$$\text{The phase angle for } I2 \text{ and } I1 (I2 \pm I1) = \pm 120$$

$$\text{The phase angles of } I3 \text{ and } I2 (I3 \pm I2) = \pm 120$$

$$I_n (\text{current of neutral}) = 0A$$

$$IUR = 0\%$$

$$d0\% = 0\%$$

$$d2\% = 0\%$$

Unbalanced Systems

If the values differ from the numbers above, an unbalanced load system may be the reason. The magnitude of the difference can be used as an indication of an unbalanced power source system. The larger the difference, the more unbalanced the load will be.

Transient Capture (Dips, Swells, Outage)

NO.	ELAPSED TIME (DAYS: HOURS: MINUTES)	CYCLES	TRANSIENT CODE
1	0d 2: 1	92	1 2d 9: 2
5	8d 12: 21	32	1 4 12d 8: 3
6	21d 6: 39	50	1 6 38d 6: 5
7	45d 12: 59	212	1 8 62d 10: 4

REF: 100.0 U
 34.4 HZ: 50.0 Sd%: 10 CT: 1 UT: 1 MD

NOMINAL VOLTAGE THRESHOLD (1-100%)



1. Press to enter the PHASE DIAGRAM mode.
2. Press the **SETUP** button until TRANS REF in reverse video is shown in the LCD.

```

Down Load File: 1:19
REC DATE: 5- 7-22 10:14:50
HZ: 50
UT: 1
CT: 1
SEC: 2
CLAMP: 100
MD TIME: 15
TRANS REF: 110.0 U
SDVP 5%

Year Month Date Hour Minute Second
2005 7 22 13 23 10
  
```

```

Down Load File: 1:19
REC DATE: 5- 7-22 10:14:50
HZ: 50
UT: 1
CT: 1
SEC: 2
CLAMP: 100
MD TIME: 15
TRANS REF 110.0 U
SDVP 5%

Year Month Date Hour Minute Second
2005 7 22 13 23 5
  
```

3. Press the ▲ or ▼ button to increment or decrement the nominal voltage for a reference. To exit, press the EXIT button.
4. Press the **SETUP** button several times until SDVP is shown in the right bottom corner of the LCD.
5. Press the ▲ or ▼ button to increment or decrement the threshold in % (SDVP). To exit, press the EXIT button.

6. Press the **TRANSIENT** button to start the "Transient Capture"
7. The backlight will switch off when the **TRANSIENT** button is pressed.
8. If the analyzer captures any transient events (DIP, SWELL, or OUTAGE), the backlight will switch on. Press the **TRANSIENT** button to review the recorded TRANSIENT events.
9. To exit TRANSIENT CAPTURE, press the **EXIT TRANSIENT** button.

Definition of SWELL, DIP, and OUTAGE:

SWELL: $V_{RMS} > [V_{REF} + (V_{REF} * SD\%)]$

Code for SWELL: 1

If the true RMS value of either phase (V1, V2, or V3) rises above the nominal value plus the threshold (REF + SD%), it is regarded as SWELL. Code for SWELL is 1.

DIP: $V_{RMS} < [V_{REF} - (V_{REF} * SD\%)]$

Code for DIP: 2

If the true RMS value of either phase (V1, V2, or V3) falls below the nominal value plus the threshold, it is regarded as DIP. The code for DIP is 2.

OUTAGE: $V_{RMS} < 30 \text{ to } 40V$

Code for OUTAGE: 4

If the true RMS value of either phase is less than 30 to 40V, it is regarded as OUTAGE. The code for OUTAGE is 4.

Code Table:

	SWELL	DIP	OUTAGE	COMMENT
CODE	1	2	4	Codes can be added together

DISPLAY FORMAT:

First column: Sequential number of events.

Second column: Elapsed time (the elapsed time format is DAYS, HOURS, MINUTES) 99 days 24 hours 60 minutes max

The third column: Number of cycles.

The fourth column: Code of transient events. There can be more than one transient condition occurring in one event.

NOTE: In the TRANSIENT CAPTURE mode, the analyzer takes 128 samples of each cycle for each phase continuously.

NOTE: When the user presses the TRANSIENT button to review the recorded events, the capture operation is paused until TRANSIENT is pressed again. The timer is also stopped when TRANSIENT is pressed. Therefore, the time stamp is not correct when the user presses the TRANSIENT button to resume operation.

NOTE: The analyzer can record up to 28 events. When the analyzer has recorded 28 events, it stops the capture operation, turns the backlight on, and displays the 28 transient events.

NOTE: The codes can be summed to indicate two or three conditions. For example, if the code is 6, DIP and OUTAGE (2+4) have been added.

NOTE: The longest duration for a capture operation is 99 days. Use the external 12V DC power adaptor for long capture operation.

WARNING: Select 50 or 60 Hz for transient capture. If AUTO is selected for frequency, the unit will not allow entrance to the TRANSIENT capture mode (an audible beep will sound).

Down Load Transient Data

When the TRANSIENT button is pressed to display CAPTURED EVENTS, the data is also output through the RS-232 interface simultaneously.

The data output is in the same format as the LCD display format (ASCII)

YEAR MONTH DAY HOUR MINUTE SECOND CT REF CODE

01 ELAPSED_TIME CYCLES CODE

02 ELAPSED_TIME CYCLES CODE

03 ELAPSED_TIME CYCLES CODE

04 ELAPSED_TIME CYCLES CODE

Datalogging Power Data (3P4W, 3P3W, 1P2W, 1P3W)

1. Set the datalogger sampling time (rate)
2. Press the **POWER** button to enter the power measurement mode.
3. Press the **1Φ3Φ** button to select the appropriate system (3P4W, 3P3W, 1P3W, or 1P2W).
4. Press the **REC** button to start logging. A **REC** symbol will display.
5. To stop logging, press the **REC** button again.

NOTE: To download data, send a CTRL+D command to the analyzer through RS-232C interface.
WARNING: The sampling time could be longer than the set value if there is no input at V1.

Down Load Power Data

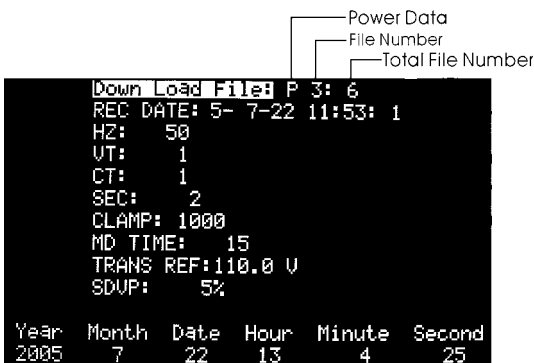

1. Press the **SETUP** button.
2. "Down Load File" will be shown in reverse video.
3. Press the **▲** or **▼** button to select the file number.
4. If the data stored in a selected file is power data, a leading symbol "P" will precede the file name
5. Press the EXIT button.
6. When a CTRL D command is received through the RS-232C port, it downloads stored power data.

NOTE: In the setup mode, the unit will not accept commands through the RS-232C port. To down load data, press the EXIT button to return to normal measurement mode.

Data Logging Harmonics Data

1. Set the sampling time (rate) for data logging
2. Press the **HARMO** button to enter the harmonics measurement mode.
3. Press the **V** button to select the desired input (V1, I1, V2, I2, V3, or I3).
4. Press the **REC** button to start data logging. A **REC** symbol will be displayed at the bottom of the LCD.

5. To stop data logging, press the **REC** button again.

WARNING: If there is no input at V1, the sampling rate could be longer than the programmed value.

Down Load Harmonics Data

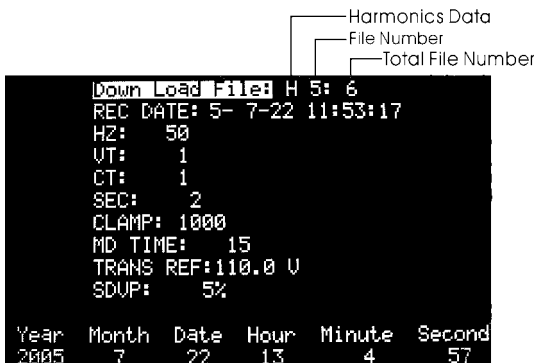

1. Press the **SETUP** button.
2. "Down Load File" will be shown in reverse video.
3. Press the **▲** or **▼** button to select the file number.
4. If the data stored in a selected file is harmonics data, a leading symbol "H" will precede the file name.
5. Press the EXIT button.
6. When the unit receives a CTRL D command through the RS-232C port, it will down load previously saved harmonic data.

NOTE: In the setup mode, the unit will not accept any commands through the RS-232C port. To down load data, press the EXIT button to return to normal measurement mode.



File Number

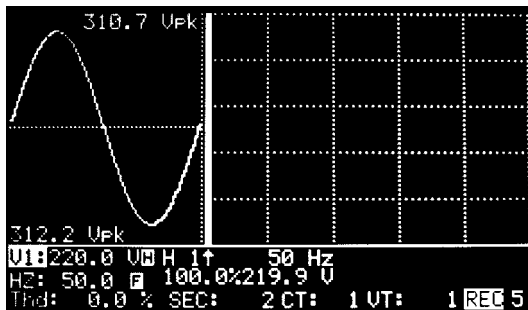

File Number

1. Press the **HOLD** button.
2. Press the **REC** button. It takes a few seconds to hardcopy the screen, and store the screen in an internal file. The LCD will show **REC** in reverse video when in operation. The number following REC is the file number.
3. Users can store up to 85 screens (if no power or harmonics data is stored).

READ the SAVED SCREEN



1. Press the **SETUP** button. 'DOWN LOAD FILE' is displayed in reverse video. If the data in the selected file is a hardcopy of the screen, a leading symbol of **H** is displayed in reverse video.
2. Press the **▲** or **▼** to select the saved screen.
3. Press the HOLD/READ button to restore the saved screen.

NOTE: If the data saved in a specific file is a HARDCOPY of a screen, a leading symbol of **H** is displayed in reverse video.

NOTE: Hardcopy data can not be downloaded.

SET THE CT AND VT (PT) RATIO

```
Down Load File: 1:19
REC DATE: 5- 7-22 10:14:50
HZ: 50
VT: 1
CT: 1
SEC: 2
CLAMP: 100
MD TIME: 15
TRANS REF:110.0 V
SDUP: 5%

Year Month Date Hour Minute Second
2005 7 22 13 22 20
```

```
Down Load File: 1:19
REC DATE: 5- 7-22 10:14:50
HZ: 50
VT: 1
CT: 1
SEC: 2
CLAMP: 100
MD TIME: 15
TRANS REF:110.0 V
SDUP: 5%

Year Month Date Hour Minute Second
2005 7 22 13 22 9
```

Press the **SETUP** button several times until CT or VT is shown in reverse video.

Press the ▲ or ▼ button to increment or decrement the value by 1. Holding the ▲ or ▼ button will speed up the process of incrementing or decrementing. To exit, press the EXIT button.

The CT ratio range is 1 to 600. The VT ratio range is 1 to 3000. Once the CT or VT (PT) is set, the voltage and current readings are as follows:

CURRENT (displayed) = CURRENT (measured) x CT Ratio

VOLTAGE (displayed) = VOLTAGE (measured) x VT Ratio

SET THE TIME INTERVAL FOR MAXIMUM DEMAND

```
Down Load File: 1:19
REC DATE: 5- 7-22 10:14:50
HZ: 50
VT: 1
CT: 1
SEC: 2
CLAMP: 100
MD TIME 15
TRANS REF:110.0 V
SDUP: 5%

Year  Month  Date  Hour  Minute  Second
2005   7     22   13    22     55
```

Press the **SETUP** button until MD TIME is displayed in reverse video.

Press the **▲** or **▼** button to increment or decrement the value by 1.

Holding the **▲** or **▼** button will speed up the process of incrementing or decrementing. To exit, press the EXIT button.

The MD (max. demand) time interval range is 1 to 60 minutes. Once the time interval is set, the unit will calculate the maximum demand and average demand in watts (W) or VA. To toggle between W and VA, press the **POWER** button.

SET THE SAMPLING TIME FOR DATA LOGGING

```
Down Load File: 1:19
REC DATE: 5- 7-22 10:14:50
HZ: 50
UT: 1
CT: 1
SEC: 2
CLAMP: 100
MD TIME: 15
TRANS REF:110.0 U
SDUP: 5%

Year  Month  Date  Hour  Minute  Second
2005   7     22   13    22     25
```

Press the **SETUP** button several times until SEC is displayed in reverse video.

Press the **▲** or **▼** button to increment or decrement the value by 2.

Holding the **▲** or **▼** button will speed up the process of incrementing or decrementing.

To exit, press the **EXIT** button.

SET THE CALENDER CLOCK

```
Down Load File: 1:19
REC DATE: 5- 7-22 10:14:50
HZ: 50
UT: 1
CT: 1
SEC: 2
CLAMP: 100
MD TIME: 15
TRANS REF:110.0 U
SDUP: 5%

Year  Month  Date  Hour  Minute  Second
2005   7     22   13    23     20
```

```
Down Load File: 1:19
REC DATE: 5- 7-22 10:14:50
HZ: 50
UT: 1
CT: 1
SEC: 2
CLAMP: 100
MD TIME: 15
TRANS REF:110.0 U
SDUP: 5%

Year  Month  Date  Hour  Minute  Second
2005   7     22   13    23     33
```

```
Down Load File: 1:19
REC DATE: 5- 7-22 10:14:50
HZ: 50
UT: 1
CT: 1
SEC: 2
CLAMP: 100
MD TIME: 15
TRANS REF:110.0 U
SDUP: 5%

Year  Month  Date  Hour  Minute  Second
2005   7     22   13    23     40
```

```
Down Load File: 1:19
REC DATE: 5- 7-22 10:14:50
HZ: 50
UT: 1
CT: 1
SEC: 2
CLAMP: 100
MD TIME: 15
TRANS REF:110.0 U
SDUP: 5%

Year  Month  Date  Hour  Minute  Second
2005   7     22   13    23     52
```

```
Down Load File: 1:19
REC DATE: 5- 7-22 10:14:50
HZ: 50
UT: 1
CT: 1
SEC: 2
CLAMP: 100
MD TIME: 15
TRANS REF:110.0 U
SDUP: 5%

Year  Month  Date  Hour  Minute  Second
2005   7     22   13    24     0
```

1. Press the SETUP button to select (Year, Month, Date, Hour, and Minute).
2. Press the ▲ or ▼ to increment or decrement the number.

Note: The 'seconds' field cannot be adjusted.

PROTOCOL (RS-232C INTERFACE)

RS-232C Interface:

Baud Rate 19200

Data bits 8

Stop bit 1

No Parity

SPECIFICATIONS (23°C ± 5°C)

AC Watts (50 or 60 Hz, PF 0.5 to 1. CT = 1, Voltage > AC 20V, Current > AC 4A for 100A range, Current > AC 40A for 1000A range and continuous waveform)

Model 382095 + 1000A clamp

Range (0 to 1000A)	Resolution	Accuracy of Readings ¹
5.0 – 999.9 W	0.1W	±1% ± 0.8W
1.000 – 9.999 KW	0.001 KW	±1% ± 8W
10.00 – 99.99 KW	0.01 KW	±1% ± 80W
100.0 – 999.9 KW	0.1 KW	±1% ± 0.8kW
1000 – 9999 KW	1 KW	±1% ± 8kW
0.000 – 9.999MW	0.001MW	±1% ± 80kW

AC Watt (50 or 60 Hz, PF 0.5 to 1. CT = 1, Voltage > AC 20V, Current > AC 40mA for 1A range, and Current > AC 0.4A for 10A range, Current > AC 04A for 100A range and continuous waveform)

Model 382095 + 100A clamp

Range (0 to 100A)	Resolution	Accuracy of Readings ²
5.0 – 999.9 W	0.1W	±1% ± 0.8W
1.000 – 9.999 KW	0.001 KW	±1% ± 8W
10.00 – 99.99 KW	0.01 KW	±1% ± 80W
100.0 – 999.9 KW	0.1 KW	±1% ± 0.8kW
1000 – 9999 KW	1 KW	±1% ± 8kW

^{1,2}For CT ≠ 1, the accuracy in percentage is the same (±1%). The additional digits should be multiplied by the CT ratio. For example, ±8dgts becomes ±8dgts * CT ratio

Range of CT (Current Transformer) Ratio: 1 to 600

Model 382095 + 3000A flexible clamp

Range (0 to 3000A)	Resolution	Accuracy of Readings ¹	
		>20V & >30A	<20V or <30A
10.0 – 999.9 W	0.1W	±1% of range	±2% of range
1.000 – 9.999 KW	0.001 KW	±1% of range	±2% of range
10.00 – 99.99 KW	0.01 KW	±1% of range	±2% of range
100.0 – 999.9 KW	0.1 KW	±1% of range	±2% of range
1000 – 9999 KW	1 KW	±1% of range	±2% of range

¹For VT ≠ 1, the accuracy in percentage is the same (±1%). The additional wattage should be multiplied by the VT ratio. For example, ±0.2W becomes ±0.2W * VT ratio

AC Apparent Power (VA, from 0.000VA to 9999 KVA)

$$VA = V \text{ r.m.s.} \times A \text{ r.m.s}$$

AC Reactive Power (VAR, from 0.000 VAR to 9999 KVAR)

$$VAR = \sqrt{(VA^2 - W^2)}$$

Range of VT (Voltage Transformer) Ratio: 1 to 3000

AC Active Energy (WH, or KWH, from 0 WH to 999,999 KWH)

$$WH = W * \text{Time (in hours)}$$

AC Current (50 or 60 Hz, Auto Range, True RMS, Crest Factor < 4, CT=1)

1000A Clamp (Overload Protection AC 2000A)

Range	Resolution	Accuracy of Readings ³
10.00A	0.001A/0.01A	—
100.0A	0.01A/0.1A	±0.5% ± 0.5A
40A to 1000.A	0.1A/1A	±0.5% ± 5A

100A Clamp (Overload Protection AC 200A)

Range	Resolution	Accuracy of Readings ⁴
0.04A to 1A	0.001 A	±0.5% ± 0.05A
0.4A to 10A	0.01 A	±0.5% ± 0.5A
4A to 100A	0.1 A	±1.0% ± 0.5A

^{3,4}For CT ≠1, the accuracy in percentage is the same (±0.5%). The additional digits should be multiplied by the CT ratio. For example, ±5 digits becomes ±5 digits * CT ratio

3000A Flexible Clamp

Range	Resolution	Accuracy of Readings ⁴
0 to 300.0 A	0.1 A	±1% of range
300.0 to 999.9 A	0.1 A	±1% of range
1000 to 3000 A	1 A	±1% of range

⁴For CT ≠1, the accuracy in percentage is the same (±1.0%).

AC Voltage (50 or 60 Hz, Auto Range, True RMS, Crest Factor < 4, Input Impedance 10 MΩ, VT (PT) = 1, Overload Protection AC 800V)

Range	Resolution	Accuracy of Readings ⁶
20.0 V to 500.0 V (Phase to Neutral)	0.1 V	±0.5% ± 5dgts
20.0 V to 600.0 V (Phase to Phase)	0.1 V	±0.5% ± 5dgts

⁶For VT (PT) ≠1, the accuracy in percentage is the same (±0.5%). The additional digits should be multiplied by the CT ratio. For example, ±5 digits becomes ±5 digits * VT (PT) ratio

Harmonics of AC Voltage in Percentage (1 to 99th order, minimum voltage at 50 or 60 Hz > AC 80V. If the voltage is 0 at 50 or 60 Hz, all the percentage displays will be 0.)

Range	Resolution	Accuracy
1 to 20 th	0.1%	±2%
20 to 49 th	0.1%	4% of reading ±2.0%
50 to 99 th	0.1%	6% of reading ±2.0%

Harmonics of AC Voltage in Magnitude (1 to 99th order, minimum voltage at the 50 or 60 Hz > AC 80V, VT=1)

Range	Resolution	Accuracy
1 to 20 th	0.1V	±2% ± 0.5V
20 to 49 th		4% of reading ±0.5V
50 to 99 th		6% of reading ±0.5V

Harmonics of AC Current in Percentage (1 to 99th order, minimum current at the 50 or 60 Hz > 20 A. If the current is 0 at 50 or 60 Hz, all the percentage (%) display is 0.)

1000A Clamp

Range	Resolution	Accuracy
1 to 20 th	0.1%	±2%
20 to 49 th	0.1%	4% of reading ±2.0%
50 to 99 th	0.1%	6% of reading ±2.0%

Harmonics of AC Current in Magnitude (1 to 99th order, minimum current at the 50 or 60 Hz > 20A, CT=1)

1000A Clamp

Range	Resolution	Accuracy
1 to 20 th	0.1A	±2% of reading ±0.4A
20 to 49 th		±4% of reading ±0.4A
50 to 99 th		±6% of reading ±0.4A

Harmonic of AC Current in Percentage (1 to 99th order, minimum current at the 50 or 60 Hz > 20 A. If the current is 0 at 50 or 60 Hz, all the percentage (%) display is 0.)

100A Clamp

Range	Resolution	Accuracy
1 to 10 th	0.1 %	±0.2% of reading ±1%
11 to 20 th	0.1 %	±2% of reading ±1%
21 to 50 th (A range)	0.1 %	±5% of reading ±1%
21 to 50 th (mA range)	0.1 %	±10% of reading ±1%
51 to 99 th	0.1 %	±35% of reading ±1%

Harmonics of AC Current in Magnitude (1 to 99th order, minimum current at the 50 or 60 Hz > 20A, CT=1)

100A Clamp

Range	Resolution	Accuracy
1 to 10 th	0.1mA / 0.1A	±0.2% of reading ±7dpts
11 to 20 th		±2% of reading ±7dpts
21 to 50 th (A range)		±5% of reading ±7dpts
21 to 50 th (mA range)		±10% of reading ±7dpts
51 to 99 th		±35% of reading ±7dpts

Harmonic of AC Current in Percentage (1 to 99th order, minimum current at 50 or 60 Hz is greater than 20A. If the current is 0 at 50 or 60 Hz, all the percentage (%) display is 0)

3000A Flexible Clamp

Range	Resolution	Accuracy
1 to 20 th	0.1 %	±2%
21 to 50 th	0.1 %	±6%
51 to 99 th	0.1 %	±10%

Harmonics of AC Current in Magnitude (1 to 99th order, minimum current at the 50 or 60 Hz > 20A, CT=1)

3000A Flexible Clamp

Range	Resolution	Accuracy
1 to 20 th	0.1A	±2% of range ±0.4A
21 to 50 th		±4% of range ±0.4A
51 to 99 th		±6% of range ±0.4A

Harmonics of AC Current in Magnitude (1 to 99th order, minimum current at 50 or 60 Hz is greater than 300A)

3000A Flexible Clamp

Range	Resolution	Accuracy
1 to 20 th	0.1A	±2% of range ±40A
21 to 50 th		±4% of range ±40A
51 to 99 th		±6% of range ±40A

Power Factor (PF)

Range	Resolution	Accuracy
0.00 to 1.00	0.01	± 0.04 (>20V and >30A)

Phase Angle (Φ)

Range	Resolution	Accuracy
-180° to 180°	0.1°	± 1°

Total Harmonic Distortion (THD-F with respect to the 50 or 60 Hz, min. value at the 50 or 60 Hz > 80V and > 20 A, 1 to 50th Harmonics. If the voltage or current is 0 at 50 or 60 Hz, all of the percentage (%) displays are 0)

1000A Clamp

Range	Resolution	Accuracy
0.0 to 20%	0.1%	± 2%
20 to 100%	01%	± 6% of reading ± 1%
100 to 999.9 %	0.1%	± 10% of reading ± 1%

Total Harmonic Distortion (THD-F with respect to the fundamental frequency, min. value at 50 or 60 Hz is greater than AC 80V, greater than 10% of the range. Calculation is done over 1 to 50th Harmonics. If the voltage or current is 0 at 50 or 60 Hz, all the percentage (%) displays are 0).

100A Clamp

Range	Resolution	Accuracy
0.0 to 20.0 %	0.1%	± 1%
20.0 to 100%	0.1%	±3% of reading ± 5%
100 to 999.9%	0.1%	±10% of reading ±10%

3000A Flexible Clamp

Range	Resolution	Accuracy
0.0 to 20%	0.1%	± 2% of range
20 to 100%	0.1%	±6% of range ± 1%
100 to 999.9%	0.1%	±10% of range ±1%

Peak Value of AC Voltage (peak value > 5V) or AC Current (peak value > 20A), VT=1

Model 382095 + 1000A Clamp

Range	Sampling Time	Accuracy of Reading
50 Hz	39 µs	± 5% ± 30 digits
60 Hz	33 µs	± 5% ± 30 digits

Peak Value of AC Voltage (peak value > 5V) or AC Current (peak value > 10% of the range), VT=1

Model 382095 + 100A Clamp

Range	Sampling Time	Accuracy of Reading
50 Hz	19µs	± 5% ± 30 digits
60 Hz	16µs	± 5% ± 30 digits

Peak Value of AC Voltage (peak value > 5V) or AC Current (peak value > 20A), VT=1

Model 382095 + 3000A Flexible Clamp

Range	Sampling Time	Accuracy of Reading
50 Hz	39 μ s	$\pm 5\% \pm 30$ digits
60 Hz	33 μ s	$\pm 5\% \pm 30$ digits

Crest Factor (C.F.) of ACV (peak value > 5V) or ACA (peak value > 20A), VT=1

Model 382095 + 1000A Clamp

Range	Resolution	Accuracy of Readings
1.00 to 99.99	0.01	$\pm 5\% \pm 30$ digits

Crest Factor (C.F.) of AC Voltage (peak value > 5V) or AC Current (peak value > 10% of the range), VT=1

Model 382095 + 100A Clamp

Range	Resolution	Accuracy of Readings
1.00 to 99.99	0.01	$\pm 5\% \pm 30$ digits

Crest Factor (C.F.) of AC Current (RMS value > 30A)

Model 382095 + 3000A Flexible Clamp

Range	Resolution	Accuracy of Readings
1.00 to 99.99	0.01	$\pm 5\% \pm 30$ digits

Frequency in AUTO mode

Range	Resolution	Accuracy of Reading
45 – 65 Hz	0.1Hz	0.1Hz 0.2Hz (3000A flex clamp)

Model 382095

For indoor use only

Battery Type:	Eight (8) 1.5V 'AA' batteries
Display:	Dot Matrix LCD (240x128) with backlight
LCD Update Rate:	once per second
Power Consumption:	140mA (approx.)
No. of Samples:	1024 samples / period
Data Logging Capacity:	17474 records (3P4W, 3P3W) 26210 records (1P3W) 52420 records (1P2W) 4096 records (50 Harmonics / record)
Sampling Time:	2 to 3000 seconds for data logging
Low battery Indication:	
Overload Indication:	OL
Dimensions:	257 (L) x 155 (W) x 57 (H) mm 10.1" (L) x 6.1" (W) x 2.3" (H)
Weight:	2.5 lbs. (1160g) Batteries included
Accessories:	Four (4) test leads 9.8' (3m) in length Alligator clips x 4 Carrying bag x 1 Users manual x 1 Batteries 'AA' 1.5V x 8

1000A Current Probe

Conductor Size:	2.2" (55mm), 2.5" x 1.0" (64 x 24mm) bus bar
Range Selection:	Manual (10A, 100A, 1000A)
Dimensions:	244mm (L) x 97mm (W) x 46mm (H) 9.6" (L) x 3.8" (W) x 1.8" (H)
Weight:	1.3 lbs. (600g)
Operating Temperature:	14 to 122°F (-10°C to 50°C)
Operating Humidity:	< 85% relative humidity
Altitude:	< 2000 meters
Storage Temperature:	-4 to 140°F (-20°C to 60°C)
Storage Humidity:	< 75% relative

100A Current Probe

Conductor Size:	1.2" (30mm) approx.
Range Selection:	Manual (1A, 10A, 100A)
Dimensions:	210mm (L) x 62mm (W) x 36mm (H) 8.3" (L) x 2.5" (W) x 1.4" (H)
Weight:	7 oz. (200g)
Operating Temperature:	14 to 122°F (-10°C to 50°C)
Operating Humidity:	< 85% relative humidity
Altitude:	< 2000 meters
Storage Temperature:	-4 to 140°F (-20°C to 60°C)
Storage Humidity:	< 75% relative

3000A Flexible Current Probe

Probe Length:	24" (610mm)
Range Selection:	Manual (300A, 3000A)
Minimum Bending Diameter	1.37" (35mm)
Connector Diameter	0.9" (23mm)
Cable Diameter	0.55" (14mm)
Cable Length	6.7"/170mm (probe to box) 6.7"/170mm (box to output)
Dimensions (box):	5.1" (L) x 3.1" (W) x 1.7" (H) 130mm (L) x 80mm (W) x 43mm (H)
Weight:	14.4 oz. (410g)
Operating Temperature:	14 to 185°F (-10°C to 85°C)
Operating Humidity:	< 85% relative humidity
Altitude:	< 2000 meters
Storage Temperature:	-4 to 185°F (-20°C to 85°C)
Storage Humidity:	< 85% relative

BATTERY REPLACEMENT

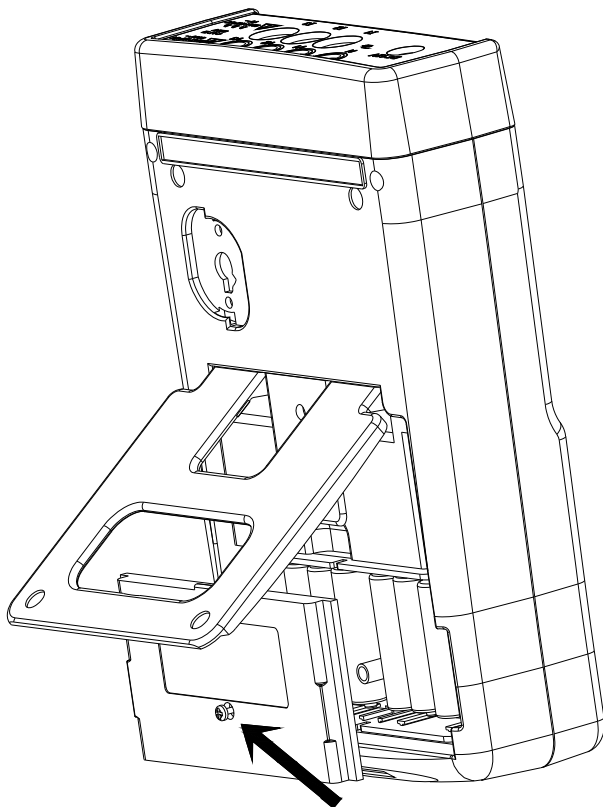

When the low battery symbol is displayed on the LCD, replace the batteries.

1. Turn power off and remove all of the test leads and current probes from the unit.
2. Remove the screw on the battery cover.
3. Lift and remove the battery cover.
4. Remove the old batteries.
5. Insert eight (8) new 1.5V 'AA' batteries.
6. Replace the battery cover and secure the screw.

MAINTENANCE & CLEANING

Service not covered in this manual should only be performed by qualified personnel. Repairs should only be performed by qualified personnel. Periodically wipe the case with a damp cloth and detergent; do not use abrasives or solvents.

NOMENCLATURE

V12, V23, V31: Line Voltage
V1, V2, V3: Phase Voltage
I1, I2, I3: Line Current
P1, P2, P3: True Power (W) of Each Phase
S1, S2, S3: Apparent (VA) Power of Each Phase
Q1, Q2, Q3: Reactive Power (VAR) of Each Phase
PΣ: Total System Power (W)
SΣ: Total System Apparent Power (VA)
QΣ: Total Reactive Power (VAR)
PFΣ: Total System Power Factor (PF)
PF1, PF2, PF3: Power Factor of Each Phase
PFH: Long Term Average Power Factor (WH / SH)
Φ1, Φ2, Φ3: Phase Angle of Each Phase
WH: Watt Hours
SH: VA hours
QH: VAR hours
HZ: Selected Frequency 50, 60 or Auto.
MD: Maximum Demand in W and VA over Specified Interval
3P4W: 3 Phase 4 Wire System
3P3W: 3 Phase 3 Wire System
1P2W: Single Phase 2 Wire System
1P3W: Single Phase 3 Wire System
SEC: sampling interval (0 to 3000 seconds) for data logging
CT: Current Transformer Ratio from 1 to 600
VT: Voltage Transformer Ratio from 1 to 3000

Warranty

*FLIR Systems, Inc. warrants this Extech Instruments brand device to be free of defects in parts and workmanship for **one year** from date of shipment (a six month limited warranty applies to sensors and cables). If it should become necessary to return the instrument for service during or beyond the warranty period, contact the Customer Service Department for authorization. Visit the website www.extech.com for contact information. A Return Authorization (RA) number must be issued before any product is returned. The sender is responsible for shipping charges, freight, insurance and proper packaging to prevent damage in transit. This warranty does not apply to defects resulting from action of the user such as misuse, improper wiring, operation outside of specification, improper maintenance or repair, or unauthorized modification. FLIR Systems, Inc. specifically disclaims any implied warranties or merchantability or fitness for a specific purpose and will not be liable for any direct, indirect, incidental or consequential damages. FLIR's total liability is limited to repair or replacement of the product. The warranty set forth above is inclusive and no other warranty, whether written or oral, is expressed or implied.*

Calibration, Repair, and Customer Care Services

FLIR Systems, Inc. offers repair and calibration services for the Extech Instruments products we sell. NIST certification for most products is also provided. Call the Customer Service Department for information on calibration services available for this product. Annual calibrations should be performed to verify meter performance and accuracy. Technical support and general customer service is also provided, refer to the contact information provided below.

Support Lines: U.S. (877) 439-8324; International: +1 (603) 324-7800

Technical Support: Option 3; E-mail: support@extech.com

Repair & Returns: Option 4; E-mail: repair@extech.com

Product specifications are subject to change without notice

Please visit our website for the most up-to-date information

www.extech.com

FLIR Commercial Systems, Inc., 9 Townsend West, Nashua, NH 03063 USA

Copyright © 2013 FLIR Systems, Inc.

All rights reserved including the right of reproduction in whole or in part in any form

www.extech.com

Garantie

FLIR Systems, Inc. garantit que cet appareil Extech Instruments est exempt de défauts matériaux et de fabrication pendant un an à partir de la date d'envoi (une garantie limitée de six mois s'applique aux capteurs et aux câbles). Si le renvoi de l'appareil pour réparation devient nécessaire durant ou après la période de garantie, contactez le service client pour autorisation. Pour obtenir les coordonnées, visitez le site Web suivant : www.extech.com. Un numéro d'autorisation de retour (AR) doit être délivré avant tout retour de produit. L'expéditeur prend à sa charge les frais d'expédition, le fret, l'assurance et l'emballage correct de l'appareil afin de prévenir toute détérioration durant le transport. Cette garantie ne s'applique pas aux dommages imputables à l'utilisateur, tels que l'usage impropre ou abusif, un mauvais câblage, une utilisation non conforme aux spécifications, un entretien ou une réparation incorrecte, ou toute modification non autorisée. FLIR Systems, Inc. déclinera spécifiquement toute garantie ou qualité marchande ou aptitude à l'emploi prévu, et ne sera en aucun cas tenu responsable pour tout dommage conséquent, direct, indirect ou accidentel. La responsabilité totale de FLIR est limitée à la réparation ou au remplacement du produit. La garantie définie ci-dessus est inclusive et aucune autre garantie, écrite ou orale, n'est exprimée ou implicite.

Calibrage, réparation et services après-vente

FLIR Systems, Inc. offre des services de calibrage et de réparation pour les produits Extech Instruments que nous commercialisons. Nous fournissons également une certification NIST pour la plupart des produits. Contactez notre service client pour toute information sur les services de calibrage disponibles pour ce produit. Un calibrage doit être effectué chaque année pour vérifier les performances et la précision du mètre. Nous offrons également une assistance technique et un service à la clientèle. Veuillez vous reporter aux coordonnées fournies ci-dessous.

Lignes d'assistance: États-Unis (877) 439-8324; international: +1 (603) 324-7800

Service d'assistance technique : Option 3 ; E-mail : support@extech.com

Réparations et retours : Option 4 ; E-mail : repair@extech.com

Les spécifications produit sont sujettes à modifications sans préavis.

Pour les toutes dernières informations, veuillez visiter notre site Web.

www.extech.com

FLIR Commercial Systems, Inc., 9 Townsend West, Nashua, NH 03063 USA

Copyright © 2013 FLIR Systems, Inc.

Tous droits réservés, y compris la reproduction partielle ou totale sous quelque forme que ce soit.

www.extech.com

Garantía

FLIR Systems, Inc., garantiza este dispositivo marca Extech Instruments para estar libre de defectos en partes o mano de obra durante un año a partir de la fecha de embarque (se aplica una garantía limitada de seis meses para cables y sensores). Si fuera necesario regresar el instrumento para servicio durante o después del periodo de garantía, llame al Departamento de Servicio a Clientes para obtener autorización. Visite www.extech.com para Información de contacto. Se debe expedir un número de Autorización de Devolución (AD) antes de regresar cualquier producto. El remitente es responsable de los gastos de embarque, flete, seguro y empaque apropiado para prevenir daños en tránsito. Esta garantía no se aplica a defectos resultantes de las acciones del usuario como el mal uso, alambrado equivocado, operación fuera de las especificaciones, mantenimiento o reparación inadecuada o modificación no autorizada. FLIR Systems, Inc., rechaza específicamente cualesquier garantías implícitas o factibilidad de comercialización o idoneidad para cualquier propósito determinado y no será responsable por cualesquier daños directos, indirectos, incidentales o consecuentes. La responsabilidad total de FLIR está limitada a la reparación o reemplazo del producto. La garantía precedente es inclusiva y no hay otra garantía ya sea escrita u oral, expresa o implícita.

Servicios de calibración, reparación y atención a clientes

FLIR Systems, Inc., ofrece servicios de reparación y calibración para los productos que vendemos de Extech Instruments. Además ofrecemos certificación NIST para la mayoría de los productos. Llame al Departamento de Servicio al Cliente para solicitar información de calibración para este producto. Para verificar el funcionamiento y precisión se debe realizar la calibración anual. Además se provee Soporte Técnico y servicios generales al cliente, consulte la información de contacto en seguida.

Líneas de soporte: EE.UU. (877) 439-8324; Internacional: +1 (603) 324-7800

Soporte Técnico Opción 3; correo electrónico: support@extech.com

Reparación / Devoluciones: Opción 4; correo electrónico: repair@extech.com

Las especificaciones del producto están sujetas a cambios sin aviso

Por favor visite nuestra página en Internet para la información más actualizada

www.extech.com

FLIR Commercial Systems, Inc., 9 Townsend West, Nashua, NH 03063 USA

Copyright © 2013 FLIR Systems, Inc.

Reservados todos los derechos, incluyendo el derecho de reproducción total o parcial en cualquier medio

www.extech.com