

MICRODUST pro
Aerosol Monitoring System
WINDUST pro
Application Software
Users Handbook

HB3275-06

COPYRIGHT

The copyright in this document which contains proprietary information is vested in CASELLA CEL. The contents of this document must not be used for purposes other than that for which it has been supplied or reproduced or disclosed wholly or in part without the prior written permission of

CASELLA CEL.

CASELLA CEL
Regent House
Wolseley Road
Kempston
Bedford
MK42 7JY United Kingdom
Phone: +44 (0) 1234 844 100
Fax: +44 (0) 1234 841 490
E-mail: info@casellacel.com
Web: www.casellacel.com

CASELLA USA
17 Old Nashua Road #15
Amherst
NH 03031
U.S.A.
Toll Free: +1 800 366 2966
Fax: +1 603 672 8053
E-mail: info@casellausa.com
Web: www.casellausa.com

New with Firmware Version 06

Many customers who use the Microdust Pro in monitoring situations require a voltage output that can be connected to external logging devices such as chart recorders, or to control systems. Firmware version 06 provides this facility.

The user can select an analogue output level from either a direct voltage output, or from an average value. The output level can be set to trigger an audible internal alarm when the output exceeds a pre set level.

WARNINGS !

UNDER NO CIRCUMSTANCES should this instrument be cleaned using a solvent based cleaner.

Attempts to charge non-rechargeable cells is hazardous and can result in damage.

This instrument incorporates an internal fast-charger circuit suitable for recharging nickel-cadmium cells. The charger is enabled/disabled via a switch in the battery compartment, see Figure 11.

This instrument is delivered with re-chargeable nickel-cadmium cells and with the CHARGER circuit ENABLED.

DISABLE the charger circuit before fitting and using non-rechargeable cells.

DISPOSAL OF NiCd BATTERIES:

Rechargeable batteries contain CADMIUM and must be disposed of in a safe manner. In some countries, this may involve specialist licensed waste disposal companies.

Used batteries MUST NEVER be disposed of by placing in a fire or incinerator, nor must they be punctured, crushed or otherwise mutilated or opened up in anyway.

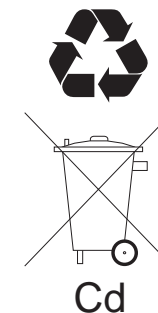

MICRODUST pro instruments contain no user serviceable components. If an electrical fault is suspected the instrument must be returned to Casella CEL Ltd for repair.

The probe contains delicate optical and electronic components. It should not be dropped or subjected to mechanical shock. Failure to comply will render the warranty invalid.

The warranty DOES NOT extend to cleaning or general servicing of the instrument.

GETTING STARTED

It is suggested that you prepare, calibrate and operate your MicroDust *pro* following the sequence of sections in the Operations Chapter:

Preparation,

Routine Calibration,

User Defined Calibration,

Measurement,

Logging.

For optimum accuracy, it is recommended that you perform a user calibration to correct your instrument for the type of dust to be measured.

TABLE OF CONTENTS

1.	DESCRIPTION OF THE MICRODUST <i>pro</i>	7
1.1	Introduction	7
1.2	Principle of Operation	8
1.3	The MicroDust <i>pro</i> Menu Structure	9
1.4	Analogue Output/RS 232 Socket	11
1.5	Schedule of Parts	12
2.	OPERATION	13
2.1	Preparation for Use	13
2.1.1	Power Supply	13
2.1.2	Sampling Probe	14
2.1.3	Supporting the Instrument	14
2.2	Preliminary Operations	15
2.2.1	Switching ON and OFF	15
2.2.2	Checking Battery Status & Firmware Version	16
2.2.3	Configuring for the Current Measurement	16
2.3	Calibration	21
2.3.1	Checking Zero and Span	21
2.3.2	Calibrating for a Specific Dust Type	23
2.3.3	Applying the Calibration	25
2.4	Measurement	26
2.4.1	Maximum Value (Max)	26
2.4.2	Time Weighted Average Value (Ave)	27
2.5	Data Logging	27
2.5.1	Configuring the Logger	27
2.5.2	Clearing the Logger Memory	28
2.5.3	Start Logging	28
3.	WINDUST <i>pro</i> APPLICATION SOFTWARE	31
3.1	Installation on Windows™ 95 & Windows NT	31
3.2	Starting WinDust <i>pro</i>	31
3.3	Profiles	32
3.3.1	Creating/Editing a Profile	32
3.3.2	Sending a Profile to the Instrument	34
3.4	Downloading Data from the Logger	35
3.5	Presentation of Data	35
3.5.1	Displaying the Data Summary	35
3.5.2	Displaying Data as a Graph	37

TABLE OF CONTENTS (Continued)

3.5.3	Displaying Data as a Table	38
3.5.4	Exporting Data to Other Applications	38
3.6	Real-Time Display Mode	39
3.7	Gravimetric Correction by WinDust <i>pro</i> Software	40
4.	SAMPLING ACCESSORIES	43
4.1	Gravimetric Adapters	43
4.2	T.S.P / Respirable Adapters	44
4.3	PUF Filter Adapter	45
4.4	Aspirator Unit	46
5.	MAINTENANCE & SERVICING	49
5.1	Service Department	49
5.2	Lens Contamination	49
5.2.1	Long Term Monitoring	49
5.2.2	Cleaning	50
5.3	Fault Finding Tips	50
6.	SPECIFICATION	51
6.1	Instrument Specification	51
6.2	Maintenance	53
6.3	WinDust <i>pro</i> , PC Based Application Software	53
6.4	Spare Parts	53
6.5	Optional Accessories	53
6.6	CE Compliance	53
Appendix A	57
Microdust <i>pro</i> Menu Structure	61

1. DESCRIPTION OF THE MICRODUST pro

1.1 Introduction

Airborne particulate matter can be found in the atmosphere in the form of dust, smoke, fumes, pollen, and other aerosols. Major sources of particulate in the urban and working environments include combustion, materials processing, manufacturing, energy generation, vehicle engine emissions, and construction.

Particulate matter is responsible for reduced visibility, the spread of contamination, inhalation of toxic substances and low worker productivity. It is also recognised as a contributory factor to many medical conditions including asthma, bronchitis and lung cancer.



Figure 1: The MicroDust pro

Traditional gravimetric methods of dust measurement require a significant sampling period and are not suited to the evaluation of concentration trends in real-time. The MicroDust pro is an ideal survey instrument for the assessment of real-time particulate concentration in mg/m^3 . It is totally portable and suitable for both fixed site and general survey applications. From firmware Version 06, a user selectable analogue output and alarm are provided that can be connected to external logging devices.

Accurate and repeatable dust concentration measurement is achieved using proven forward light scattering techniques. The MicroDust pro offers graphical presentation of concentration trends, internal data logging as standard, simple and clear user interface and digital calibration methods to suit any dust sampling scenario.

The WinDust pro WindowsTM software package supplied with this instrument has been developed to make the downloading and presentation of data as simple as possible. In addition, it offers a PC real time display of particle concentration with a scrolling graph.

The MicroDust *pro* is able to exhibit the highest degree of sensitivity for particle sizes within the respirable domain, while the detachable probe allows readings to be taken in relatively inaccessible areas.

The MicroDust *pro* offers measurement over four ranges:

- ✕ 0.001 to 2.500 mg/m³
- ✕ 0.01 to 25.00 mg/m³
- ✕ 0.1 to 250.0 mg/m³
- ✕ 1 to 2500 mg/m³

All instruments are calibrated at the factory using reference test dust (ISO Fine 12103-1 A2, equivalent to Arizona Road Dust). These facilities allow the calibration concentration to be determined using traceable gravimetric analytical techniques. An optical calibration element is supplied as a reference to confirm the factory calibration point. For optimum calibration against local dust conditions, a sampling pump and optional gravimetric or respirable adapter unit may be used to provide comparative analysis between gravimetric and real time data.

The high definition liquid crystal display is capable of showing both text and graphical information. It shows instrument configuration details, contaminant levels, logger information and battery condition.

1.2 Principle of Operation

The instrument uses a modulated beam of infra-red light projected forward into a measurement chamber.

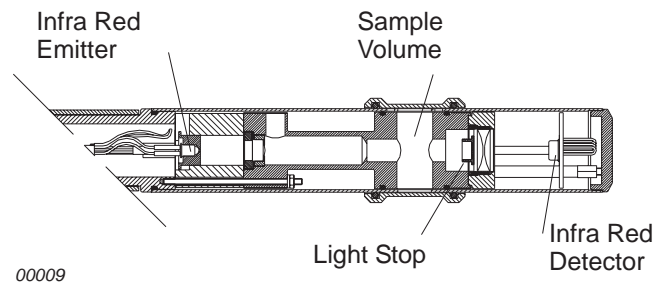

Figure 2: The sampling probe

Under clean air conditions all light is prevented from reaching the receiver by a light stop. When dust particles enter the sample volume, the light beam is scattered forward within a narrow (12 - 20°) angle to the receiver.

By using this narrow angle of scatter, the instrument's sensitivity to variations in the refractive index and colour of measured particulate is reduced.

Excellent linearity is achieved right up to 2500 mg/m³ as shown in Figure 3.

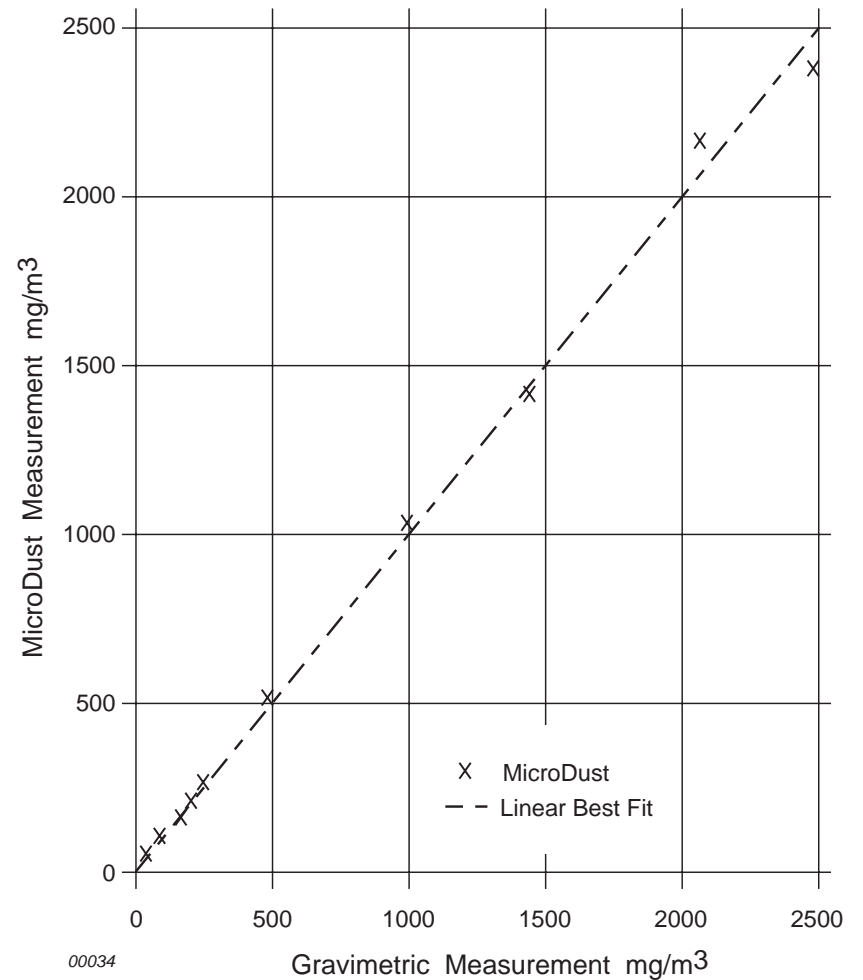

Figure 3: Instrument Response with ISO Fine 12103-1 A2
(Equivalent to Arizona Road Dust)

1.3 The MicroDust pro Menu Structure

The general instrument layout is shown in Figure 4.

The operator interface is based upon a series of menu options organised as shown on the fold out sheet at the back of this book.

A combination of function keys and navigator keys on the front panel of the instrument are used to move around the menu system and change setup parameters.

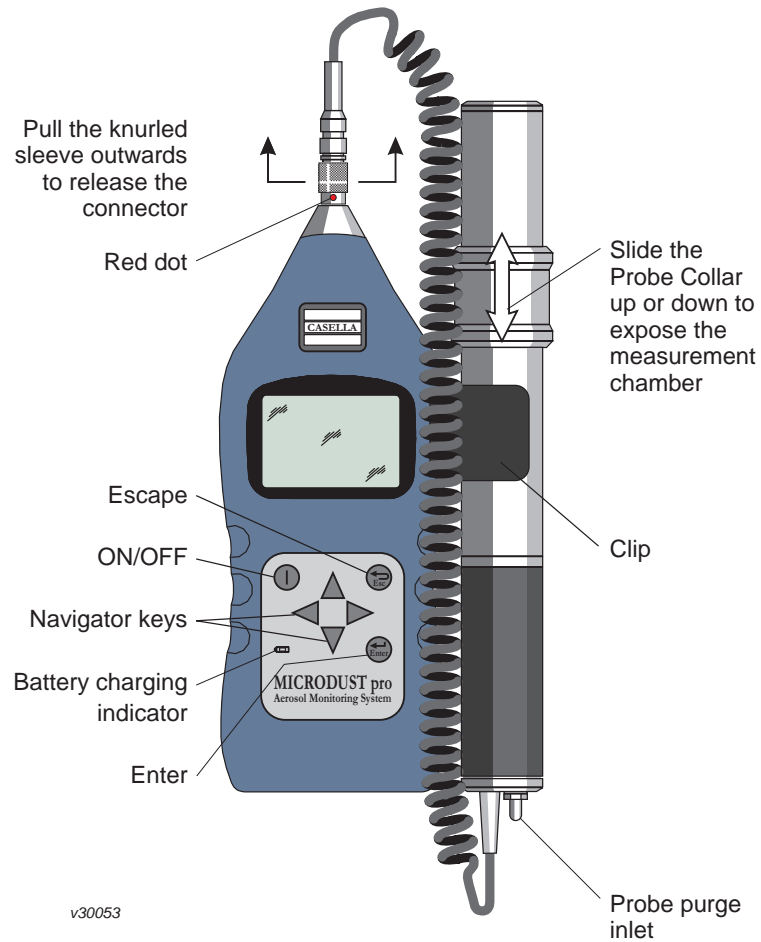

Figure 4: General layout of the MicroDust pro

The key functions are as follows.



Navigator keys used to move around the current menu options.



Navigator keys used to change the contents of the selected field, such as the indicated date, time, logging interval, etc.



Enter key that accepts the current menu option or highlighted option.



Esc (Escape) key that steps back to a previous menu.

Options that are not currently available are marked "X"; for example while the instrument is logging data, calibration cannot be performed.

Pressing  several times at any point provides a short cut back to the Main menu.

The Main menu contains all parameters and options relevant to operation and gives access to three sub-menus.

Calibration menu	Allows the instrument to be calibrated.
Configuration menu	Allows the instrument parameters to be specified.
Logger	Allows the logger to be configured and data storage to be started and stopped.

1.4 Analogue Output/RS 232 Socket

An analogue output signal is available for interfacing the MicroDust pro to a chart recorder or external data logger. Wiring details of the analogue output/RS 232 socket are shown in Figure 5 and Table 1.

From firmware Version 06, the user can select the output to represent either average or raw data sources, or set a high or low alarm condition.

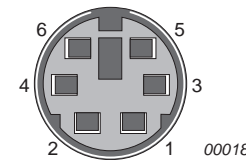

Figure 5:
Line identities of the Analogue/RS 232 socket, viewed externally (i.e. also from the solder bucket side of the plug)

Table 1: Line functions

Function	Pin Number	Wire Colour	9-way D Type (PC RS 232)
Analogue ground	1	Yellow	N/A
Analogue Out	2	Red	N/A
RS 232 Receive in	3	White	3 (TX out)
RS 232 Transmit out	4	Black	2 (RX in)
Comms ground	5	Blue	5 (Ground)
			4 (DTR), 8 (CTS), 6 (DSR) Linked together

Description

MICRODUST pro Aerosol Monitoring System &
WINDUST pro Application Software - Handbook

The analogue output signal has a full scale range of 0 - 2.5 volts and an output impedance of approximately 500 Ω .

The full scale output voltage is proportional to the full scale indication of the active range. For example, if the active range is 0 - 25 mg/m³, an output signal of 2.5 volts will represent a dust concentration of 25 mg/m³, (i.e. 1 mV per 0.01 mg/ m³).

The analogue output is available only when a fixed measurement range is selected (i.e. not Auto Range).

1.5 Schedule of Parts

MicroDust pro Control unit
MicroDust pro Probe
Calibration Filter
Carry Case
RS 232 Lead and Software
User Manual
4 x NiCad Rechargeable Batteries
12 V Power Supply with:
Mains Plug - UK Fitting
Mains Plug - European Fitting
Mains Plug - USA Fitting,
Mains Plug - Australian Fitting.

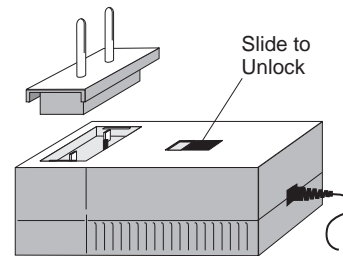

02055

Figure 6: Fitting plug adaptor

Figure 6 shows how the relevant plug adaptor for different local areas is fitted to the power supply unit.

Figure 7 shows the components of the kit installed in the carry case.

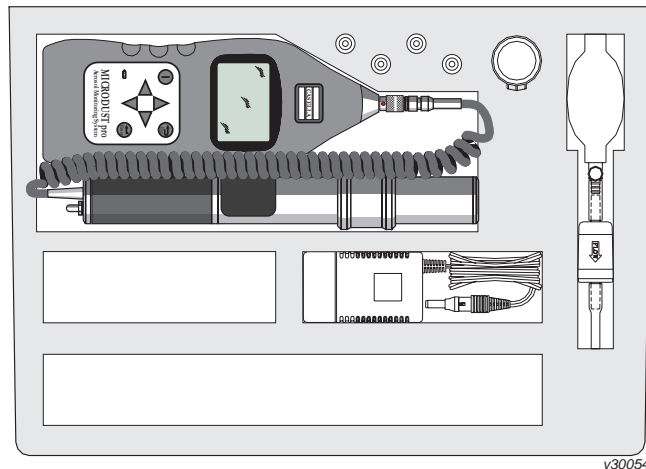

v30054

Figure 7: The MicroDust pro installed in the carry case

2. OPERATION

The MicroDust *pro* is a sensitive scientific instrument which should not be exposed to excessive moisture, vibration, or physical shocks.

The following steps must be performed before your MicroDust *pro* can be used under operating conditions. It is suggested that you follow the sequence of sections in this chapter.

For optimum accuracy, it is recommended that you always perform a user calibration to correct your instrument for the type of dust to be measured.

2.1 Preparation for Use

2.1.1 Power Supply

The MicroDust *pro* is powered by four AA size batteries located in a compartment in the underside of the instrument.

The instrument can also be powered continuously using external power applied via the 12 V DC socket (Figure 8), without the need for internal batteries to be installed.

To gain access to the batteries, lift the bottom end of the cover slightly to release it, then slide downwards in the direction of the arrow mark (Figure 9).

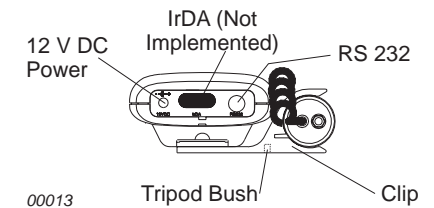

Figure 8: Bottom panel connectors

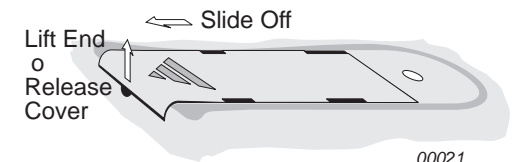

Figure 9: Removing battery cover

Warning !

One cell installed with the wrong polarity may still allow operation, but can cause overheating severe enough to rupture a cell and damage the instrument.

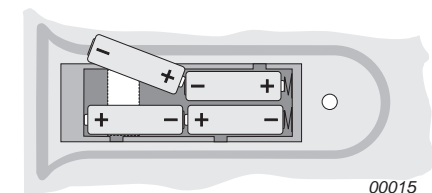

Figure 10: Loading batteries

Load four new batteries (AA or equivalent) in the orientations shown in Figure 10. Rechargeable nickel-cadmium (NiCd) 1.2 V batteries are recommended. 1.5 volt alkaline and other non-rechargeable batteries can also be used.

Rechargeable batteries may be supplied by Casella CEL in a discharged state. In order to obtain maximum capacity from new NiCd batteries, several charge and discharge cycles may be required.

Warning !

DO NOT enable the charger circuit while non-rechargeable batteries are installed.

The instrument has a built in fast-charging circuit that uses power applied via the 12 V DC socket shown in Figure 8. This allows rechargeable batteries to be recharged in-situ. When rechargeable batteries are to be charged in situ, set the Charger Enable DIP switch to ON as shown in Figure 11.

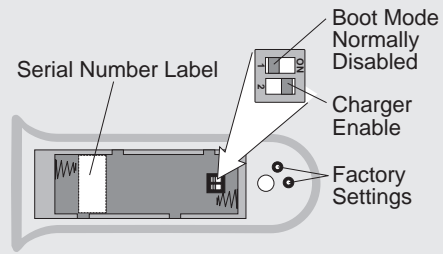

Figure 11: Location of DIP switches

Charging will terminate automatically once the batteries are fully charged, which takes approximately 3 hours for fully discharged batteries.

2.1.2 Sampling Probe*

The detachable probe houses the measurement chamber together with the associated optics, infra red emitter and receiver. Connect the probe by inserting the cable connector into the socket in the top end of the instrument case, with the red dot facing the front of the instrument to ensure correct pin location.

DO NOT pull on the cable to disconnect the probe.

Disconnect the probe and cable from the instrument ONLY by pulling outwards on the knurled sleeve, in the direction of the arrows shown in Figure 4. The probe may be un-clipped from the control unit for hand held operation.

2.1.3 Supporting the Instrument

For general monitoring applications the instrument may be fitted to a suitable tripod (available from Casella CEL).

Note*: Reading errors may be observed when using the instrument in very bright or changing ambient light conditions because the measurement method depends on the scattering of infra-red light. Therefore, exercise care when using in direct sunlight. Shield the probe from direct light sources and hold it steady while taking a reading. An aspirated or PUFF adaptor may be used to minimise light ingress.

2.2 Preliminary Operations

2.2.1 Switching ON and OFF

1. Press  to switch your MicroDust pro ON.

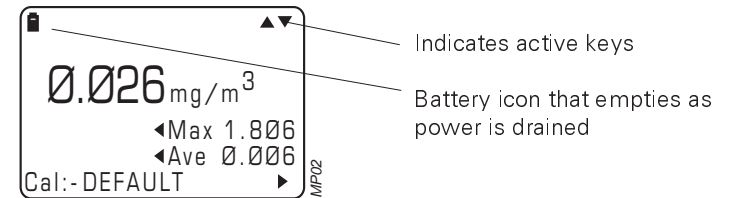

A welcome screen will be displayed showing the instrument's name.



When switched ON the readings may drift a small amount, so allow 1 minute for the instrument to warm up.



2. Before proceeding with measurement, it is recommended that you check that the zero and span (sensitivity) are correctly set and apply a calibration for the type of dust to be measured. These checks and calibrations are described in Section 2.3.

(Press  for a shortcut to Calibration.)

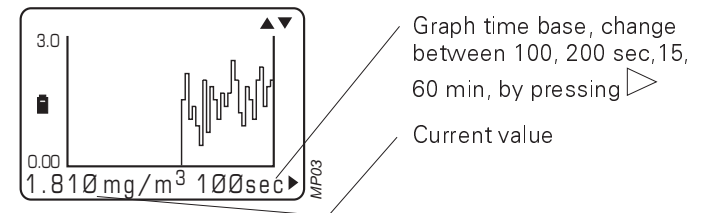
3. Press  to reset the Maximum (Max) and Average (Ave) levels.
4. Press  or  to display a profile graph of the current dust concentration.



This graph scrolls across the screen from right to left as samples are collected, with the current value shown at the right hand axis.

5. Press  or  again to return to the measurement display.
6. Press  for about two seconds to switch your MicroDust pro OFF.

2.2.2 Checking Battery Status & Firmware Version

The internal battery voltage is displayed on the Status menu, together with the instrument firmware (internal program) version.

1. Switch the instrument ON and wait for the measurement screen to be displayed, as described in Section 2.2.

2. Press  to display the Main menu.

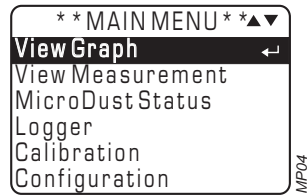

3. Use  or  to highlight the MicroDust Status option.

4. Press  to display the Status screen.

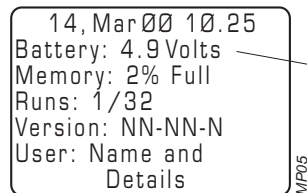

Ignore the displayed voltage when external power is being used



When the indicated voltage is greater than 4.8 V, the batteries are in a fully charged condition. If the voltage from rechargeable batteries is lower than 4.2 V, more than 80% of the capacity has been used.

Consider Recharging !

The battery icon will blink to warn that the internal battery is approaching discharge. When the batteries become discharged, logging is terminated and the instrument will commence an automatic shut down sequence.

2.2.3 Configuring for the Current Measurement

The Configuration menu enables all functions for the instrument's current operating mode to be defined.

1. With the Main menu on display (see Section 2.2.2), use  or  to highlight the Configuration option.



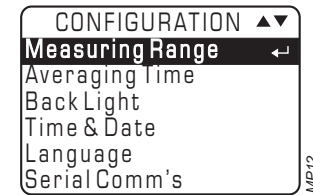

2. Press  to display the Configuration menu.



3. Specify the user language by pressing  while highlighting the Language option.

The following languages are available:

English,
Française,
Deutsch,
Italiano,
Español.





4. Use  or  to highlight the required language.
5. Press  to select the language and return to the Configuration screen.
6. Specify the measurement range by pressing  while highlighting the Measuring Range option.

The Dust Input Range screen is displayed.



The MicroDust *pro* has four measurement ranges (0 - 2.500, 0 - 25.00, 0 - 250.0 and 0 - 2500 mg/m³) plus an Auto Range setting.

It also has two graph settings:

Range Locked	Locks the Y-axis limits to the measurement range setting,
Auto Scale	The Y-axis is auto-scaled to accommodate only the range between the current maximum and minimum measurements.

7. Use  or  to select the Range option.
8. Use  or  to select a range suitable for the anticipated dust concentration, or set the instrument on Auto Range.

The Auto Range setting is suitable for the vast majority of sampling applications.

9. Use ▾ to move to the Graph option.
10. Use ◀ or ▶ to select a graph setting suitable for the anticipated measurements.
11. Press  to accept the settings and return to the Configuration menu.
12. Specify the averaging time and analogue output parameters by pressing  while highlighting the Averaging Time option.

The Averaging Time screen is displayed.

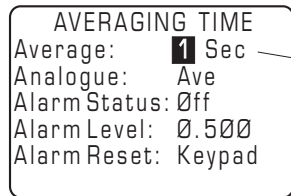

Early firmware showed only the Average field. Since Version 06, more fields have been displayed.

13. Set the averaging time.
14. Use ▾ or ▲ to select Averaging Time, and ◀ or ▶ to edit the entry.

The averaging time may be set in 1 second steps anywhere between 1 and 60 seconds.

The displayed dust concentration will then represent a rolling average taken over the specified time.

In some measurement applications where aerosol concentrations change rapidly, a longer averaging time will offer increased stability for the displayed value.

15. Select an analogue output data type (optional).
16. Use ▾ or ▲ to select Analogue, and ◀ or ▶ to edit the entries.
17. Choose from the following options.

Raw: The analogue output is taken directly from the signal conditioning circuit and is normalised to match the range of the instrument.

Average: Fast response shows sudden changes in dust concentration.
The analogue output is derived from the averaging time set in the instrument and provides a smoother instrument response.

Alarm: The output voltage will represent a set digital value where 2.5 V is Alarm On and 0 V is Alarm Off.

When Alarm is selected, the following additional options come into operation.

Status: On enables the alarm,
Off disables the alarm.

Alarm Level: Allows an alarm trigger level be set as xxx.xx (mg/m³ or mg/l). This mass concentration level is taken from the average reading selected in this menu. When the concentration level is equal to or greater than the alarm level, the alarm is triggered instantaneously.

Alarm Reset: Auto resets the alarm when the concentration level has fallen below the alarm level for more the 5 seconds. Keypad resets the alarm when any key is pressed.

18. When all required settings for the proposed task have been selected, press  to accept them and return to the Configuration menu.

19. Specify the display back light function by pressing  while highlighting the Back Light option.

20. Choose from the following options:

Light ON The display is lit as you leave this screen. It remains lit until switched off.

Light OFF Switches the backlight off.

Keypress ON The display is lit each time a key is pressed while viewing a menu. It remains lit for the duration set.

Duration Sets the duration timer.

The duration may be set in 1 second steps anywhere between 5 and 30 seconds.

21. Press  to accept the setting and return to the Configuration menu.

22. Specify the time and date by pressing  while highlighting the Time & Date option.

The instrument has an internal real-time clock, which should be set to the current time and date. When data is being logged, the dust concentrations will be recorded against the current date and time. When the instrument is configured by WinDust pro PC software, the time and date on the internal clock are set automatically to the PC's time and date. Please refer to Chapter 3 for details.

23. Use  or  to select Set Time or Set Date.

24. Press  to display the Set Time or Set Date screens.

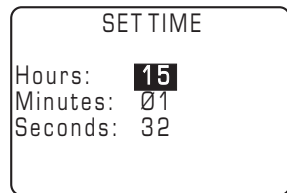

MP18

SET TIME

Hours: **15**

Minutes: 01

Seconds: 32

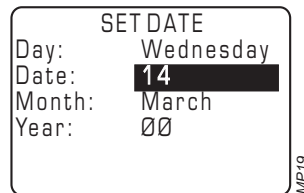

MP19





SET DATE





Day: Wednesday

Date: **14**

Month: March

Year: 00

25. Use  or  to select a time or date field to be edited and  or  to edit the entry in the selected field.

26. Use  or  to select other date or time fields and  or  to edit the entries.

27. When all entries on the time or date screen are correct, press  to accept the settings and return to the Time & Date screen.

28. Specify the serial communication details by pressing  while highlighting the Serial Comm's option on the Configuration menu.

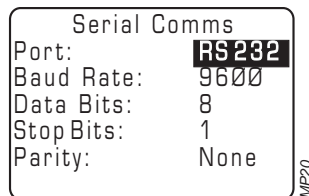

MP20

Serial Comms

Port: **RS232**





Baud Rate: 9600

Data Bits: 8

Stop Bits: 1

Parity: None

The Serial Port screen is displayed.

29. Use  or  to select Port or Baud Rate, and  or  to edit the entry in the selected field.

30. When the entries match the requirements of your PC (also see Section 3.3.1), press  to accept the settings.

2.3 Calibration

Before making any dust measurements, it is necessary to confirm that the instrument is correctly zeroed and that its span control (sensitivity) is correctly adjusted.

For optimum accuracy, it is recommended that you also perform a user calibration to correct your instrument for the type of dust to be measured.

2.3.1 Checking Zero and Span

1. Select the Calibration option from the Main menu.
2. Display the Calibration menu. The calibration menu can also be displayed by pressing  while viewing the measurement screen.

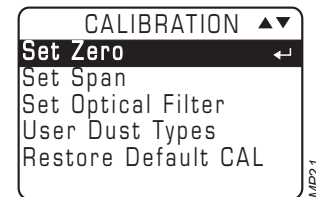

When the instrument is to be calibrated for a specific type of dust and/or a correction factor applied to the measured readings, refer to Section 2.3.2.

3. Select the Set Zero option.

For sensitive measurements that will use the 0 - 2.5 or 0 - 25 mg/m³ ranges, it is important to purge the probe with clean air prior to checking or performing any zero adjustments. Fine dust particles in the probe assembly may never settle, even with the probe collar covering the inlet chamber.
4. Slide the probe collar over the inlet to the measurement chamber, leaving only a small hole from which the purge air can vent.
5. Attach the purge bellows (supplied) to the probe purge inlet (shown in Figure 12) and rapidly squeeze the bulb 5 or 6 times.

This action will inject clean air into the chamber, and remove possible contamination which may have settled on the surface of optical components within the probe. The user will probably see the indicated concentration increase and then decrease towards zero.

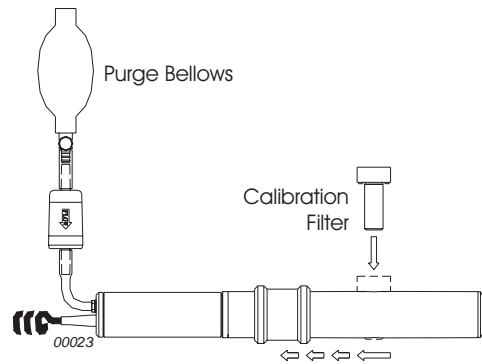



Figure 12: Inserting the Calibration Filter

6. Allow a few seconds for auto-ranging and for the reading to stabilise.
If the reading does not stabilise, rapidly squeeze the bulb a further 5 or 6 times and try again.

7. Once the reading is stable, press .

The instrument will now set the reading to zero, ± 1 digit.

If the reading is not within ± 1 digit of zero, wait a few seconds then press  again until it is.

When it is not possible for the instrument to zero itself on the 0 - 2.5 mg/m³ range, a "Contamination Warning" message will be displayed and a higher range selected. The 0 - 25 mg/m³ range will then become the lowest useable range until the probe is cleaned. However, for accuracy and stability it is recommended that factory cleaning take place.

8. Once the instrument has been set to zero, ensure that the rubber cap is re-fitted to the purge inlet.
9. Select Set Span from the Calibration menu, so that the factory calibrated span can be checked.

The basic span (or sensitivity*) of the instrument and probe is set at the factory using ISO (Fine 12103-1 A2) calibration dust.



Note*: All light scattering instruments can have some sensitivity to a particulate's refractive index, size, shape and colour. The MicroDust pro uses a narrow forward scattering angle to minimise these effects, but for optimum calibration to a specific dust type, gravimetric calibration may be required. This is described under calibration for a specific dust type in Section 2.3.2.

Each probe is supplied with its own calibration filter that creates a fixed optical scattering effect within the sampling space. This fixed reference can be used to confirm the factory calibration point for the instrument and probe.

Use only the optical filter supplied for use with the probe.

The reference value for the calibration filter supplied for the probe is shown on the filter and is also displayed at the bottom of the Set Span screen.

10. Insert the calibration filter into the measurement chamber with the arrow pointing towards the probe handle.
11. Press  and wait a few seconds for the reading to stabilise.

The display should give a reading within ± 1 digit of the value shown on the calibration filter to confirm that the factory set sensitivity of the instrument has not been changed.
12. If the correct value is not displayed (for example because the instrument was last used with a different probe and filter) display the Set Optical Filter screen.
13. Press  and edit the entries to match the information given on the filter.
14. Press  to accept the changes.

This is an absolute calibration of the instrument that remains valid when a correction factor is applied. After calibration, if the probe becomes heavily contaminated, a warning will be displayed and the contaminated ranges disabled.

2.3.2 Calibrating for a Specific Dust Type

All light scattering instruments exhibit some sensitivity to a particulate's refractive index, size, shape and colour. When faced with varying dust types, the sensitivity of the instrument will differ slightly due to variations in particulate size, refractive index and colour. The MicroDust *pro*'s use of a narrow forward scattering angle minimises these effects but for optimum calibration to a specific dust type, gravimetric calibration may be required.

The optional gravimetric and respirable adapters incorporate 25 or 37 mm filter cassettes and provide a convenient method of gravimetrically calibrating MicroDust *pro* instruments. Standard gravimetric techniques can be used with the modules to give a cross check between the readings of the MicroDust *pro* and a weighed sample. This is achieved by collecting two

averages over the exposure period, one from the filter and the other provided by the averaging function of the instrument. If differences are found between the instrument's reading and the gravimetric value, a user defined correction factor can be loaded into the instrument for the dust type. This correction can be applied automatically to any measured values to give optimum accuracy.

During the calibration run, it is necessary to determine the average real time dust concentration which has been measured by the instrument. The internal logger makes the recording and analysis of this data a simple task.

Use the following procedure to calibrate for a specific dust type.

1. Perform the Set Zero operation and confirm that the Span is set to the factory calibration point (Section 2.3.1).

This returns the instrument to the default calibration set by the factory so that all user defined calibrations are relative to this setting. This is an absolute calibration that is not affected by changes to the correction factor.
2. Fit the Gravimetric or Respirable adapter on to the probe and load a pre-weighed filter into the cassette holder.
3. Adjust the sampling pump to provide the appropriate flow rate.

The respirable adapter requires a flow rate of 2.2 l/min.

For isokinetic sampling, pump flow rate is calculated from the sample velocity and cross sectional area of the gravimetric inlet tube (2 cm²). For general TSP measurements, actual flow rate is not critical but will affect the mass of the collected sample.
4. Start gravimetric sampling and the internal logger (Section 2.5.3).

This resets the Average (T.W.A) value.
5. Continue sampling for a period long enough to allow the collection of sufficient sample mass.
6. At the end of this sampling period, stop the data logger and sampling pump.

The average real time reading is available from the display and will be stored in the data file for the run.
7. Note the Average (T.W.A) value.
8. The filter should be conditioned and re-weighed to establish the collected mass.
9. The gravimetric density during the sampling period can be established by dividing the mass increase by the total volume sampled.

The calibration correction factor is calculated as:

$$\text{Correction Factor} = \frac{\text{Gravimetric Concentration}}{\text{Instrument Average Reading (T.W.A)}}$$

Example:

Filter mass increase = 3.21 mg
 Volume Sampled = 0.75 m³ (based on flow rate and sample time)
 Gravimetric density = 3.21 / 0.75 = 4.28 mg/m³
 T.W.A indication over period = 3.45 mg/m³ (i.e. the instrument reads low)
 Correction factor = 4.28 / 3.45 = 1.24

This correction factor can also be calculated automatically using the WinDust pro software. (See Section 3.7).

2.3.3 Applying the Calibration

1. Check the zero and span settings as described in Section 2.3.1.
2. Select the User Dust Types option from the Calibration menu.

A list of the current dust types is displayed, with the active type marked √.

Dust Name	OPT
0] DEFAULT	√
1] LIMESTONE	
2] SITE 4	
3] SITE 5	
4] ROAD STONE	

The default dust type is a factory calibration that cannot be edited or deleted. It is based on measurements using ISO Fine 12103-1 A2 (equivalent to Arizona Road Dust).

3. Move to an existing dust name (not Default) or to an empty space.

4. Press  to step through the following options:

"√" The active dust type,
 "del" Deletes this dust type,
 "set" Sets a name and correction factor,
 " " This type stored but inactive.

5. Select "set" and press .

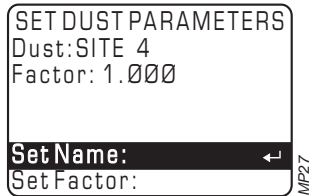

```
SET DUST PARAMETERS
Dust: SITE 4
Factor: 1.000
Set Name:
Set Factor:
MP27
```

6. Select Set Name and press .

7. Edit the name, then press  to store the new name and return to the Set Dust Parameters screen.

8. Select Set Factor and press .

9. Set the correction factor according to your calculation (Section 2.3.2).

10. When the instrument is used to measure this particular type of dust, load the appropriate type from the Dust Name screen so that the correction factor is applied automatically to the measured values.

2.4 Measurement

Before carrying out measurement, check the zero and span as described in Section 2.3.1, calculate and apply a dust correction (Sections 2.3.2 and 2.3.3) and select an Averaging Time and Range appropriate to the monitoring application (Section 2.2.3).

With the measurement chamber aperture exposed, slowly move the probe through the aerosol or rely on natural air movement. Measurements can be taken with the probe either clipped to or unclipped from the display unit. For static monitoring applications the use of an aspirator system is preferred (refer to the Sampling Accessories sections in Chapter 4).

Any dust deposited on the surface of optical components should be blown clear. To prolong the serviceable life of the instrument, it is recommended that this operation be performed before and after each use.

In addition to the basic real time dust indication, the MicroDust *pro* is able to calculate and display other useful data values as follows.

2.4.1 Maximum Value (Max.)

This value represents the maximum dust concentration that has occurred in any one second period since the instrument was switched ON, reset

manually by pressing  or logging started. The maximum value cannot be reset while the logger is active.

2.4.2 Time Weighted Average Value (Ave)

The time weighted average value represents the running average dust concentration since the instrument was switched ON, reset manually by pressing  or logging started. The average value cannot be reset while the logger is active.

2.5 Data Logging

2.5.1 Configuring the Logger

Before storing data, the logger should be configured for the proposed measurements.

1. From the Logger menu, select and display the Config Logger screen.

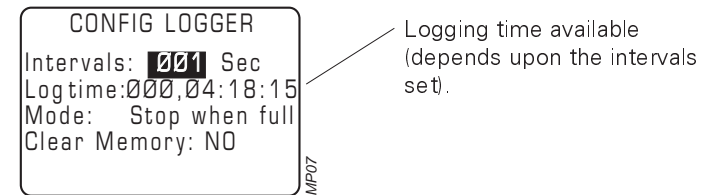

2. Select logger Interval.
The logger interval is the time between each recorded data point. Intervals can be set between 1 and 600 seconds.
3. If necessary, change the current setting.
4. Select logger Mode.
The logger mode determines what happens when all empty memory locations have been filled with data.
5. If necessary, change the setting to one of the following alternatives:

Overwrite RUN	The logger simply carries on recording data so that the oldest records will be overwritten by new ones.
Stop When Full	The logger stops logging when the memory is full.

2.5.2 Clearing the Logger Memory

The MicroDust *pro* has a logging capacity of over 15,700 data points and 32 runs, with the total number of stored runs shown on the Status screen.

When there is not sufficient space remaining in the instrument store for the projected logging run, stored data can be deleted. All recorded data should be downloaded before clearing the logger's memory as there are no facilities to recover data deleted from the instrument.

1. Select and display the Config Logger screen (see Section 2.5.1).

2. Highlight the Clear Memory option, select YES then press .

A warning message will be displayed asking for confirmation before the contents of the memory are erased.

3. Press  to confirm the erase operation.



ALL stored runs will be DELETED.

2.5.3 Start Logging

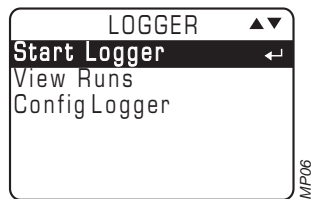
1. With the logger settings configured as described in Section 2.5.1, (and the memory cleared when necessary) display the Logger screen.



2. Highlight the Start Logger option and press  to start logging.

A measurement screen will be displayed showing the current dust concentration.  and  can be pressed to switch between the measurement screen and a graphical representation of the concentration.

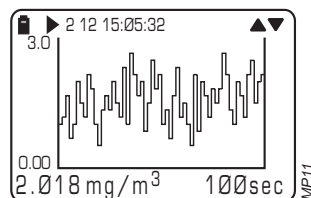
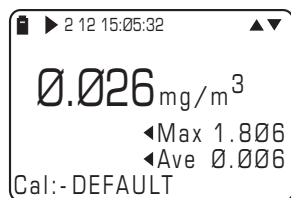

Both screens identify the run and show the current interval number. Data stored during the current (or other runs) can be reviewed on the instrument display while it is being collected.

4. From the Logger screen, select and display the View Runs screen.

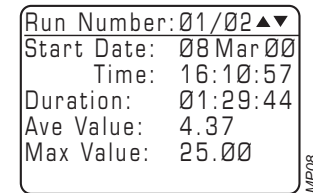

Run Number: 01/02 ▲▼
Start Date: 08 Mar 00
Time: 16:10:57
Duration: 01:29:44
Ave Value: 4.37
Max Value: 25.00

A summary screen for the earliest stored run will be displayed.

5. Use ▼ or ▲ to select summaries from other runs.

The run number and total of runs will be indicated. The current run will also be available.

6. When sufficient data has been collected, stop logging by returning to the Logger screen and using the Stop Logger option.

Logging stops and data up to the last completed interval is saved. Each saved record contains the average concentration during the logging interval, together with the date and time when it was saved.

At the end of each logging run (i.e. when logging is stopped or the instrument switched off) a summary record will also be saved.

This identifies the average and maximum concentrations that have occurred during the entire run. The time and date of the maximum concentration are also saved.

Stored data can be downloaded for further manipulation and reporting only by using WinDust pro Application Software.

3. WINDUST *pro* APPLICATION SOFTWARE

WinDust *pro* Application Software supports the data logger facilities offered by the MicroDust *pro*. It is specifically written by Casella CEL to simplify the process of instrument configuration, downloading and data presentation.

Applications

- ✘ Monitoring respirable dust levels
- ✘ Work place monitoring
- ✘ Process monitoring
- ✘ Walk through survey
- ✘ Evaluation of filtration equipment performance
- ✘ Ambient air quality
- ✘ Detection of total dust emissions
- ✘ Indoor air pollution monitoring

The application, supplied on two 1.4 MB 3¹/₂" floppy disks, is designed to operate within the 32 bit environment of Windows 95 and later or Windows NT 4 and later.

The instrument communicates with the PC using an RS 232 serial port.

3.1 Installation on Windows 95™, 98™, ME™, Windows NT™ & Windows 2000™

System Requirements:

IBM™ compatible PC with Pentium or better processor,
At least 8 MB of free RAM space,
Microsoft Windows 95/98/ME/NT, Windows 2000,
Hard drive with at least 4 MB of free space,
RS 232 Serial Communication Port,
3¹/₂" high density (1.4 MB) floppy disk drive for program installation,
Super VGA colour monitor,
Printer - optional.

Before installation, it is recommended that a back-up copy be made of the program disks. Keep the originals in a safe place and use the copy to install the software. The Setup program for WinDust *pro* will install files in the specified Program directory and also in the Windows\System directory.

1. Start Windows.
2. Insert WinDust *pro* Disk 1 into the floppy disk drive.
3. Select **Start** from the task bar, then **Run...**

4. Type **a:\setup**, where "a" identifies the floppy disk drive, then press **Enter**.
5. Wait for the Casella CEL welcome screen to be displayed, then follow the on-screen instructions.

Once installation is complete, a WinDust *pro* icon will be found on your Windows desktop.



3.2 Starting WinDust *pro*

Start WinDust *pro* by double clicking on its desktop icon, or selecting it from the Start Menu. The top level window will be displayed.

As the cursor is moved to each menu button, the relevant function will be displayed on the message line at the bottom left of the display.

If this is the first time that you open the newly installed software, a dialog will be displayed telling you that no profile has been defined and asking you to create and select one before proceeding. Your only option is to click **OK**, which displays the Active Profile dialog, (see Section 3.3.1).

3.3 Profiles

Profiles are used to identify the unique operating parameters of each instrument or measurement application.

In situations where multiple instruments are interrogated by one PC, the use of profiles provides a convenient way of identifying and managing data from each instrument. Profiles are stored in the PC.

3.3.1 Creating/Editing a Profile

1. Create a new profile by selecting the **Profiles** option on the **Edit** menu, or by clicking .

You will be presented with the Active Profile dialog where the active profile is highlighted.

2. Select **New** or **Edit** as appropriate.
3. Enter a suitable name in the Profile Name dialog for a new profile, or select an existing name.

Three tab Properties dialogs define the basic features of the profile.

The **Instrument** dialog specifies instrument type, date format, ID and selects a pre-drawn 128 wide by 64 high, black and white bitmap (**.bmp**) for use as a welcome screen

4. Make sure that instrument type **Pro** is selected.
5. Make suitable entries in the other fields.

In addition to normal alpha-numeric characters, the following may also be used in the messages, " + - : () + - # and SPACE".

The **Communications** dialog configures the RS 232 serial interface and specifies Modem details. See Figure 13.

6. Make entries in the **Comms** fields to suit the PC and communications port in use.

Default settings for a MicroDust pro are shown, so that only the **Port** may need to be defined. If a mouse or other device is already installed on Com1, then change the entry to another free port.

7. When a modem connection is to be used, select **Comms via a modem** and make entries in the **Modem** fields to suit the modem in use.

The default settings match those of typical modems, so the only parameter that must be entered is the phone number at **Dial**.

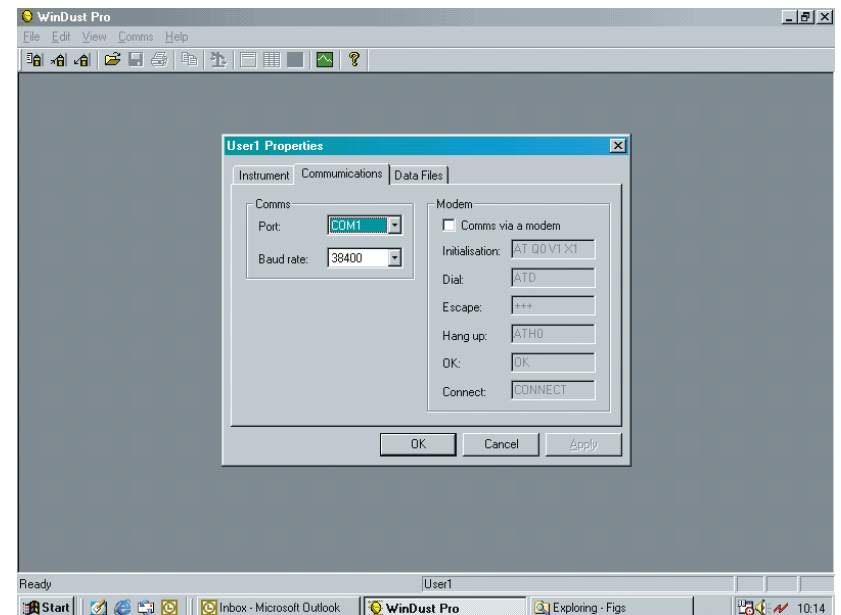

Figure 13: The Communications dialog

The **Data Files** dialog specifies a file prefix and store location for the data files to be downloaded.

As the instrument may contain data from many different sampling runs, the downloaded data will be split into individual files, each one representing a single run.

The **File Prefix** defines the first six characters of the file name for downloaded data. You may want to add a hyphen (as shown below), to separate the date from the prefix. The last two digits are a unique number allocated automatically as each series of runs is downloaded.

For example, if the data directory already has files identified as:

Factory-08-02-00-01.DAT
Factory-08-02-00-02.DAT

and the instrument contains two sampling runs, after downloading the files will have been added to the end of the list as follows.

Factory-08-02-00-01.DAT
Factory-08-02-00-02.DAT
Factory-08-02-00-03.DAT
Factory-08-02-00-04.DAT.

A warning will be given if the software detects that more than 99 files with the current prefix are to be downloaded. If this occurs, define a new file prefix before commencing download.

8. Make a suitable entry.
9. When the default directory is not suitable, select a file path and directory for storing data files.
10. Click **OK** to save the information in the profile.
11. Accept this as the active profile.

3.3.2 Sending a Profile to the Instrument

The configuration information contained in an instrument profile must be transferred to the MicroDust *pro*. Before attempting to send a profile, make sure the instrument is switched on and the serial communications cable plugged into both the instrument and the appropriate port on your PC.

1. Select **Send Profile** from the **Comms** menu, or click .

A message will be displayed, warning that this procedure will erase all data in the instrument and asking if you want to continue.

2. Start the transfer.

Any errors will be reported and the transfer aborted.

During the transfer, the instrument's internal clock will be reset using the date and time from the PC. (Ensure the PC's clock is correctly set !)

3.4 Downloading Data from the Logger

Before you can generate graphs and tables from the data recorded by your MicroDust pro, you must download it to your PC.

1. Make sure the instrument is switched on and the communications cable plugged into both the MicroDust and the appropriate serial port on your computer.
2. To start downloading, select **Download** from the **Comms** menu, or click .

The download sequence can be followed on the PC screen.

Data from individual sample runs will be saved in separate files with each file being allocated a unique index number. (See Section 3.3.1.)

3.5 Presentation of Data

Three data presentation options are available: summary, graph and table.

When data is displayed using any of these options, use **Print** from the **File**



menu, or click  to print a hard copy of the current information or graph on a printer attached on-line to your PC. The **File** menu offers **Print Preview** which allows you to check how the printed material will appear on the page.

Use **Copy** from the **Edit** menu, or click  to copy the current information or graph to your PC clipboard, from where it may be pasted into other applications. Data files that contain more than approximately 500 records may be too large to be copied in this way. Therefore when they contain more than 500 records, it is recommended that they be imported using external software such as Microsoft™ Excel or Word. See Section 3.5.4.

The font used to display the summary, graph scales and table can be modified by selecting **Font** from the **Edit** menu to obtain a Font selection dialog.

3.5.1 Displaying the Data Summary

Before reviewing a data file stored on the PC, you must open it as follows.

1. Select **Open** from the **File** menu, or click 
A dialog will be displayed that allows you to select the data file to be opened.
2. Select and open the required data.
The data summary will be displayed. This is the starting point for accessing all analysis displays available within the WinDust *pro* software.
It shows maximum and minimum dust concentrations, the dates and times when they occurred and the average concentration during the whole run. See Figure 14.
Once the file is active, graph and table displays can be opened.
2. At any time, the Summary screen can be recalled to the display by selecting **Summary** from the **View** menu or by clicking .

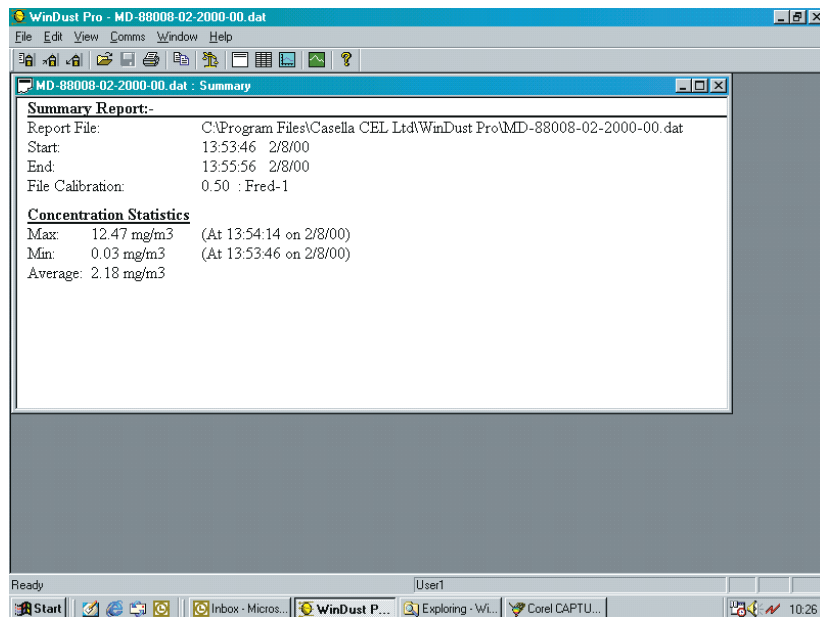



Figure 14: The Summary window

3.5.2 Displaying Data as a Graph

1. Open the file you want to display as a graph, as described in Section 3.5.1.

2. Select **Graph** from the **View** menu or click .

The graph will be displayed as shown in Figure 15. Both axes of the graph are scaled automatically to cover the full range of dust concentrations stored and the entire time period contained in the data file.

3. To enlarge a section of the graph for closer inspection, position the mouse pointer at the point on the time axis where you want the new display to start.

4. Hold down the left mouse button while dragging to the right until the highlighted portion covers the section of the graph you want to expand.

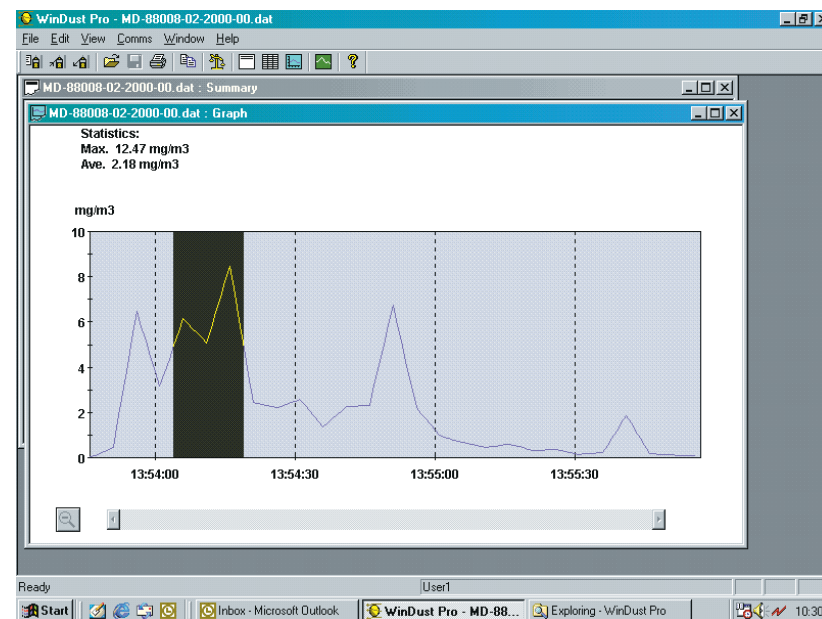

Figure 15: The Graph window with a portion marked for expansion

Note: The peaks shown on the graph are averaged over the logging interval and in consequence may be different from the maximum instantaneous value shown in the corresponding summary.

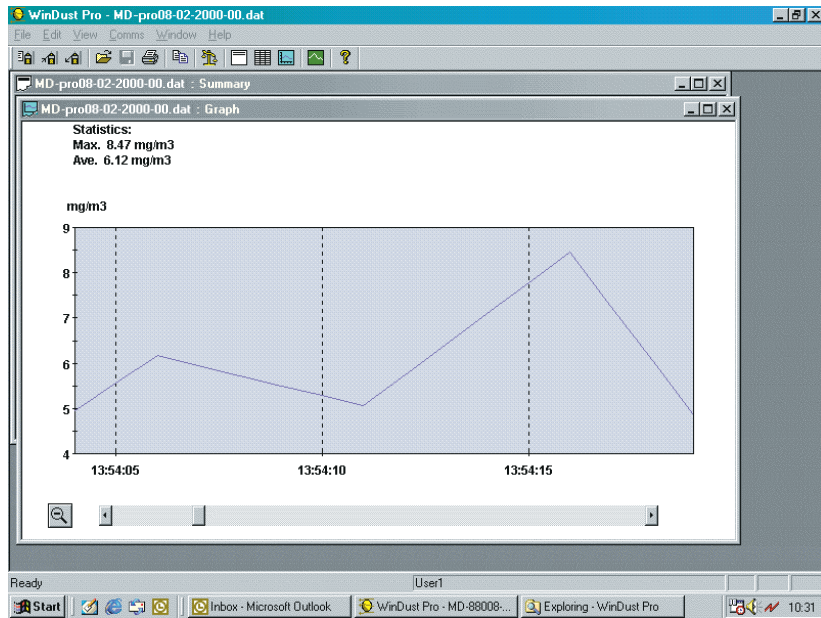



Figure 16: The expanded graph

The graph is redrawn with the selected portion expanded to fill the whole frame (shown in Figure 16).

3.5.3 Displaying Data as a Table

Displaying the information as a table allows you to see the actual values stored, together with the date & time of their occurrence.

1. Open the file you want to display as a table, as described in Section 3.5.1.
2. Select **Table** from the **View** menu or click .
A table that includes all of the records in the file will be displayed, as shown in Figure 17.
3. Use the vertical scroll bar to move up and down within the table.

3.5.4 Exporting Data to Other Applications

Windust *pro* data files (**.dat**) can be imported into other applications.

Data files created by WinDust *pro* are saved as comma delimited ASCII text. Each set of readings is saved as a single line terminated by a carriage return/

Date	Time	mg/m ³
2/8/00	13:53:46	0.03
2/8/00	13:53:51	0.45
2/8/00	13:53:56	6.47
2/8/00	13:54:01	3.15
2/8/00	13:54:06	6.16
2/8/00	13:54:11	5.06
2/8/00	13:54:16	8.47
2/8/00	13:54:21	2.44
2/8/00	13:54:26	2.19
2/8/00	13:54:31	2.59
2/8/00	13:54:36	1.34
2/8/00	13:54:41	2.25
2/8/00	13:54:46	2.33
2/8/00	13:54:51	6.74
2/8/00	13:54:56	2.19
2/8/00	13:55:01	0.99
2/8/00	13:55:06	0.66
2/8/00	13:55:11	0.45
2/8/00	13:55:16	0.60

Figure 17: The Table window

line feed pair. These files are easily imported into many commercial word processor and spreadsheet applications such as Microsoft™ Word and Excel.

3.6 Real-Time Display Mode

The WinDust *pro* application is able to provide a real time graphical display of the MicroDust *pro* current reading. A scrolling real time graph provides a clear indication of changes in dust concentration as they occur. Before using the real time display facility, ensure that your MicroDust *pro* is switched on and connected to the appropriate serial port of your PC.

1. Select **Real Time** from the **Comms** menu, or click .
The real time window will be displayed. A measurement profile for the run will start immediately scrolling from the right, as shown in Figure: 18.
2. The Summary area shows the maximum, average and minimum concentration measurements (mg/m³) encountered during the current run.

Press the **Reset** button to clear existing values.

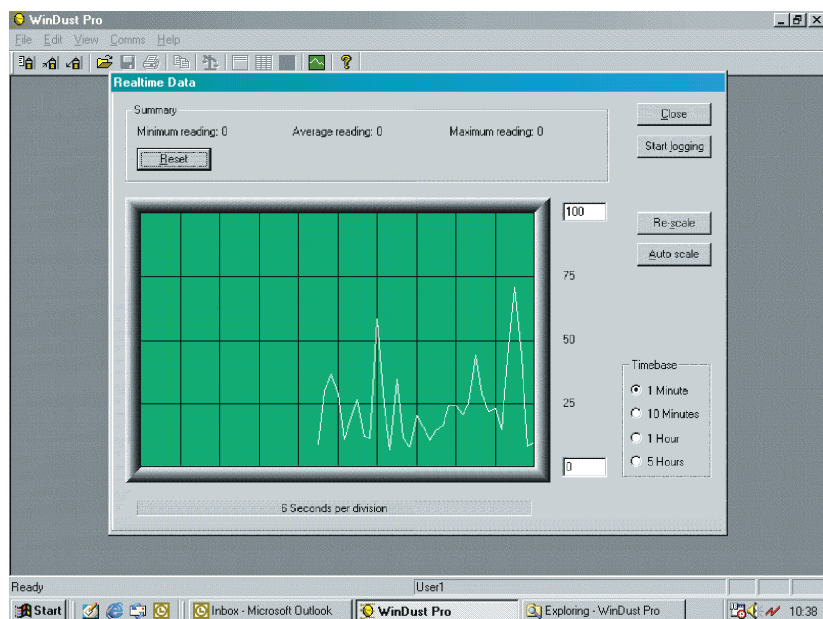

Figure 18: The Real-Time window

3. The boxes on the Graph y-axis show the display range.
Click inside the boxes and type the desired values, then use the **Re-scale** button to change this range.
The intermediate values will be adjusted automatically.
4. Use **Auto Scale** to allow the y-axis to accommodate the maximum and minimum values.
It is suggested that you let the run progress long enough to encounter typical maximum and minimum values before using **Auto Scale**.
5. Press one of the buttons in the Timebase area to select an x-axis time base period of:
1 minute , 10 minutes, 1 hour, or 5 hours.

3.7 Gravimetric Correction by WinDust pro Software

Data files stored by the PC may be automatically scaled and correlated to a gravimetric filter result. This ensures optimum calibration to suit local measurement conditions (Particle size, shape and chemical composition).

The gravimetric correction function automatically compares a true gravimetric concentration of dust with the corresponding data stored in the PC date file.

1. Load the relevant data file, as described in Section 3.5, ensuring that it corresponds with the gravimetric result.

The data summary will be displayed.

2. Select **Calibration** from the **Edit** menu or click .

A dialog will be opened.

If the file has already been corrected for gravimetric results, a warning will be given. (To remove an existing correction refer to Step 7.)

3. Enter the gravimetric filter result in the Gravimetric Sample field (i.e. the gravimetric density determined as in Section 2.3.2).
4. When required, enter information in the relevant field to identify the calibration for the file.
5. Select **OK** to proceed.

The software compares the gravimetric result with the measured average from the file and calculates a gravimetric correction factor.

When a graph or table is displayed for this file, the correction factor will be applied automatically to the data so that corrected results are displayed.

When the corrected graph or table is closed, you will be asked to save the changes in the file.

6. If required, select **Yes**.

The modified file will be saved with the original file name and extension (**.dat**).

7. If you want to remove any corrections applied to a datafile, activate the correction function and enter "0" in the Gravimetric Sample field.

The existing corrections will be removed.

4. SAMPLING ACCESSORIES

When used in static monitoring applications, the sampling probe's measurement chamber should have some form of aspiration, either in the form of an Apex (or Vortex) sampling pump or a fan aspirator unit.

Maintaining airflow through the probe eliminates potential errors due to orientation of the probe inlet and size selectivity.

The gravimetric and respirable adapters incorporate 25 or 37 mm filter cassettes and provide a convenient method of gravimetrically calibrating MicroDust *pro* instruments.

4.1 Gravimetric Adapters

The gravimetric adapter units may be used in conjunction with a sampling pump to enable all sampled particulate matter to be drawn through the probe measurement chamber and then deposited on to a 25 or 37 mm filter. There are three gravimetric adapter options available.

Total Suspended Particulate (TSP)

All sampled particulate is monitored in real time and then deposited on to a sample filter. The design provides no size selective characteristics.

Respirable (4 µm)

The respirable adapter design incorporates a Cyclone size selective unit. Only the respirable fraction of particulate passes through the probe and is deposited on to the filter.

PUF (Polyurethane Foam Filter)

The PUF gravimetric adapter uses foam filter inserts to provide size selective sampling characteristics. Filters are available for PM₁₀, Respirable (4 µm) and PM_{2.5} size fractions.

All components fit together using "O" rings for sealing. These should be checked for signs of damage, which may result in erroneous readings due to air leakage. The adapters enable standard gravimetric techniques to be used and provide a cross check between the readings of the MicroDust *pro* and a weighed sample.

If errors are found between the instruments reading and the gravimetric value, a correction figure can be determined and applied to give a closer correlation of the two readings. (Please refer to Calibrating for a Specific Dust Type in Section 2.3.2.)

The sampling probe should be inserted into the adapter block and correctly aligned over the sample inlet. The locating spigot of the Cyclone, TSP inlet tube or PUF filter holder should be inserted into the probe's sample inlet so that the complete assembly cannot rotate or move laterally on the probe.

4.2 TSP / Respirable Adapters

The basic design of the TSP and respirable adapters is the same, but with different inlet fittings. The respirable adapter uses the Cyclone principle of dust separation to draw only the respirable fraction of particulate matter through the measurement chamber and on to the filter (D50 cut = 4 µm at 2.2 l/min).

The cyclone is fitted to the mounting block using an "O" ring seal. A suitable constant flow pump set for 2.2 l/min such as the Casella Apex, Apex pro, Vortex Standard 2, or Timer 2 should be connected to the filter cassette assembly using silicone tubing.

The cyclone must operate in the upright position and the "coarse dust container" (rubber grit pot) should be cleaned periodically and checked for damage.

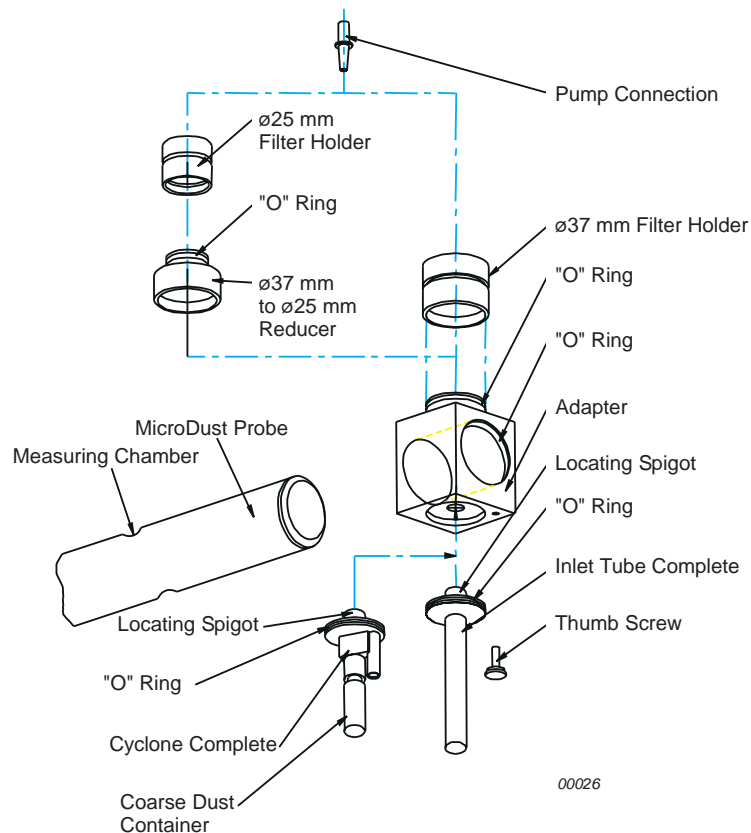

Figure 19: Arrangement of Gravimetric and Respirable adapter modules

When mounting a filter in the clear plastic cassette assembly, ensure the filter is held firmly against the filter support pad, a loose filter will give incorrect results.

When the Cyclone is pressed into the mounting block, the Cyclone spigot should locate in the probe so that the complete assembly cannot rotate or move laterally on the probe. Secure in position using the thumb screw.

4.3 PUF Filter Adapter

The MicroDust polyurethane foam filter (PUF filter) adapter may be used for PM₁₀, respirable and PM_{2.5} sampling applications using a flow rate of 3.5 l/min. The design is based upon the Conical Inhalable Sampler (CIS) identified in the Health and Safety Executives publication, MDHS14.

For monitoring applications the adapter is fitted to the MicroDust *pro* probe as shown in Figure 20.

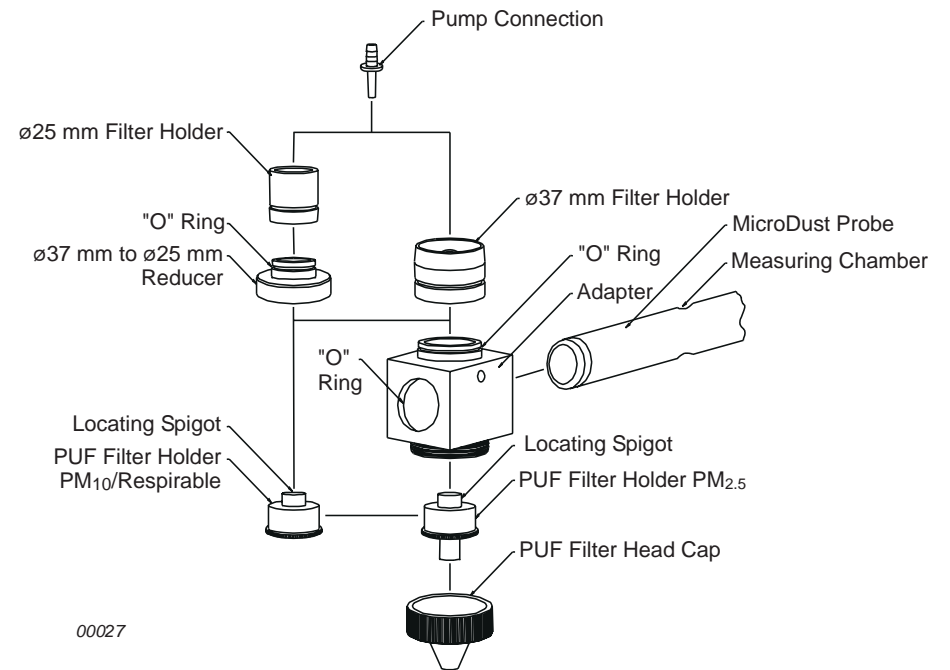

Figure 20: Installing the Adapter

Sample air is drawn through the PUF filter and then into the MicroDust *pro* measurement chamber before being deposited on to either a 25 or 37 mm filter.

The type of foam filter loaded into the adapter determines the size of particulate matter being monitored by the MicroDust *pro* and collected on the filter.

Although the PUF foam inserts have been designed as size selective filters to capture particles larger than a specified mean aerodynamic size, it is also possible to pre/post weigh the PUF inserts to establish both the total suspended particulate (TSP) value and the desired size fraction.

Storage of PUF Filters

PUF filters should be kept in a clean and preferably air-conditioned environment.

Inserting / Removing PUF Filters

PUF filters should be carefully inserted or removed from their respective cassettes using clean tweezers and plastic gloves. Avoid subjecting the filters to physical damage, creasing or folding.

PUF Filter Spares List

PM _{2.5} foams (packet of 10)	P118204
PM ₁₀ foams (packet of 10)	P118206
Respirable 2 foams (packet of 10)	P118208

4.4 Aspirator Unit

The fan driven aspirator unit may be used to draw all suspended particulate matter through the probe provided no back pressure is present. The unit is assembled as indicated in Figure 21.

The aspirator and inlet tube are a push fit in the mounting block. When assembling the units together, care should be taken to prevent damage to the "O" rings. The complete assembly is located and secured to the measurement probe with the spigot of the inlet tube engaging into the measurement chamber aperture.

A 5 V DC mains adapter unit or battery pack can be used to power the aspirator fan.

The aspirator unit should be cleaned periodically to ensure that an accumulation of dust does not result in erroneous readings or mechanical seizure.

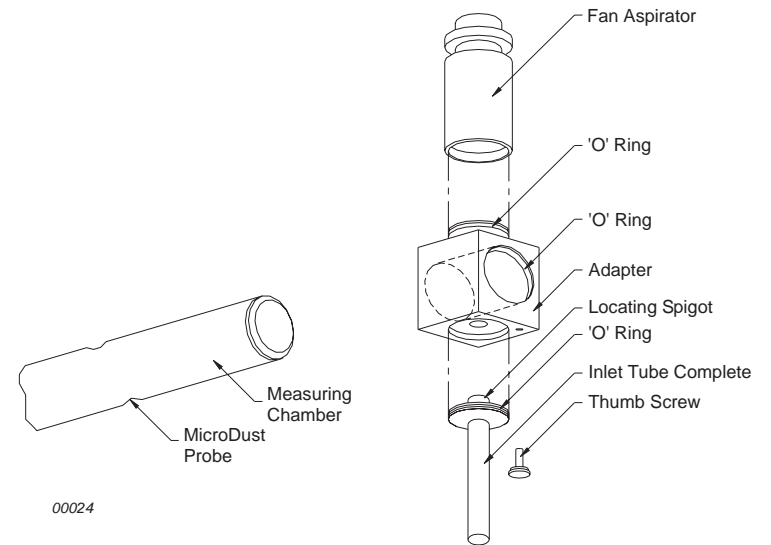

Figure 21: The Aspirator Unit

5. MAINTENANCE & SERVICING

5.1 Service Department

Casella CEL's in house service department offers a comprehensive range of repair and calibration services, designed to effect a fast and efficient back-up for all our products. The Service Department is operated under the scope of our BSI registration for products manufactured by us. We will however, undertake the repair of other manufacturers equipment. For further information please contact our service department at our Bedford headquarters. We will be happy to provide quotations for individual repairs or provide annual maintenance under contract.

We recommend factory service by technicians trained and equipped to repair your instrumentation. Should you wish factory repair assistance, send your equipment in a package equivalent to the original packaging. Insure to full value and ship pre-paid. Include a letter giving full details with your packing list.

Send to: Casella CEL Ltd
(Service Department)
Regent House
Wolseley Road
Kempston
Beds MK42 7JY
United Kingdom

For service outside the United Kingdom, please return to our appointed distributor.

5.2 Lens Contamination

As with all optical dust measurement equipment, lenses may eventually become contaminated with particulate that has settled on the surface. In the long term, this can reduce the instrument's reading for a given dust concentration or cause difficulty in achieving a stable zero indication. By careful design of the optics and measurement chamber, the need for regular cleaning of the lenses has been greatly reduced.

5.2.1 Long Term Monitoring

For long term sampling or where high contamination levels are anticipated, continuous purging by a source of dry filtered air is recommended. Use one of the pumps from the Vortex series. The flow rate to the purge inlet should be maintained at approximately 10% of the main sample rate.

When continuous purging is adopted, it is necessary to draw the aerosol through the probe's measurement chamber using an aspiration technique.

If this is not done, the clean purge air emerging from the measurement chamber will prevent entry of particulate matter.

5.2.2 Cleaning

When it is suspected that lens contamination has occurred (recognised by the inability to zero or calibrate the instrument correctly), attach the air purge bellows to the probe inlet and pump vigorously with the measurement chamber open. Any dust deposited on the surface of optical components should be blown clear.

To prolong the serviceable life of the instrument, it is recommended that this operation be performed after each use.

If the lenses become so heavily contaminated that using the air purge pump is ineffective, the instrument should be returned to Casella CEL for cleaning and re-calibration. Note that the Warranty does not extend to cleaning or general servicing of the instrument.

5.3 Fault Finding Tips

The MicroDust *pro* contains no user serviceable components. Repairs should be performed only by authorised personnel.

If an electrical fault is found, or a fault persists after carrying out the recommendations in the service hint, return the instrument to Casella CEL Ltd for repair.

Fault Symptom	Possible Cause	Service Hint
Instrument does not switch ON	Battery discharged, or failing to charge. Confirm charger indicator is lit	Recharge or replace battery if necessary. Use external power supply.
Probe always reads zero	Fault with Infrared transmitter or receiver.	Check the probe connection.
Continuous "over range" indication	Optical misalignment due to mechanical shock. Excessive contamination.	Return the instrument to the service department for optical alignment, cleaning and re-calibration.
Unstable or drifting zero indication with probe cover on	Sample chamber may be contaminated by dust or fibre.	Use the bellows pump to purge the probe with clean air prior to setting zero. The probe cover should be open slightly when purging, to allow venting of purge air.
Probe contamination message is displayed	Excessive contamination of probe or optical misalignment due to mechanical shock.	Purge the probe with clean air from the bellows pump.

6. SPECIFICATION

6.1 Instrument Specification

Measurement

Sensing technique:	Forward light scattering (12 to 20°) using 880 nm infra red source.
Measuring Range:	0.001 - 2,500 mg/m ³ over four ranges 0 - 2.5, 0 - 25, 0 - 250 and 0 - 2500 mg/m ³ . Active range may be fixed or auto ranging.
Resolution:	0.001 mg/m ³ .
Zero stability:	Typically <2 µg/ m ³ /°C.
Span Stability:	±0.7% of reading /°C.
Operating Temp Range:	0 to 50°C (non condensing).
Storage Temp Range:	-20 to +55°C (non condensing).

Power Supply

Instrument Power Consumption:	Approx. 100 mA.
Battery:	4 x AA / MN1500 cells Alkaline or rechargeable Nickel Cadmium.
Operating run time:	Alkaline Batteries (2700 mAh), typically >20 hours, Rechargeable NiCd cells (950 mAh), typically >9 hours
Battery Charging	Internal NiCd fast charger circuitry. Charge termination based on Negative delta V detection with additional time-out protection. Charger must be disabled for dry cell operation.
Charge Rate	Fast charge rate 450 mA, Standby charge rate 55 mA approx.
Power adapter (-PC18)	Universal with input voltage range 100 - 240 VAC, 47 - 63 Hz. Output 12 VDC at 0.8 A. Supplied with connectors suitable for USA, UK, European and Australian mains outlet sockets. The instrument may be powered continuously from the external power adapter.

Specification

*MICRODUST pro Aerosol Monitoring System &
WINDUST pro Application Software - Handbook*

Physical

Display:	128 x 64 pixel LCD Graphics panel with backlight.
Keypad:	7 key tactile membrane
Weight:	Instrument with probe: 0.97 kg. Complete kit in carry case: 4.5 kg
Dimensions:	Instrument H x W x D: 245 x 95 x 50 mm. Probe: 35 mm \varnothing x 290 mm total length. Carrying case H x W x D: 135 x 490 x 370 mm.

Displayed Values

Current Concentration	Represents the rolling average of instantaneous dust concentration over a user selectable time period from 1 to 60 sec.
Time weighted average	Representing the average value since switch on or reset.
Max Value	Representing the maximum instantaneous value since switch on or reset. (Instantaneous values are updated every second)
Scrolling Graph	Graph mode provides unique indication of variations in dust concentration. Selectable timebase periods of 100 sec, 200 sec, 15 mins, 60 mins, Y-axis range may be autoranging or fixed.
Factory calibration	Factory calibrated using traceable isokinetic techniques and ISO 12103-1 A2 Fine test dust (Arizona Road Dust equivalent). Four user defined calibration settings to suit specific dust types or monitoring applications.
Routine Calibration	Easy software calibration for Zero and Span setting. Confirmation of Factory calibration point using optical reference filter.

Data Logger

Internal memory:	64 k EEPROM providing over 15,700 data points.
Example capacities:	Logging every 5 seconds: 21 hours 48 mins, Logging every minute: 10 days 21 hours
Logger Interval:	Adjustable from 2 to 600 seconds.

Recorded Values:	Average concentration over logging interval. Maximum and Average values for the entire logging period are saved at the end of each logging run.
Serial Interface:	RS232 up to 38,400 baud. IrDa (Future expansion).
Analogue output:	0 - 2.5 V DC FSD, 500 Ω output impedance.
Digital output (only when Alarm is selected):	2.5 V Alarm On, 0 V Alarm Off.

6.2 Maintenance

Factory cleaning required annually, depending on measurement conditions.

6.3 WinDust pro, PC Based Application Software

Provides a friendly graphical interface for instrument configuration, data download and graphical report presentation.

Operating System	M.S Windows 95/98/ME/2000 and NT compatible, Pentium or better processor, Requires RS232 serial port, 8 MB RAM, Hard drive with at least 4 MB free space, 3 ¹ / ₂ " (1.4 MB) floppy disk drive, VGA colour graphics, Printer - optional.
------------------	---

6.4 Spare Parts

-B141	NiCad Rechargeable Battery (4 required).
-------	--

6.5 Optional Accessories

176086B	Car Charging Lead,
180043B	10 m Extension Cable.

6.6 CE Compliance

The MicroDust pro complies with the EMC Directive 89/336/EEC of the European Union. It has been tested according to the standard delivery schedule and complies with the following standards.

Specification

*MICRODUST pro Aerosol Monitoring System &
WINDUST pro Application Software - Handbook*

EN 50081-1 : 1992, EN 50081-2 : 1993:

Generic emission standards for
residential, commercial, light industry and
industrial environments.

EN 50082-1 : 1992, EN 50082-2 : 1995:

Generic immunity standards (for both RF
fields and electrostatic discharge) for
residential, commercial, light industry and
industrial environments.

EN 61000-4-2 : 1995, IEC 61000-4-2 : 1995:

Electromagnetic compatability (EMC).
Testing and measurement techniques.
Electrostatic discharge immunity test.

APPENDIX A

Microdust pro Remote Control Command Set

A.1 Introduction

The Casella Microdust *pro* Real Time Dust Monitor (RDM) can be remotely controlled from a PC suitably equipped with a simple terminal emulation program such as that found in many operating system software packages.

Connection between the PC and the RDM is achieved using the cable that was originally supplied with each RDM when first delivered. Connect the 6-way mini DIN plug to the socket on the bottom of the RDM and the 9-way plug into a convenient RS232 communication port on the rear of the PC. If a special cable needs to be manufactured please consult Chapter 1 for details of the pin assignments given in Figure 5 and Table 1.

Communication takes place with a variable Baud rate from 600 to 38400 bps, 8 data bits, 1 stop bit no parity over RS232 levels.

A number of single letter commands are given below to action key functions while mimicking the action of the keypad buttons will allow the whole of the instrument's menu structure to be accessed as if the user was pressing the keypad directly.

The following commands are described:

Command 'B':	Upload bitmap screen to instrument
Command 'C':	Clear bitmap
Command 'I':	Interrogate target
Command 'R':	Set instrument id and time date
Command 'T':	Download records stored
Command 'X':	Start real time output
Command 'Z':	Stop real time output
Keypad User interface commands.	

A.2 Individual Commands

Command 'X': - Start real time output

E.g. 'X'

The instrument will transmit the average dust concentration displayed on the instrument, and will be updated very second.

i.e. "2.87[CR][LF]"
"2.55[CR][LF]"
"2.60[CR][LF]" ; etc.

Command 'Z': - Stop real time output

E.g. 'Z' ; This will inhibit the real-time data output.

Command 'I': - Interrogate target

E.g. 'I'

The instrument will transmit a comma-delimited string containing two ID strings. The first is the number of records stored in the loggers and the second is the firmware version of the instrument.

i.e. "CasellaCEL,(01234) 844100,K, 11,80-176087A-XX,[CR][LF]"

(This information can be viewed in the status screen of the instrument.)

Command 'T': - Download records stored

E.g. 'T' ; Download all records stored in the instrument

i.e. Log close, 28/07/03,12:13:48, 129.396, 129.445,28/07/03,12:13:42,
0 [CR][LF]
28/07/03,12:13:48, 129.361, 1 [CR][LF]
28/07/03,12:13:46, 129.387, 2 [CR][LF]
28/07/03,12:13:44, 129.439, 3 [CR][LF]
Log close, 28/07/03,12:11:30, 240.920, 240.947,28/07/03,12:11:22,
4 [CR][LF]
28/07/03,12:11:30, 240.882, 5 [CR][LF]
28/07/03,12:11:28, 240.909, 6 [CR][LF]
28/07/03,12:11:26, 240.897, 7 [CR][LF]
28/07/03,12:11:24, 240.920, 8 [CR][LF]
28/07/03,12:11:22, 240.937, 9 [CR][LF]
28/07/03,12:11:20, 240.935, 10 [CR][LF]
28/07/03,12:11:18, 240.943, 11 [CR][LF]
28/07/03,12:11:16, 240.935, 12 [CR][LF]

Command 'R': - Set instrument id and time date

This command will enable the user to remotely set time/date and two ID string. All records stored in the instrument will be erased.

(This information can be view in the status screen of the instrument).

E.g. 'R' ; wait until 'D' received then transmit data.

"CasellaCEL,(01234)844100,K,28/07/03,12:30[CR][LF]"

NOTE: ID max string length 16 bytes each. Date format is dd/mm/yy. Time format is hh:mm in 24 hour format.

Command 'B': - Upload bitmap screen to instrument

E.g. 'B' ; wait until 'D' received then transmit 1024 bytes.

First byte will form the top left column of the display.

Command 'C': - Clear bitmap

E.g. 'C' ; To restore the start up bitmap to the default.

User interface Commands

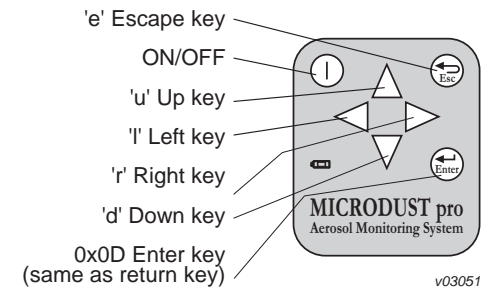

Keypad of the Microdust Pro RDM

Display

'i' // Screen dump

The screen dump from the instrument should be requested not more rapidly than once every two seconds to allow all the data to be transferred successfully.

Data format is binary data and first byte is top left column of display.

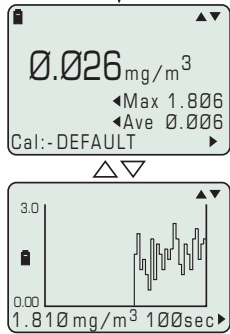

**** MAIN MENU ****
 View Graph
 View Measurement
 MicroDust Status
 Logger
 Calibration
 Configuration

14, Mar 00 10:25
 Battery: 4.9 Volts
 Memory: 2% Full
 Runs: 1/32
 Version: NN-NN-N
 User: Name and Details

2 12 15:05:32
 0.026 mg/m³
 Max 1.806
 Ave 0.006
 Cal: -DEFAULT

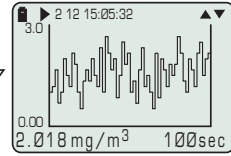

DUST INPUT RANGE
 Range: 2.500 mg/m³
 Graph: Lock Range

LOGGER
 Start Logger
 View Runs
 Config Logger

CONFIG LOGGER
 Intervals: 001 Sec
 Log time: 000 04:18:15
 Mode: Stop when full
 Clear Memory: NO

Run Number: 01/02
 Start Date: 08 Mar 00
 Time: 16:10:57
 Duration: 01:29:44
 Ave Value: 4.37
 Max Value: 25.00

BACK LIGHT ON TIME
 Enable: Light, OFF
 Duration: 00

AVERAGING TIME
 Average: 1 Sec
 Analogue: Ave
 Alarm Status: Off
 Alarm Level: 0.500
 Alarm Reset: Keypad

CALIBRATION
 Set Zero
 Set Span
 Set Optical Filter
 User Dust Types
 Restore Default CAL

0.001 mg/m³
 Purge Probe until stable.
 Press ← to Zero

CONFIGURATION
 Measuring Range
 Averaging Time
 Back Light
 Time & Date
 Language
 Serial Comm's

TIME & DATE
 Wed 14 March 00
 14:59:26
 Set Time
 Set Date

SET TIME
 Hours: 15
 Minutes: 01
 Seconds: 32

WARNING
 Pressing ← Loads basic calibration constants.
 Use Optical filter for optimum accuracy.
 ← Cancel

SET OPTICAL FILTER
 25.00
 Set value shown on Calibration filter

25.00 mg/m³
 Insert Calibration Filter and Press ←
 Filter Ref; 25.0

SELECT LANGUAGE
 English
 Française
 Deutsch
 Italiano
 Español

SET DATE
 Day: Wednesday
 Date: 14
 Month: March
 Year: 00

SET DUST PARAMETERS
 Dust: SITE 4
 Factor: 1.000
 Set Name:
 Set Factor:

Serial Comms
 Port: RS232
 Baud Rate: 9600
 Data Bits: 8
 Stop Bits: 1
 Parity: None

SET CORRECTION FACTOR
 1.000
 Press ← to save and exit.

SET DUST NAME
 [SITE 4]
 Press ← to save and exit.

Options introduced at Firmware Version 06.

MICRODUST pro Menu Structure