

Honeywell

ToxiPro[®]

Single Gas Detector

Reference Manual



Honeywell Analytics
651 South Main Street
Middletown, CT 06457
(800) 711-6776
(860) 344-1079
Fax (860) 344-1068
Part number 13-264-N3
Version 1.30
03-June-2011

WARNING

**THE TOXIPRO[®]-NGSG PERSONAL PORTABLE GAS DETECTORS
HAVE BEEN DESIGNED FOR THE DETECTION AND MEASUREMENT
OF POTENTIALLY HAZARDOUS ATMOSPHERIC CONDITIONS.**

**IN ORDER TO ASSURE THAT THE USER IS PROPERLY WARNED OF
POTENTIALLY DANGEROUS ATMOSPHERIC CONDITIONS, IT IS
ESSENTIAL THAT THE INSTRUCTIONS IN THIS REFERENCE
MANUAL BE READ, FULLY UNDERSTOOD, AND FOLLOWED.**

**ToxiPro[®]-NGSG Reference Manual
Honeywell Analytics Part Number 13-264-N3
Version 1.30
Copyright 2011
by
Honeywell Analytics, Inc
Middletown, Connecticut 06457**

All rights reserved.

**No page or part of this operation manual may be reproduced in
any form without written permission of the copyright owner
shown above.**

Honeywell Analytics reserves the right to correct typographical errors.

Table of Contents

Operating Temperature Range	3
Certifications	3
Warnings and Cautions	4
A. Signal Words	4
B. Warnings	4
1. Overview	5
1.1 Methods of sampling	5
1.2 Sensors	5
1.2.1 ToxiPro sensor ranges	5
1.2.2 ToxiPro O ₂ sensor ranges	5
1.2.3 ToxiPro O ₂ warm-up phase	5
1.3 Alarm and warning logic	5
1.3.1 Gas alarms	5
1.3.2 Calibration and bump test due notices	5
1.3.3 Battery replacement Warning	5
1.3.4 Low battery alarms	6
1.3.5 Missing sensor during startup	6
1.3.6 Corrupt memory	6
1.3.7 Vibrating Alarm Error	6
1.3.8 Heartbeat Feature	6
1.4 Functions	6
1.4.1 Security beep	6
1.4.2 Latching alarms	6
1.4.3 Enhanced Latching Alarm	6
1.4.4 Silence warning alarms	6
1.5 IQ Dock Compatibility	6
1.6 Design components	7
1.7 Standard accessories	7
1.8 Value pack kits	7
2. Field Operation	7
2.1 Turning the ToxiPro on	7
2.1.1 Calibration due lockout	8
2.2 Backlight	8
2.3 Functions	8
2.4 Calibration and bump test due notices	9
2.5 Low battery alarms	9
2.6 Sensor Over Range	9
2.7 Turning the ToxiPro off	10
2.8 Always On Mode	10
2.8.1 Turning Off in Always On Mode	10
2.9 Sampling	10
2.9.1 Sample draw kit usage	11
3. Calibration	11
3.1 Verification of accuracy	11
3.1.1 Verifying accuracy and response: ToxiPro O ₂	11
3.1.2 Verifying accuracy: ToxiPro with toxic gas sensor	11
3.2 Effect of contaminants on ToxiPro sensors	12
3.2.1 Effects of contaminants on O ₂ sensors	12
3.2.2 Effects of contaminants on toxic gas sensors	12
3.3 Fresh air/zero calibration	12
3.4 Functional (bump) testing (toxic sensor versions)	13
3.5 Span Calibration (toxic sensor versions)	13
3.6 Failure to calibrate	14
3.6.1 Fresh air/zero calibration failure	14
3.6.1.1 Causes of fresh air/zero calibration failures	14
3.6.1.2 Forced fresh air/zero calibration	14

3.6.2	Span calibration failure	14
3.6.2.1	Sensor out of range (no CAL).....	14
3.6.2.2	Causes for span cal failure	14
3.7	Fresh air/zero calibration in a contaminated atmosphere	15
4.	Maintenance	15
4.1	Replacing batteries.....	15
4.2	Replacing sensors	16
4.3	Proper Cleaning	16
4.4	Storage.....	16
5.	PC-Instrument Communications	16
5.1	Event logging.....	16
5.2	Instrument firmware upgrades.....	17
5.3	Initiating communications	17
6.	Exploded view and basic parts list.....	17
Appendices.....		18
Appendix A:	Sensor Cross-Sensitivity Chart	18
Appendix B:	Replacement Sensor List.....	18
Appendix C:	Calibration Frequency Recommendation	19
Honeywell Analytics Warranty Gas Detection Products		20

Operating Temperature Range

⚠WARNING The safe operating temperature range of the gas detector is printed on the back label of the instrument. Use of Honeywell Analytics Gas Detectors outside of the instrument’s specified operating temperature range may result in inaccurate and potentially dangerous readings.

Certifications

The ToxiPro[®]-NGSG carries the following certifications:

UL and c-UL, Class I, Division 1, Groups A,B,C,D, Temp Code T4.

UL Class II, Division 1, Groups E,F,G

ATEX Certification:

II 1 G Ex ia IIC T4

UL International DEMKO A/S 09 ATEX 0823124

IECEX Ex ia IIC T4 Ga

Warnings and Cautions

A. Signal Words

The following signal words, as defined by ANSI Z535.4-1998, are used in the ToxiPro-NGSG Operator's Guide.

⚠ DANGER indicates an imminently hazardous situation which, if not avoided, will result in death or serious injury.

⚠ WARNING indicates a potentially hazardous situation which, if not avoided, could result in death or serious injury.

⚠ CAUTION indicates a potentially hazardous situation, which if not avoided, may result in moderate or minor injury.

CAUTION used without the safety alert symbol indicates a potentially hazardous situation which, if not avoided, may result in property damage.

B. Warnings

1. **⚠ WARNING** ToxiPro personal, portable gas detectors have been designed for the detection of either oxygen deficiencies or specific toxic gas accumulations. An alarm condition indicates the presence of a potentially life-threatening hazard and should be taken very seriously.
2. **⚠ WARNING** In the event of an alarm condition it is important to follow established procedures. The safest course of action is to immediately leave the affected area, and to return only after further testing determines that the area is once again safe for entry. Failure to immediately leave the area may result in serious injury or death.
3. **⚠ WARNING** Use only Panasonic #CR2 in the ToxiPro.
4. **⚠ WARNING** The accuracy of ToxiPro instruments equipped with toxic gas sensors should be checked periodically with known concentration calibration gas. Failure to check accuracy can lead to inaccurate and potentially dangerous readings. The ToxiPro O₂ should be periodically calibrated in fresh air.
5. **⚠ WARNING** A sensor that cannot be calibrated or is found to be out of tolerance must be replaced immediately. An instrument equipped with a toxic gas sensor that fails calibration may not be used until testing with known concentration test gas determines that accuracy has been restored, and the instrument is once again fit for use. Instruments equipped with an oxygen sensor that fail calibration may not be used until testing with fresh air determines that accuracy has been restored and the instrument is once again fit for use.
6. **⚠ WARNING** Do not reset the calibration gas concentration setpoints in the ToxiPro unless the concentrations of your calibration gas differ from the concentrations of the calibration gas that is normally supplied by Honeywell Analytics for use in calibrating the ToxiPro.
7. **⚠ WARNING** Use of non-standard calibration gas and/or calibration kit components when calibrating the ToxiPro can lead to dangerously inaccurate readings and may void the standard Honeywell Analytics warranty.
Honeywell Analytics offers calibration kits and long-lasting cylinders of test gas specifically developed for easy calibration. Customers are strongly urged to use only Honeywell Analytics calibration materials when calibrating the ToxiPro.
8. **⚠ WARNING** Substitution of components may impair intrinsic safety.
9. **⚠ WARNING** For safety reasons the ToxiPro must be operated by qualified personnel only. Read, understand and follow the directions set forth in this reference manual before operating the ToxiPro.
10. **⚠ WARNING** The ToxiPro has been tested for intrinsic safety in Explosive Gas/AIR (max. 21.0% O₂).

1. Overview

The ToxiPro is a single sensor gas detector that can be configured to detect either oxygen (O₂) or one of a variety of toxic gases. The ToxiPro's sensor type is shown on the front of the instrument and is also shown on the display during the start up sequence. The ToxiPro includes numerous features designed to meet specific user requirements.

1.1 Methods of sampling

The ToxiPro may be used in diffusion mode, or with the manual sample draw kit that is available separately. In either mode, the atmosphere must reach the sensor for the instrument to register a reading. In diffusion mode, the atmosphere reaches the sensor by diffusing through the sensor port on the front of the instrument. Normal air movements are enough to carry the sample to the sensor. During remote sampling, the gas sample is drawn into the sensor compartment through the probe assembly and a length of tubing. **See section 2.9 for more details on sampling the atmosphere.**

1.2 Sensors

All versions of the ToxiPro except the O₂ model use an electrochemical toxic gas sensor. The ToxiPro O₂ uses a galvanic oxygen sensor. Both types of sensor have been designed to minimize the effects of common interfering gases. These sensors provide accurate, dependable readings for gases commonly encountered in industrial applications.

A sensor cross sensitivity chart is provided in Appendix A at the back of this manual.

1.2.1 ToxiPro sensor ranges

Specific toxic sensor ranges and resolutions are provided in the sensor replacement chart in Appendix B.

1.2.2 ToxiPro O₂ sensor ranges

The oxygen sensor used in the ToxiPro O₂ has a range of 0-30% by volume.

1.2.3 ToxiPro O₂ warm-up phase

The ToxiPro O₂ requires a one-time, 15-minute warm-up phase prior to initial activation. See section 2.1 for further details.

1.3 Alarm and warning logic

1.3.1 Gas alarms

ToxiPro gas alarms are user-adjustable and may be set anywhere within the range of the specific sensor. When an alarm set point is exceeded a loud audible alarm sounds. In the

warning state the LED's will flash, yellow. In the danger state the LED's will flash, red.

Two oxygen alarm set points have been provided for ToxiPro O₂ instruments. The danger alarm is sounded for oxygen deficiency and the warning alarm is sounded for oxygen enrichment.

ToxiPro instruments equipped with a toxic gas sensor have up to four alarm set points: Warning, Danger, Custom, TWA (Time Weighted Average) (if enabled) and STEL (Short Term Exposure Limit) (if enabled). The custom alarm level can be set to a level greater than/equal to the danger alarm level for toxic sensors and less than/equal to danger level for oxygen sensors using the IQ System software. The custom alarm is a latching alarm. The custom alarm looks and sounds similar to the DANGER alarm but, with the warning symbol turned on and the DANGER icon not being set. If the custom alarm level has been reached then the alarm can only be silenced by putting the instrument in the dock (successful IrDA connection) or successful connection to BioTrak. If the custom alarm value is zero then the custom alarm is disabled and "OFF" will appear on the instrument's LCD during the startup sequence. If the danger alarm has been disabled then the custom alarm is also disabled.

Note: In the standard ToxiPro configuration with toxic gas sensors, the STEL and TWA alarms are not enabled. The STEL and TWA alarms may be enabled at the factory or through BioTrak software. Call Honeywell Analytics for more details.

1.3.2 Calibration and bump test due notices

The ToxiPro includes bump test and calibration due notices.

For more information on the calibration due notices, see section 2.4 below.

1.3.3 Battery replacement Warning

If a new battery has been installed or the existing battery was removed and replaced the ToxiPro will show "F 0" on the display and will beep 6 times upon startup. It will then go into the set time/date mode.

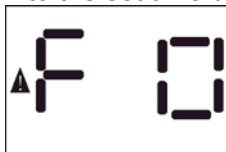

1.3.4 Low battery alarms

The ToxiPro is designed with two battery warning alarms that are activated when the battery voltage is reduced to specific levels.

For more details on the battery alarm, see section 2.5 below.

1.3.5 Missing sensor during startup



If the ToxiPro fails to detect a sensor during startup, it will show “F 1” with the caution symbol and then shut itself off. For more details, see section 2.1.

1.3.6 Corrupt memory

The ToxiPro continuously monitors its onboard memory. If the instrument determines that the memory is corrupt, it will display “F 4” and proceed to shut itself off.

If “F 4” is displayed, contact Honeywell Analytics for further details.

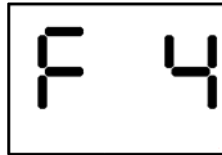

1.3.7 Vibrating Alarm Error

If the vibrating alarm fails “F 6” will be shown on the display. Contact Honeywell Analytics for further details.

1.3.8 Heartbeat Feature

A blinking heart is an active indicator, notifying the user that the instrument is operating normally.



1.4 Functions

1.4.1 Security beep

The ToxiPro includes a security beep that can be enabled or disabled with BioTrak software through the PC’s IrDA port. If the security beep is enabled, the ToxiPro will emit a short beep coupled with an LED flash at a specific interval to remind the user that the instrument is active.

1.4.2 Latching alarms

The ToxiPro includes latching alarms that can be enabled or disabled with BioTrak software through the PC’s IrDA port. With the alarm latch enabled, the audible and visible alarms will continue to sound even after the atmospheric hazard has cleared. To turn the

alarm off once the hazard is no longer present, simply press the MODE button.

1.4.3 Enhanced Latching Alarm

Note: V9.20 or greater ToxiPro firmware and V8.00 or greater is required of all IQ System software to support the Enhanced Latching Alarm.

The enhanced latching capability can be enabled for the danger alarm using an IQ System template and apply the template in ToxiPro IQ Express.

The user can specify the duration for latching of the Danger alarm. When the instrument goes into the danger alarm for greater than or equal to the user defined duration for latching then the alarm is latched.

When the alarm is latched and if the gas level goes below the alarm level, the audible and visual alarms will continued.

If alarm latching is enabled and the instrument is in alarm for less than the latching duration, the alarm will not latch when the gas level drops below the alarm level.

Latch Acknowledgement

A latched alarm latch can be acknowledged by two methods. The first is either by mode press or inserting the instrument into the dock. The second is by dock insertion only. The method is selectable in the IQ System template.

Note: For more information on creating and assigning templates, please refer to the Database Manager Reference manual.

1.4.4 Silence warning alarms

The ToxiPro’s audible and vibrating (if so equipped) alarms can be turned off during an alarm condition by pressing the MODE button if this function has been enabled with BioTrak software. The visual warning alarm light and readings will continue to indicate the alarm.

1.5 IQ Dock Compatibility

The ToxiPro must be equipped with instrument firmware version 4.30 or higher to be compatible with the IQ Express Docking Station. The IQ Express Dock is an automatic calibration station coupled with a data management system. The IQ Express Dock must be equipped with firmware version 6.53 or higher. Instrument firmware in the ToxiPro may be upgraded at any time. **See section 5.2 below for details on software upgrades.**

1.6 Design components

Case: The instrument is enclosed in a solid PC (polycarbonate) case with TPE (rubber) overmold.

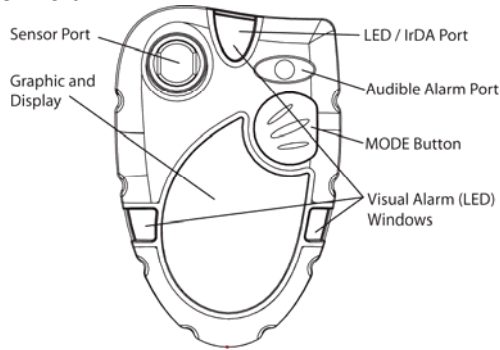

Figure 1: Exterior front view.

Front face: The front face of the instrument houses the LCD display, MODE button, sensor port, LED alarm and audible alarm port.

LCD display: The liquid crystal display (LCD) shows gas readings, messages and other information. A built-in, manually-activated backlight allows the display to be read even in low light conditions.

LED / IrDA port: The LED also functions as the IrDA port.

MODE button: The large push-button on the front of the instrument is called the MODE button. The MODE button is used to turn the ToxiPro on and off, to turn on the backlight, to view the MAX, STEL (if enabled) and TWA (if enabled) screens and to initiate the automatic calibration sequences.

Sensor port: The sensor port is located at the upper left corner of the instrument. A filter prevents unwanted contaminants from entering the sensor.

Audible alarm port: A cylindrical resonating chamber contains the loud audible alarm.

Visual alarm (LED) Windows: A bright LED (Light-Emitting Diode) alarm light provides a visual indication of the alarm state.

Belt Clip: The belt clip attaches to the bottom surface of the instrument.

1.7 Standard accessories

Standard accessories with every ToxiPro include installed sensor and lithium battery, reference manual and calibration/sample draw adapter.

Optional accessories include manual sample draw kit (hand-aspirated), vibrating alarm, Datalogger Upgrade and BioTrak software kit.

1.8 Value pack kits

ToxiPro value packs include all standard accessories, plus calibration fittings, 34-liter cylinder of calibration gas, and fixed flow rate regulator in a foam-lined, hard-shell carrying case.

2. Field Operation

Field operation of the ToxiPro is controlled entirely through the MODE button, which is located on the front of the instrument.

The MODE button is used to turn the ToxiPro on and off, to turn on the backlight, to access MAX, STEL (if enabled) and TWA (if enabled) gas readings for the current session and to initiate calibration.

2.1 Turning the ToxiPro on

The ToxiPro is effectively disabled when it leaves the Honeywell Analytics factory. Upon arrival, the ToxiPro's display will be blank. The ToxiPro O₂ will show the negated horn icon.

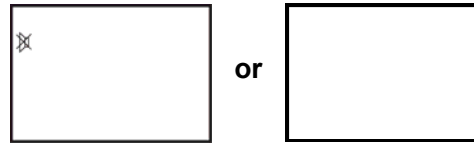

To initialize the instrument, press the MODE button for 5 seconds. ToxiPro O₂ models will proceed with a 15-minute countdown while the oxygen sensor stabilizes.

Note: The 15-minute sensor warm-up period is only necessary for the initial start-up of ToxiPro O₂ models.

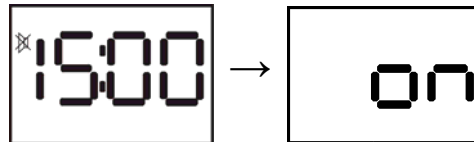

When the ToxiPro O₂ warm-up period concludes, the screen will be completely blank. ToxiPro models equipped with a toxic gas sensor do not require an initial warm up period.



With the blank screen shown, press and hold the MODE button for 5 seconds to initiate the start-up sequence.

At start-up, the ToxiPro will automatically go through a basic electronic self-test sequence that will take approximately thirty seconds. During the self-test sequence, all sections of the display will be lit, the display backlight will momentarily turn on and the audible alarm will "chirp".

If the instrument fails to detect the sensor during startup, "F 1" will be displayed with the caution symbol following the display test screen. If "F 1" is shown, the instrument will automatically shut down in approximately 5 seconds. See Section 4.2 of this manual for instructions on accessing the sensor compartment.

Once the ToxiPro recognizes the sensor, it will display the software version using two screens.

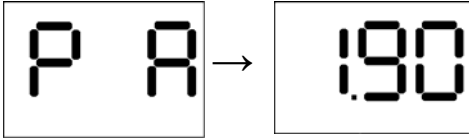

The serial number screens will then be shown: Note that the 9 digit serial number can not fit on a single screen, so it is shown on three screens. In this case, the instrument serial number is 481098190.

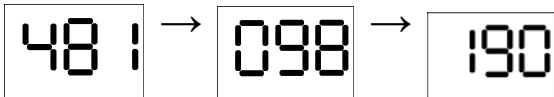

Datalogging versions will then show the “dL” screen.

Once the sensor is recognized, the instrument will display the sensor type. The warning alarm level will then be displayed, followed by the danger alarm level. During the display of the warning alarm level, the LED alarm light will be flashed twice and the audible warning alarm will be sounded twice.

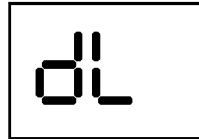

During the display of the danger alarm level, the LED visual alarm will be flashed twice and the audible danger alarm will be sounded twice. The frequency of the audible danger alarm is higher than the frequency of the audible warning alarm. The custom alarm if enabled is displayed similar to the danger alarm, but the LCD has the triangular warning symbol without the Danger or Warning symbol.

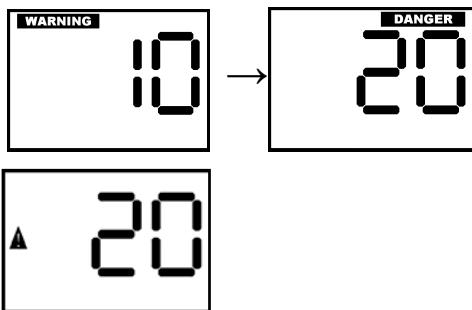
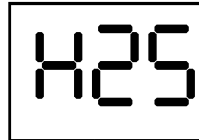

For ToxiPro instruments with a toxic sensor and with the STEL and TWA alarms enabled, the ToxiPro will briefly show the STEL and TWA alarm levels.

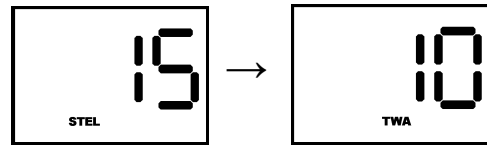

If the calibration due reminder is enabled and calibration is due, the following screens will be shown.

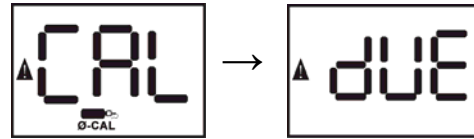

Press the MODE button to acknowledge the calibration due reminder. If the instrument shuts off when the MODE button is pressed with “cal due shown”, then the ToxiPro is configured with calibration due lockout enabled.

See section 2.1.1 below for more details on the calibration due lockout function.

The Calibration Due Reminder and Lockout functions may be enabled or disabled with BioTrak Software.

The current gas readings screen will then be shown. Toxic sensor models should show 0 if the instrument is located in fresh air. Oxygen sensor models should show 20.9 in fresh air. In normal operation the screen alternates between gas reading and sensor type.

2.1.1 Calibration due lockout

When the ToxiPro’s calibration due lockout function is enabled and calibration is due, the calibration due warning will be shown at instrument start up and can not be bypassed. The instrument must be calibrated immediately before it will show any gas readings. The calibration may be performed manually, or by placing it in an IQ Express Dock. Upon successful calibration, the ToxiPro will proceed to the current gas readings screen.

The calibration due lockout function can be enabled or disabled with BioTrak software.

2.2 Backlight

The ToxiPro includes a backlight that is automatically turned on during an alarm condition. The backlight can also be manually activated while the current gas reading is displayed by pressing the MODE button once. When manually activated, the backlight will automatically turn itself off in about twenty seconds. If activated by an alarm condition, the backlight will remain on until the instrument is no longer in alarm.

2.3 Functions

From the current gas reading screen, press the MODE button once to



activate the backlight. Press MODE again to scroll through the screen options. Once the backlight has been lit, press MODE once more to view the MAX gas values screen. The MAX figure represents the highest gas value reading that has been recorded by the instrument during the current operating session. ToxiPro O₂ models will sequentially display both the highest and the lowest readings that have been recorded by the instrument in the current operating session.

From the MAX screen, press the MODE button to view the time screen. A dot below the colon between the hours and the minutes digits indicates afternoon/evening hours (pm).



10:45 am

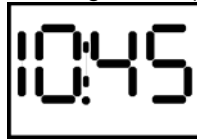

10:45 pm

If the STEL (Short Term Exposure Limit) alarm is enabled, press the MODE button once to view the STEL reading. The STEL value displayed represents the average value of the instrument readings for the target gas for the most recently completed 15 minutes of operation.

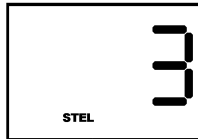

If the TWA (Time Weighted Average) alarm is enabled, press the MODE button once more to view the current TWA value. TWA values are calculated by taking the sum of the instrument readings for the target gas for the current operating session in terms of parts-per-million-hours and dividing by an eight-hour period.

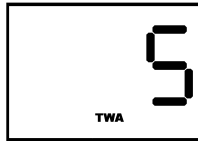

Note: Due to the nature of the TWA calculation, the TWA value can accumulate over time and may cause the instrument to go into alarm. Honeywell Analytix recommends resetting the TWA value at the beginning of any work shift by turning off the instrument and then turning it back on again.

Press the MODE button again to return to the current gas readings screen.

2.4 Calibration and bump test due notices



When the calibration due notice is enabled and the ToxiPro is due for fresh air calibration "0-CAL" will be displayed at the bottom of the current gas readings

screen along with the triangular warning symbol.



When the calibration due notice is enabled and the ToxiPro is due for span calibration the calibration bottle icon will be displayed at the bottom of the current gas readings screen along with the warning symbol.



The bump test due notice is designed for instruments that are processed in an IQ Express Dock. When the bump test due notice is enabled and the ToxiPro is due for a bump test, the calibration bottle icon will be displayed at the bottom of the current gas readings screen without the triangular warning symbol.

Note: If an IQ Express Dock is unavailable, a span calibration will also reset the bump test due notice.

2.5 Low battery alarms



When there are less than 7 days of battery life remaining, the low battery icon will be lit.



When there are less than 8 hours of battery life remaining, the triangular warning symbol on the LCD will also be shown.



When the battery reaches a level where it can no longer power the instrument, the ToxiPro will sound a low battery alarm for two minutes while displaying the danger, caution and battery icons. Press MODE to turn the instrument off. The battery must be replaced before the instrument can be used again. If the MODE button is not pressed, the instrument will remain in alarm for as long as it can before shutting itself off.

2.6 Sensor Over Range

The ToxiPro will go into alarm if a sensor is exposed to a concentration of gas that exceeds its established range. In the case of an H₂S reading that exceeds 200 PPM, the ToxiPro will go into the danger alarm state and the display will show “OL” in place of the sensor reading.



After an over range condition occurs the unit must be calibrated under controlled conditions. When an over range condition occurs, the calibration indicators are automatically activated.

2.7 Turning the ToxiPro off

To turn the ToxiPro off, press and hold the MODE button down until the instrument chirps three times and OFF is displayed.



Once OFF is displayed, release the MODE button. The instrument has been successfully turned off when the display goes blank.

If Always On Mode is enabled see section 2.8.1 for instructions for turning off the ToxiPro.

2.8 Always On Mode

The ToxiPro may be configured so that it may not be turned off with the MODE button. In Always On Mode, the MODE button is used to reset the MAX, STEL and TWA calculations. Press and hold the MODE button until the instrument chirps three times and “on” is displayed.



After the “on” screen, the ToxiPro will proceed through the standard startup sequence until the current gas readings screen is shown. MAX, STEL and TWA calculations will be reset.

Always On Mode may be enabled or disabled with BioTrak software.

Note: The ToxiPro must be turned off to replace the battery. See section 2.8.1.

2.8.1 Turning Off in Always On Mode

BioTrak software must be used to turn the ToxiPro off when it is in Always on Mode. BioTrak is available at:

<http://www.biodownloads.com>

1. Open BioTrak and select ToxiPro.

2. Select “Configure” in the software.
3. Hold the MODE button down for about 10 seconds until IrDA is shown and establish the connection with the PC.
4. The Never Turn Off option appears at the bottom left of every page in the configuration window. Click the Turn Off button.

2.9 Sampling

The ToxiPro may be used in either diffusion or sample-draw mode. In either mode, the gas sample must enter the sensor compartment for the instrument to register a gas reading.

In diffusion mode, the atmosphere reaches the sensor by diffusing through the sensor port on the front of the instrument. Normal air movements are enough to carry the sample to the sensor. The sensor reacts quickly to changes in the concentration of the gas being measured.

It is also possible to use the ToxiPro to sample remote locations with the hand-aspirated sample-draw kit that is available separately. During remote sampling, the gas sample is drawn into the sensor compartment through the probe assembly and a length of tubing.

⚠WARNING The ToxiPro and manual sample draw kit are delivered with polyester urethane (fuel-resistant) tubing part number 53-001. This material is completely compatible with the toxic gases CO and H₂S. When using the ToxiPro and sample draw kit to sample with any of the gas types and tubing lengths listed in the chart below, FEP-lined tubing (part number 53-036) should be used.

Gas Type	Tubing Length
CL ₂ , CLO ₂	Up to 10 ft/3m Max.
HCN	Up to 100 ft/30m Max.
SO ₂ , NO ₂ , PH ₃ , NH ₃	> 10 ft/3m up to 100 ft/30m Max.

Standard polyester urethane (fuel-resistant) tubing (part number 53-001) can be used otherwise. Use of other types of tubing, or beyond recommended length(s), may cause inaccurate and potentially dangerous readings that could result in serious injury or death.

2.9.1 Sample draw kit usage

1. Connect the shorter section of tubing from the squeeze bulb to the sample draw adapter. Then connect the longer section of tubing from the squeeze bulb to the sample probe.
2. Slide the sample draw adapter into the sensor port on the ToxiPro and secure it.
3. Cover the end of the sample draw probe assembly with a finger, and squeeze the aspirator bulb. If there are no leaks in the sample draw kit components, the bulb should stay deflated for a few seconds.
4. Insert the end of the sample probe into the location to be sampled.
5. Squeeze the aspirator bulb several times to draw the sample from the remote location to the sensor compartment. Allow one squeeze of the bulb for every one foot of sampling hose for the sample to reach the sensors. Continue to squeeze the bulb for an additional 45 seconds or until readings stabilize.

6. Note the gas measurement readings.
CAUTION: Hand aspirated remote sampling only provides continuous gas readings for the area in which the probe is located when the bulb is being continuously squeezed.

Note: Each time a reading is desired, it is necessary to squeeze the bulb a sufficient number of times to bring a fresh sample to the sensor compartment and to continue to squeeze the bulb until readings stabilize.

3. Calibration

The ToxiPro features fully automated fresh air/zero and span calibration functions. The

MODE button is used to initiate the automatic calibration sequence. Calibration adjustments are made automatically by the instrument.

3.1 Verification of accuracy

3.1.1 Verifying accuracy and response: ToxiPro O₂

To verify the accuracy of the ToxiPro O₂, take the ToxiPro O₂ to an area where the atmosphere is known to be fresh and check the readings. If the readings differ from those expected in fresh air (oxygen monitors should read 20.9% in fresh air), then a fresh air/zero calibration adjustment must be made as discussed below in section 3.3. If fresh air is not available, see section 3.7 below for instructions for calibrating the ToxiPro O₂ in contaminated air.

Honeywell Analytics also recommends that the response of the oxygen sensor be regularly verified by any of these methods:

- Expose the O₂ sensor to a known concentration of gas containing less than 19.0% oxygen. If the descending oxygen alarm is set to 19.5% the instrument should go into alarm a few seconds after the gas reaches the sensor face.
- Process the ToxiPro O₂ in an IQ Express Dock that has a cylinder of calibration gas containing 18.0% oxygen (or less) connected to the gas port and proceed with the oxygen bump test.
- Breath test: Hold your breath for 10 seconds, then **slowly** exhale directly onto the face of the sensor (in the same way you would to fog up a piece of glass). If the descending oxygen alarm is set to 19.5%, the instrument should go into alarm after a few seconds.

3.1.2 Verifying accuracy: ToxiPro with toxic gas sensor

Verification of accuracy is a two-step procedure for ToxiPro instruments equipped with a toxic gas sensor:

Step one is to take the ToxiPro to an area where the atmosphere is known to be fresh and check the readings. If the readings differ from those expected in fresh air (instruments equipped with a toxic sensor should read 0 PPM in fresh air), then a fresh air calibration adjustment must be made as discussed below in section 3.3.

Step two is to test sensor response by exposing the sensor to a test gas of known concentration. This is known as a functional (bump) test. Readings are considered to be accurate when the display is between 90% and 120% of the expected values as given on

the calibration gas cylinder. If readings are accurate, there is no need to adjust your gas detector. See section 3.4 for further details concerning the functional/bump test. If the readings are inaccurate, the instrument must be span calibrated before further use as discussed in section 3.5.

⚠WARNING The accuracy of ToxiPro instruments equipped with toxic gas sensors should be checked periodically with known concentration calibration gas. Failure to check accuracy can lead to inaccurate and potentially dangerous readings.

See Appendix C for a discussion of calibration frequency recommendations.

3.2 Effect of contaminants on ToxiPro sensors

The atmosphere in which the ToxiPro is used can have lasting effects on the sensors. Sensors may suffer losses in sensitivity leading to degraded performance if exposed to certain substances.

The ToxiPro O₂ uses a galvanic oxygen sensor, while toxic sensor versions of the ToxiPro use an electrochemical toxic gas sensor. Different types of sensors use different detection principles, so the conditions that affect the accuracy of the sensors vary from one type of sensor to the next.

3.2.1 Effects of contaminants on O₂ sensors

Oxygen sensors may be affected by prolonged exposure to "acid" gases such as carbon dioxide. The oxygen sensors used in Honeywell Analytics instruments are not recommended for continuous use in atmospheres containing more than 25% CO₂.

3.2.2 Effects of contaminants on toxic gas sensors

Honeywell Analytics's "substance-specific" electrochemical sensors have been carefully designed to minimize the effects of common interfering gases. "Substance-specific" sensors are designed to respond only to the gases that they are supposed to measure. The higher the specificity of the sensor, the less likely the sensor will react to other gases, which may be incidentally present in the environment. For instance, a "substance-specific" carbon monoxide sensor is deliberately designed not to respond to other gases that may be present at the same time, such as hydrogen sulfide (H₂S) and methane (CH₄).

Although great care has been taken to reduce cross-sensitivity, some interfering gases may

still have an effect on toxic sensor readings. In some cases the interference may be positive and result in readings that are higher than actual. In other cases the interference may be negative and produce readings that are lower than actual and may even cause the instrument to display negative readings for the target gas.

See Appendix A for cross-sensitivity data.

3.3 Fresh air/zero calibration

To initiate the fresh air/zero calibration:

1. From the current gas reading screen, press the MODE button three times within two seconds to begin the fresh air/zero calibration sequence. The ToxiPro will briefly display "CAL" and then begin a 5-second countdown with the 0-CAL icon lit.

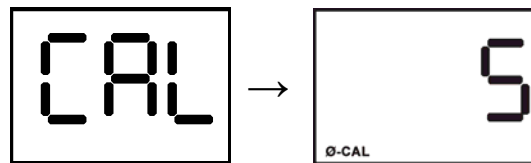

2. Press the MODE button before the end of the 5-second countdown to begin the fresh air/zero calibration. The fresh air/zero calibration has been successfully initiated when the ToxiPro alternates between the following two screens:

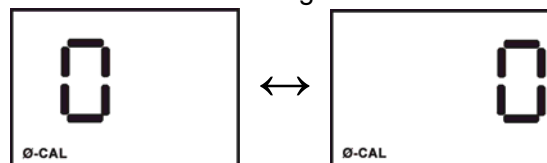

3. For instruments equipped with a toxic gas sensor, the fresh air/zero calibration is complete when the instrument begins a second 5-second countdown for the span calibration. If span calibration is not required, allow the countdown to reach 0 without pressing the MODE button. For further instructions concerning the span calibration of toxic sensor-equipped models, proceed to section 3.5.

For ToxiPro O₂ models, calibration is complete when the instrument returns to the current gas readings screen. If the fresh air/zero calibration attempt fails, proceed to section 3.6.1.

⚠WARNING Fresh air/zero calibrations may only be performed in an atmosphere that is known to contain 20.9% oxygen and 0 PPM toxic gas. Performing the fresh air/zero calibration in an atmosphere that is not comprised of 20.9% oxygen and 0 PPM toxic gas may lead to inaccurate and potentially dangerous readings.

3.4 Functional (bump) testing (toxic sensor versions)

The accuracy of ToxiPro instruments may be verified at any time by a simple functional (bump) test. To perform a functional (bump) test, do the following:

1. Turn the ToxiPro on and wait at least three minutes to allow the readings to fully stabilize. If the sensor has just been replaced, it must be allowed to stabilize prior to performing a functional (bump) test. See section 4.2 for further details.
2. Make sure the instrument is located in fresh air.
3. Verify that the current gas readings match the concentrations present in fresh air. The reading for toxic gases should be 0 parts-per-million (PPM) in fresh air. If the reading is anything other than 0 PPM proceed to section 3.3 and perform a fresh air/zero calibration before continuing.
4. Apply the calibration gas as shown in figure 3.4.

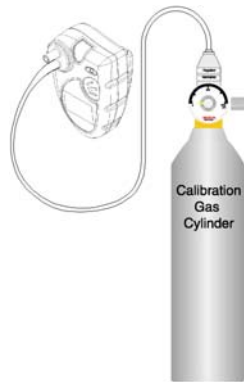

Figure 3.4:
Proper bump-test/span calibration set-up for toxic sensor-equipped instruments.

Note: ToxiPro instruments equipped with a chlorine dioxide (ClO₂) sensor require a chlorine dioxide generator as a calibration gas source.

5. Wait for the readings to stabilize. (Forty-five seconds to one minute is usually sufficient.)
6. Note the readings. Readings are considered accurate if they are between 90% and 120% of the expected value. If the readings are considered accurate, then the instrument may be used without further adjustment. If readings are considered inaccurate, the instrument must be adjusted using the “span” calibration procedures discussed in section 3.5 before further use.

3.5 Span Calibration (toxic sensor versions)

Span calibration should be performed when a functional (bump) test has shown that the

instrument’s gas readings are not between 90% and 120% of the expected values as given on the calibration gas cylinder (as discussed in section 3.4). Prior to performing a span calibration, perform a fresh air/zero calibration as discussed in section 3.3. After successful completion of the fresh air/zero calibration, the instrument will begin a second five-second countdown with the calibration gas bottle icon highlighted.

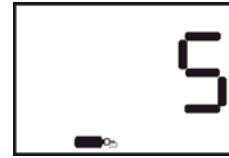

1. Press the MODE button before the countdown is complete to initiate the span calibration. The display will alternate between “GAS” and the expected concentration of calibration gas.

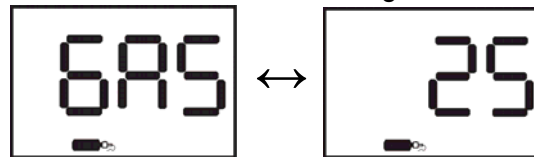

2. Apply calibration gas as shown above in figure 3.4. Once calibration gas is detected, the readout will change to show the gas reading. Note that the negated horn symbol is shown at lower left to indicate that the alarms are not operating because the instrument is in calibration mode.

Note: ToxiPro instruments equipped with a chlorine dioxide (ClO₂) sensor require a chlorine dioxide generator as a calibration gas source.



3. The calibration is fully automatic from this point on. Once the instrument successfully completes the span calibration, it will emit three short beeps and display the maximum span calibration adjustment value for two seconds.



Note: The maximum span calibration adjustment value shown is an indication of the relative health of the sensor. As a sensor loses sensitivity, the maximum adjustment level will approach the calibration gas concentration, letting you know when the sensor is losing

sensitivity. Once the maximum span adjustment descends to within 10% of the calibration gas concentration, it is time to order a new sensor.

- Following successful calibration, the instrument will display the gas reading with the negated horn icon until the reading drops below the alarm threshold.

Disconnect the calibration assembly immediately after calibration.

⚠WARNING Use of non-standard calibration gas and/or calibration kit components when calibrating the ToxiPro can lead to inaccurate and potentially dangerous readings, and may void the standard Honeywell Analytics Gas Detection Warranty.

3.6 Failure to calibrate

3.6.1 Fresh air/zero calibration failure

In the event of fresh air/zero calibration failure, the “no” and “CAL” screens will be alternately displayed as shown below with the “0-CAL” segment lit. The instrument will then return to the gas reading screen.

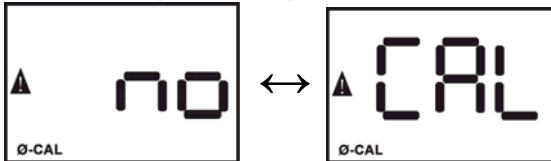

Following a fresh air/zero calibration failure, the triangular warning symbol will be lit and the “0-CAL” indicator will flash until a successful fresh air/zero calibration is performed.



3.6.1.1 Causes of fresh air/zero calibration failures

Fresh air/zero calibration failures often result from the attempt to calibrate the instrument in a contaminated atmosphere.

Fresh air/zero calibration failures in the ToxiPro O₂ can also result from an oxygen sensor that has failed.

3.6.1.2 Forced fresh air/zero calibration

If a fresh air/zero calibration fails in an atmosphere known to be fresh, the ToxiPro can be forced to fresh air calibrate as follows.

- Follow instructions 1 and 2 in section 3.3 to begin the fresh air/zero calibration sequence.
- As soon as the alternating right and left

0's are shown on the screen, press and hold the MODE button.

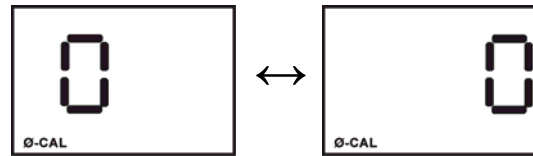

- The forced fresh air/zero calibration is complete when the instrument emits three short beeps and then moves on to the span calibration procedure.

⚠WARNING Performing the forced fresh air calibration in a contaminated atmosphere will lead to inaccurate and potentially dangerous readings.

3.6.2 Span calibration failure

The ToxiPro is designed to recognize two distinct types of span calibration failures: failures that occur due to sensor response outside the sensor's normal range for calibration and failures that occur when the instrument fails to recognize any calibration gas whatsoever.

3.6.2.1 Sensor out of range (no CAL)

If the instrument recognizes calibration gas, but the sensor response is not within the range to calibrate the instrument, span calibration will fail and the “no” and “CAL” screens will be alternately displayed.

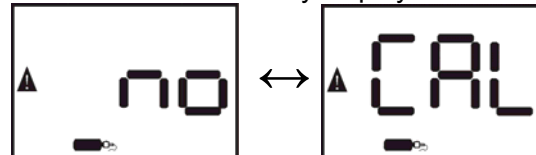

After displaying “no” and “CAL” times, the instrument will return to the current gas readings screen and the warning symbol and the calibration bottle icon will be shown, which signifies that the instrument failed the last attempt to span calibrate.



Note: If the Calibration Due Lockout is enabled, the ToxiPro will turn itself off following a failed calibration attempt.

3.6.2.2 Causes for span cal failure

Span calibration failures can be caused by:

- Expired calibration gas.
- Calibration gas whose concentration fails to match the concentration expected by the instrument.
- Inappropriate regulator. The ToxiPro must be calibrated using a 1.0 liter/minute fixed flow regulator.
- Sensor failure.

3.7 Fresh air/zero calibration in a contaminated atmosphere

To perform a fresh air calibration in a contaminated atmosphere, it is necessary to use special calibration gas, whose composition is identical to that of fresh air. Honeywell Analytics offers the “Zero Air” calibration gas cylinder as part number 54-9039, which contains 0 PPM toxic gas and 20.9% oxygen.

1. Apply “Zero Air” calibration gas to the instrument as shown above in figure 3.4 for at least 15 seconds or until the readings fully stabilize.
2. Perform the fresh air/zero calibration procedure as described in section 3.3 while continuing to flow gas to the sensor.
3. Once the fresh air/zero calibration is complete, disconnect the calibration assembly. If the ToxiPro is equipped with a toxic gas sensor, proceed to the span calibration procedure if necessary as described in section 3.5.

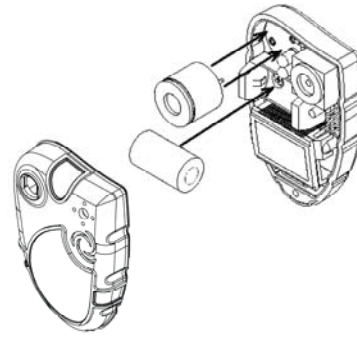

5. Install the new battery. Be sure to align the polarity of the battery in accordance with the diagram on the face of the battery compartment.

⚠WARNING Use only Panasonic #CR2 in the ToxiPro.

6. Once the new battery is installed, the instrument will automatically restart and the ToxiPro will show “F 0” on the display and will beep 6 times upon startup. It will then go into the set time/date mode.

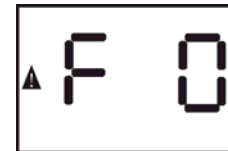

4. Maintenance

4.1 Replacing batteries

⚠WARNING Removal or replacement of the lithium battery in potentially combustible atmospheres may compromise intrinsic safety. The lithium battery used in the ToxiPro may only be removed or replaced in an atmosphere that is known to be free of combustible gas.

To replace the battery:

1. Turn the ToxiPro off. If the ToxiPro is in Always On Mode, see section 2.8.1 for further instructions.

Note : Failure to turn the ToxiPro off prior to battery removal may cause loss of data in the ToxiPro’s datalogger.

2. Remove the two screws from the back of the ToxiPro. One is located under the clip. The other is located near the bottom of the instrument.
3. Remove the front housing. The main board will stay attached to the rear instrument housing. The battery is located directly above the display.
4. Remove the old lithium battery. If necessary, use a small screwdriver to gently pry the battery out.

Figure 4.1: Interior view with battery and sensor removed.

The next five steps describe programming the time and date.

7. Press and release the MODE button to advance the setting by one. Hold the MODE button down to scroll rapidly. Afternoon and evening hours are differentiated by a dot below the colon on the display.



10 a.m.



10 p.m.

Once the appropriate hour setting is shown, wait 5 seconds and the minutes setting will start to blink.

8. Adjust the minutes setting with the MODE button, then wait 5 seconds and the months setting will be shown.
9. Adjust the months setting with the MODE button, then wait 5 seconds and the days setting will be shown.
10. Adjust the days setting with the MODE button,

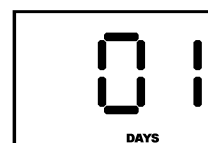
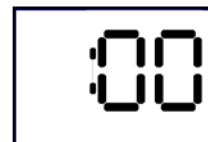

then wait 5 seconds and the year setting will be shown in two digit format.

11. Enter the last two digits of the year with the MODE button, then wait 5 seconds and the instrument will continue to the normal start up sequence as discussed in section 2.1.



12. Replace the front cover plate.
13. Reinstall the screws that were removed in step 1.
14. The ToxiPro must be calibrated following replacement of the battery. Once the sensor has stabilized, calibrate the detector. For ToxiPro O₂ units, perform the Fresh Air/Zero Calibration as described in section 3.3. For ToxiPro units, perform both the Fresh Air/Zero calibration (section 3.3) and the Span calibration (section 3.5).

4.2 Replacing sensors

⚠WARNING Removal or replacement of the lithium battery or sensor in potentially combustible atmospheres may compromise intrinsic safety. The lithium battery or sensor used in the ToxiPro may only be removed or replaced in an atmosphere that is known to be free of combustible gas.

The sensor in the ToxiPro may require periodic replacement. To replace the sensor:

1. Follow the directions in section 4.1 steps 1-3 to remove the front housing.
2. The sensor is located to the left of the LED alarm light on the main board. Gently remove the old sensor and install a new sensor of the same type.
3. New sensors must be allowed to stabilize prior to use according to the following schedule. The detector must be powered off and functional batteries must be installed for the sensors to stabilize.

Instrument	Stabilization Period
ToxiPro O ₂	1 hour
ToxiPro with toxic gas sensor	15 minutes

4. Once the sensor has stabilized, calibrate the detector. For ToxiPro O₂ units, perform the Fresh Air/Zero Calibration as described in section 3.3. For ToxiPro units with toxic gas sensors, perform both the Fresh Air/Zero calibration (section 3.3) and the Span calibration (section 3.5).

Note: The ToxiPro must be calibrated after any sensor change. See section 3.3 and 3.5 above for details.

4.3 Proper Cleaning

The exterior surfaces of the ToxiPro may be cleaned using a damp cloth only. Do not use cleaning agents of any kind. The introduction of cleaning agents to the detector may affect instrument functionality.

4.4 Storage

ToxiPro detectors may be stored for long periods in a fresh air environment at temperatures between 10°C/50°F and 30°C/86°F.

5. PC-Instrument Communications

5.1 Event logging

Each ToxiPro includes a built-in event logger that stores instrument readings during alarm conditions, calibration values and other data. BioTrak software and an IrDA port are necessary to download the collected data to a PC. See section 5.3 for instructions on initiating communications.

Warning, Danger, Custom, STEL and TWA alarms are logged as events.

The event logger in ToxiPro version 9.20 or greater logs will nest events. The word “nested” in this case refers to the logging of multiple events simultaneously. When the instrument goes from Warning to Danger alarm condition then both Warning and Danger alarms are being logged as separate events.

Note: In ToxiPro versions less than 9.20 a single event would be logged for a Danger event and Custom alarms are not supported. Even though latching is enabled, the event logger only logs the actual time the instrument is in alarm condition and not the duration for which the alarm was latched.

Since the Warning alarm level is less than/equal to the Danger alarm level and the custom alarm level is greater than/equal to the danger alarm level for all sensors except oxygen, the sequence of these events usually is Warning -> Danger -> Custom.

When the instrument goes into a warning alarm condition the event logger starts recording data for the warning event. When the instrument goes into danger alarm condition, since the gas level is still greater than the warning condition the event logger is logging data for both warning and danger alarms. And when the instrument goes into the custom alarm condition the event logger is then logging data for 3 different event types: - warning, danger and custom. When the gas level goes drops below custom alarm level

the custom event would finish first, followed by the danger and then warning. For oxygen units the custom alarm value is always less than the danger alarm. So the sequence of events would be danger->custom. STEL and TWA events are not valid for an oxygen instrument.

Eventlogger Capacity

The capacity of the event logger is 100 events. If the capacity is exceeded, the memory will “wrap”. The word “wrap” refers to deleting the oldest event and replace it with the newest event. It is recommend to download the instrument’s datalogger on a regular basis to prevent data loss due to wrapping.

5.2 Instrument firmware upgrades

The ToxiPro’s instrument firmware may be upgraded at any time with a PC through the instrument’s IrDA port. See section 5.3 for instructions on initiating communications.

For the latest version of the instrument firmware see the Honeywell Analytics download website at <http://www.biodownloads.com>

5.3 Initiating communications

To initiate communications, hold the MODE button as if you are turning the instrument off. Once “OFF” or “on” is shown, continue to hold MODE until the “IrdA” screen is shown and the LED/IrDA port turns on.

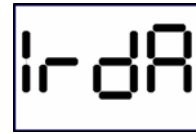

Once “IrdA” is shown release the MODE button. Then align the infrared port at the top front of the ToxiPro with the PC’s infrared port to proceed with the download. The LED/IrDA port will blink during communication with the PC. The ToxiPro should be located 1-2” (2.5-5cm) from the IrDA Port.

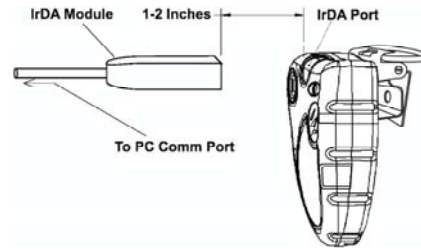

Proper Positioning of IrDA Module

6. Exploded view and basic parts list

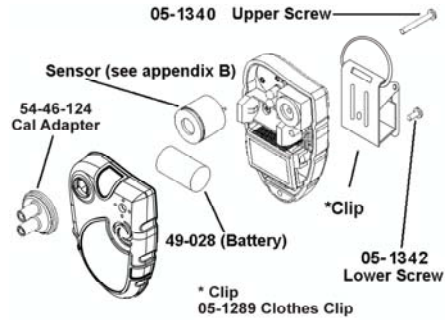

Appendices

Appendix A: Sensor Cross-Sensitivity Chart

The table below provides the cross-sensitivity response of the ToxiPro toxic gas sensors to common interference gases. The values are ToxiPro as a percentage of the primary sensitivity, or the reading of the sensor when exposed to 100ppm of the interfering gas at 20°C. These values are approximate. The actual values depend on the age and condition of the sensor. Sensors should always be calibrated to the primary gas type. Cross-sensitive gases should not be used as sensor calibration surrogates without the written consent of Honeywell Analytics.

SENSOR	CO	H ₂ S	SO ₂	NO	NO ₂	Cl ₂	ClO ₂	H ₂	HCN	HCl	NH ₃	C ₂ H ₄	C ₂ H ₂
Carbon Monoxide (CO)	100	10	5	10	-15	-5	-15	50	15	3	0	75	250
Carbon Monoxide (CO+)	100	350	50	30	-60	-60	-120	50	n/d	n/d	0	75	250
Carbon Monoxide (CO-H)	100	10	5	n/d	(-)	(-)	(-)	5	n/d	n/d	n/d	(+)	(+)
Hydrogen Sulfide (H ₂ S)	0.5	100	20	2	-20	-20	-60	0.2	0	0	0	n/d	n/d
Sulfur Dioxide (SO ₂)	1	1	100	1	-100	-50	-150	0.2	n/d	n/d	0	(+)	(+)
Nitrogen Dioxide (NO ₂)	-5	-8	-1	0	100	90	270	0	n/d	n/d	0	n/d	n/d
Chlorine (Cl ₂) (specific)	0	-3	0	n/d	12	100	20	0	0	0	0	0	0
Chlorine Dioxide (ClO ₂) (specific)	0	-25	0	n/d	n/d	60	100	0	0	0	n/d	0	0
Ammonia (NH ₃) (54-47-21)	0	<5	0	n/d	0	0	n/d	0	0	0	100	0	0
Phosphine (PH ₃)	0.5	25	20	n/d	(-)	(-)	(-)	0.1	n/d	n/d	n/d	1	0.5
Hydrogen Cyanide(HCN)	0.5	350	160	-5	-100	-20	-60	0.1	100	65	-5	50	n/d

n/d = no data, (+) undetermined positive, (-) undetermined negative

Appendix B: Replacement Sensor List

Part No.	Sensor Description	Range	Resolution
54-47-90	O ₂ Oxygen (2 years) (for ToxiPro O ₂)	0– 30%/Vol.	0.1%/Vol.
54-47-01	CO Carbon monoxide	0 – 999 PPM	1 PPM
54-47-02	H ₂ S Hydrogen sulfide	0 – 200 PPM	1 PPM
54-47-03	SO ₂ Sulfur dioxide	0 – 100 PPM	0.1 PPM
54-47-05	CO+ Carbon monoxide plus	0 – 999 PPM	1 PPM
54-47-09	NO ₂ Nitrogen Dioxide	0 – 20 PPM	0.1 PPM
54-47-10	HCN Hydrogen cyanide	0 – 100 PPM	0.1 PPM
54-47-13	PH ₃ Phosphine	0 – 20 PPM	0.01 PPM
54-47-18	Cl ₂ Chlorine	0 – 20 PPM	0.1 PPM
54-47-19	CO-H Carbon monoxide minus	0 – 999 PPM	1 PPM
54-47-20	ClO ₂ Chlorine dioxide	0 – 5 PPM	0.01 PPM
54-47-21	NH ₃ Ammonia	0 – 100 PPM	1 PPM

Appendix C: Calibration Frequency

Recommendation

One of the most common questions that we are asked at Honeywell Analytics is: **“How often should I calibrate my gas detector?”**

Sensor Reliability and Accuracy

Today’s sensors are designed to provide years of reliable service. In fact, many sensors are designed so that with normal use they will only lose 5% of their sensitivity per year or 10% over a two-year period. Given this, it should be possible to use a sensor for up to two full years without significant loss of sensitivity.

Verification of Accuracy

With so many reasons why a sensor can lose sensitivity and given the fact that dependable sensors can be key to survival in a hazardous environment, frequent verification of sensor performance is paramount.

There is only one sure way to verify that a sensor can respond to the gas for which it is designed. That is to expose it to a known concentration of target gas and compare the reading with the concentration of the gas. This is referred to as a “bump” test. This test is very simple and takes only a few seconds to accomplish. **The safest course of action is to do a “bump” test prior to each day’s use.** It is not necessary to make a calibration adjustment if the readings fall between 90%* and 120% of the expected value. As an example, if a CO sensor is checked using a gas concentration of 50 PPM it is not necessary to perform a calibration unless the readings are either below 45 PPM or above 60 PPM.

***The Canadian Standards Association (CSA) requires combustible gas sensors to undergo calibration when the displayed value during a bump test fails to fall between 100% and 120% of the expected value for the gas.**

Lengthening the Intervals between Verification of Accuracy

We are often asked whether there are any circumstances in which the

period between accuracy checks may be lengthened.

Honeywell Analytics is not the only manufacturer to be asked this question! One of the professional organizations to which Honeywell Analytics belongs is the Industrial Safety Equipment Association (ISEA). The “Instrument Products” group of this organization has been very active in developing a protocol to clarify the minimum conditions under which the interval between accuracy checks may be lengthened.

A number of leading gas detection equipment manufacturers have participated in the development of the ISEA guidelines concerning calibration frequency. Honeywell Analytics’s procedures closely follow these guidelines.

If your operating procedures do not permit daily checking of the sensors, Honeywell Analytics recommends the following procedure to establish a safe and prudent accuracy check schedule for your Honeywell Analytics instruments:

1. During a period of initial use of at least 10 days in the intended atmosphere, check the sensor response daily to be sure there is nothing in the atmosphere that is poisoning the sensor(s). The period of initial use must be of sufficient duration to ensure that the sensors are exposed to all conditions that might have an adverse effect on the sensors.
2. If these tests demonstrate that it is not necessary to make adjustments, the time between checks may be lengthened. The interval between accuracy checking should not exceed 30 days.
3. When the interval has been extended the toxic and combustible gas sensors should be replaced immediately upon warranty expiration. This will minimize the risk of failure during the interval between sensor checks.
4. The history of the instrument response between verifications should be kept. Any conditions, incidents, experiences, or exposure to

contaminants that might have an adverse effect on the calibration state of the sensors should trigger immediate re-verification of accuracy before further use.

5. Any changes in the environment in which the instrument is being used, or changes in the work that is being performed, should trigger a resumption of daily checking.
6. If there is any doubt at any time as to the accuracy of the sensors, verify the accuracy of the sensors by exposing them to known concentration test gas before further use.

Gas detectors used for the detection of oxygen deficiencies, flammable gases and vapors, or toxic contaminants must be maintained and operated properly to do the job they were designed to do. Always follow the guidelines provided by the manufacturer for any gas detection equipment you use!

If there is any doubt regarding your gas detector’s accuracy, do an accuracy check! All it takes is a few moments to verify whether or not your instruments are safe to use.

One Button Auto Calibration

While it is only necessary to do a “bump” test to ensure that the sensors are working properly, all current Honeywell Analytics gas detectors offer a one-button auto calibration feature. This feature allows you to calibrate a Honeywell Analytics gas detector in about the same time as it takes to complete a “bump” test. The use of automatic bump test and calibration stations can further simplify the tasks, while automatically maintaining records.

**Don’t take a chance
with your life.
Verify accuracy frequently!**

Please read also Honeywell Analytics’s application note: AN20010808 “Use of ‘equivalent’ calibration gas mixtures”. This application note provides procedures to ensure safe calibration of LEL sensors that are subject to silicone poisoning.

Honeywell Analytics Warranty Gas Detection Products

General

Honeywell Analytics, Inc. products manufactured in Middletown, CT (hereafter Honeywell) warrants gas detectors, sensors and accessories manufactured and sold by Honeywell, to be free from defects in materials and workmanship for the periods listed in the tables below.

Damages to any Honeywell products that result from abuse, alteration, power fluctuations including surges and lightning strikes, incorrect voltage settings, incorrect batteries, or repair procedures not made in accordance with the Instrument's Reference Manual are not covered by the Honeywell warranty.

The obligation of Honeywell under this warranty is limited to the repair or replacement of components deemed by the Honeywell Instrument Service Department to have been defective under the scope of this standard warranty. To receive consideration for warranty repair or replacement procedures, products must be returned with transportation and shipping charges prepaid to Honeywell at its manufacturing location in Middletown, Connecticut, or to a Honeywell Authorized Warranty Service Center. It is necessary to obtain a return authorization number from Honeywell prior to shipment.

THIS WARRANTY IS EXPRESSLY IN LIEU OF ANY AND ALL OTHER WARRANTIES AND REPRESENTATIONS, EXPRESS OR IMPLIED, INCLUDING BUT NOT LIMITED TO, THE WARRANTY OF FITNESS FOR A PARTICULAR PURPOSE. HONEYWELL WILL NOT BE LIABLE FOR LOSS OR DAMAGE OF ANY KIND CONNECTED TO THE USE OF ITS PRODUCTS OR FAILURE OF ITS PRODUCTS TO FUNCTION OR OPERATE PROPERLY.

Instrument & Accessory Warranty Periods

Product(s)	Warranty Period
PHD6™, Cannonball3™	As long as the instrument is in service
ToxiPro®, MultiPro™	2 years from date of purchase
ToxiLtd®	2 years after activation or 2 years after the "Must Be Activated By" date, whichever comes first
Battery packs and chargers, sampling pumps and other components, which by their design are consumed or depleted during normal operation, or which may require periodic replacement	One year from the date of purchase

Sensor Warranty Periods

Instrument(s)	Sensor Type(s)	Warranty Period
PHD6™, Cannonball3™, MultiPro™, ToxiPro®	O ₂ , LEL**, CO, CO+, H ₂ S & Duo-Tox	2 Years
	All Other Sensors	1 Year
All Others	All Sensors	1 Year

** Damage to combustible gas sensors by acute or chronic exposure to known sensor poisons such as volatile lead (aviation gasoline additive), hydride gases such as phosphine, and volatile silicone gases emitted from silicone caulks/sealants, silicone rubber molded products, laboratory glassware greases, spray lubricants, heat transfer fluids, waxes & polishing compounds (neat or spray aerosols), mold release agents for plastics injection molding operations, waterproofing formulations, vinyl & leather preservatives, and hand lotions which may contain ingredients listed as cyclomethicone, dimethicone and polymethicone (at the discretion of Honeywell's Instrument Service department) void Honeywell Analytics's Standard Warranty as it applies to the replacement of combustible gas sensors.